

CATALOG 25

30 years



**POSI<sup>+</sup>-TECH**

POSITIVE TECHNOLOGIES, INC.

Electrical Hardware for the Professional

 [www.posi-tech.com](http://www.posi-tech.com)





**POSI-TECH**  
Positive Technologies, Inc.  
Electrical Hardware for the Professional

**HOURS OF OPERATION**

**Monday - Friday, 8am - 5pm Eastern Time**



**PHONE**  
**800-548-6728**  
LOCAL: 813-246-4828



**FAX**  
**800-457-5156**  
LOCAL: 813-246-4629



**ORDERS: SALES@POSI-TECH.COM**  
**ACCOUNTING: AR@POSI-TECH.COM**



**OFFICES AND DISTRIBUTION CENTER**  
3719 Corporex Park Drive  
Suite 200  
Tampa, FL 33619  
**ACCOUNTING**  
PO Box 213  
San Antonio, FL 33576

**ABOUT US**

Established in 1989, Positive Technologies, Inc. is a family owned and operated manufacturer and supplier of quality electrical connectors and fasteners. From our distribution center in Tampa, Florida, we provide quality products to wholesalers across the United States.

**SOLD EXCLUSIVELY TO AUTHORIZED DISTRIBUTORS**

All trademarks, aside from those owned by Positive Technologies, Inc., are the property of their respective owners. Positive Technologies, Inc. has made every attempt to correctly identify these trademarks and at no time assumes to represent these trademarks as their own.

Posi-tech 800-548-6728 Fax: 800-457-5156 email: sales@posi-tech.com  
Copyright Positive Technologies, Inc 2018

**TABLE OF CONTENTS**



SPLIT BOLTS	2-3
COMPRESSION LUGS	4-16
MECHANICAL LUGS	17-23
INSULATED TAPS	24-28
GROUNDING CLAMPS	29-33
BOX HARDWARE	34-37
SOLDERLESS TERMINALS	38-54
WIRE CONNECTORS	55-62
SIGNAGE AND LABELS	64-65
CABLE TIES	66-70
CABLE MANAGEMENT	71-73
SHRINK TUBING	74-80
TAPE PRODUCTS	81-87
FIRESTOP & CHEMICALS	88-98
ROPE AND TWINE	99-100
PPE / SAFETY	101-104
VOICE AND DATA	105-110
TOOLS AND SUPPLIES	111-115
HOLE SAWS AND BLADES	116-117
CUTTING TOOLS	118-124
BITS AND DRIVERS	125-127
CONDUIT STRAPS AND FITTINGS	128-130
STAPLES	131-134
ROD AND SUPPORT FIXTURES	135-136
ENCLOSURE HARDWARE	137
STRUT ACCESSORIES AND HARD	138-141
ANCHORS	142-157
FASTENERS	158-174
APPENDIX	175-176
INDEX	177-182



# SPLIT BOLTS



## COPPER TO COPPER



Compact, high strength, high copper alloy split-bolt has free running threads and easy to grip wrench flats. Highly resistant to seasonal cracking and corrosion, our split bolt provides maximum pressure and assures a secure connection on all combinations of run and tap conductors.



PART NO	CROSS FLATS	L	W	WIRE RANGE	RECOMMENDED TIGHTENING TORQUE IN-LB
SBCU-0010	.50	.85	.38	12 STR. - 10 STR.	80
SBCU-0008	.50	.85	.38	10 STR. - 8 STR.	80
SBCU-0006	.63	1.14	.45	8 STR. - 6 SOL.	165
SBCU-0004	.69	1.20	.51	8 STR. - 4 SOL.	165
SBCU-0003	.75	1.50	.60	6 STR. - 2 SOL.	165
SBCU-0002	.82	1.54	.62	6 STR. - 2 SOL.	275
SBCU-1000	.94	1.77	.73	4 STR. - 1/0 STR.	385
SBCU-2000	1.05	1.94	.82	2 STR. - 2/0 STR.	385
SBCU-3000	1.36	1.86	1.17	1 STR. - 3/0 STR.	500
SBCU-250M	1.36	2.07	1.17	1 STR. - 250 MCM	650
SBCU-350M	1.70	2.51	1.41	1/0 STR. - 350 MCM	650
SBCU-500M	1.82	2.79	1.48	2/0 STR. - 500 MCM	825
SBCU-750M	2.31	3.29	1.94	4/0 STR. - 750 MCM	1000
SBCU-100M	2.56	3.73	2.19	300 MCM - 1000 MCM	1100

Listed torque values are for maximum conductor combinations accommodated. Consult UL486 Tables 7-4, 7-5, 7-6 for smaller conductor combinations. All wire sizes, unless noted otherwise, are American Wire Gauge (AWG)

## COPPER TO COPPER 3-WIRE



Compact, high strength, high copper alloy split-bolt has free running threads and easy to grip wrench flats. Highly resistant to seasonal cracking and corrosion, our split bolt provides maximum pressure and assures a secure connection on all combinations of run and tap conductors.

PART NO	CROSS FLATS	L	W	WIRE RANGE	RECOMMENDED TIGHTENING TORQUE IN-LB
SBCU-0006-3	.62	1.05	.70	8 STR. - 6 SOL.	165
SBCU-0004-3	.68	1.30	.78	8 STR. - 4 SOL.	165
SBCU-0003-3	.74	1.51	.84	6 STR. - 2 SOL.	165

Not UL Listed  
All wire sizes, unless noted otherwise, are American Wire Gauge (AWG)



Visit us on the web at [www.posi-tech.com](http://www.posi-tech.com)



# SPLIT BOLTS

## DUAL RATED - ALL COMBINATIONS



Tin-plated, high strength, copper alloy split-bolt with spacer. Spacer separates dissimilar conductors and provides long contact length that prevents high pressure point contacts between run and tap conductors. Use of CUAL joint compound recommended with Aluminum and ACSR



Copper Only



PART NO	CROSS FLATS	L	W	WIRE RANGE	RECOMMENDED TIGHTENING TORQUE IN-LB
SBUN-0006	.62	.92	.42	12 STR. - 6 SOL.	165
SBUN-0004	.69	1.05	.48	10 SOL. - 4 SOL.	165
SBUN-0003	.74	1.25	.57	10 SOL. - 2 SOL.	275
SBUN-0002	.81	1.48	.59	8 STR. - 2 SOL.	275
SBUN-1000	.93	1.77	.70	2 STR. - 1/0 STR.	385
SBUN-2000	1.04	1.93	.79	2 STR. - 2/0 STR.	385
SBUN-3000	1.38	2.34	1.12	1 STR. - 3/0 STR.	500
SBUN-250M	1.38	2.50	1.58	1 STR. - 250 MCM	650
SBUN-350M	1.69	2.88	1.36	1/0 STR. - 350 MCM	650
SBUN-500M	2.00	3.12	1.47	400 MCM - 500 MCM	825

All wire sizes, unless noted otherwise, are American Wire Gauge (AWG)  
UL listed for Copper connections only

## DUAL RATED - ALUMINUM AND COPPER (UL)



- No scratch brushing required
- No oxide inhibitor require
- Orients the conductor
- Provides maximum pressure and assures a secure connection of run and tap conductors
- Facilitates piercing the aluminum conductor surface oxides

- UL 486B listed, 90°C rated
- Provides a low contact resistance
- Provides equal coefficient of expansion
- Inhibits the reformation of oxides by producing a gas-tight seal
- Provides improved retention of minimum to maximum conductor combinations



All Combinations



PART NO	CROSS FLATS	L	W	WIRE RANGE	RECOMMENDED TIGHTENING TORQUE IN-LB
SBAL-0006	.75	1.58	.56	10 SOL. - 6 STR.	165
SBAL-0004	.81	1.38	.62	10 SOL. - 4 SOL.	165
SBAL-0002	.94	1.58	.69	8 STR. - 2 SOL.	275
SBAL-1000	1.00	1.92	.75	8 SOL. - 1/0 STR.	385
SBAL-2000	1.12	1.92	.88	8 STR. - 2/0 STR.	385
SBAL-4000	1.49	2.54	1.13	6 STR. - 4/0 STR.	650
SBAL-350M	1.69	3.24	1.50	4 STR. - 350 MCM	650
SBAL-500M	2.00	3.62	1.73	2 STR. - 500 MCM	825

All wire sizes, unless noted otherwise, are American Wire Gauge (AWG)





# COMPRESSION LUGS



## COPPER - ONE HOLE - STANDARD BARREL



- Inspection window allows for visual verification that the wire has been fully inserted prior to crimping the lug; not recommended in highly corrosive environments as the wire in the barrel is exposed to corrosive elements installed
- Barrel is designed with an internal chamfer at the wire entry to ensure smooth insertion of the wire, preventing possible damaging of the wire strands during insertion
- Short/Standard length barrel is recommended for installations with limited space requirements
- Electro-tin plated unless otherwise specified to reduce galvanic corrosion (bimetallic) and resist corrosive elements
- Connectors are clearly marked with stamping and barrel color coding

PART NO	CONDUCTOR SIZE	STUD SIZE	L	W	DIE INDEX	COLOR
ESR1-0810	8 AWG	#10	1.16	.41	49	RED
ESR1-0814	8 AWG	1/4"	1.26	.44	49	RED
ESR1-0856	8 AWG	5/16"	1.68	.52	49	RED
ESR1-0838	8 AWG	3/8"	1.51	.58	49	RED
ESR1-0812	8 AWG	1/2"	1.76	.71	49	RED
ESR1-0610	6 AWG	#10	1.27	.41	7	BLUE
ESR1-0614	6 AWG	1/4"	1.45	.45	7	BLUE
ESR1-0656	6 AWG	5/16"	1.52	.52	7	BLUE
ESR1-0638	6 AWG	3/8"	1.62	.63	7	BLUE
ESR1-0612	6 AWG	1/2"	1.87	.75	7	BLUE
ESR1-0414	4 AWG	1/4"	1.74	.50	8	GRAY
ESR1-0456	4 AWG	5/16"	1.79	.50	8	GRAY
ESR1-0438	4 AWG	3/8"	1.92	.58	8	GRAY
ESR1-0412	4 AWG	1/2"	2.20	.71	8	GRAY
ESR1-0214	2 AWG	1/4"	1.88	.61	10	BROWN
ESR1-0256	2 AWG	5/16"	1.93	.61	10	BROWN
ESR1-0238	2 AWG	3/8"	2.06	.61	10	BROWN
ESR1-0212	2 AWG	1/2"	2.32	.73	10	BROWN
ESR1-0114	1 AWG	1/4"	1.81	.68	11	GREEN
ESR1-0156	1 AWG	5/16"	1.94	.68	11	GREEN
ESR1-0138	1 AWG	3/8"	2.06	.68	11	GREEN
ESR1-0112	1 AWG	1/2"	2.37	.73	11	GREEN

All wire sizes, unless noted otherwise, are American Wire Gauge (AWG)  
See page 177 (Appendix B) for Flex, DLO and Welding cable conversions.

Continued on Next Page...



UL Listed 90° C  
Up to 35 kV



Visit us on the web at  
[www.posi-tech.com](http://www.posi-tech.com)



# COMPRESSION LUGS



## COPPER - ONE HOLE - STANDARD BARREL



Continued from previous page

PART NO	CONDUCTOR SIZE	STUD SIZE	L	W	DIE INDEX	COLOR
ESR1-1014	1/0	1/4"	1.84	.75	12	PINK
ESR1-1056	1/0	5/16"	1.96	.75	12	PINK
ESR1-1038	1/0	3/8"	2.09	.75	12	PINK
ESR1-1012	1/0	1/2"	2.34	.75	12	PINK
ESR1-2014	2/0	1/4"	1.94	.83	13	BLACK
ESR1-2056	2/0	5/16"	2.06	.83	13	BLACK
ESR1-2038	2/0	3/8"	2.19	.83	13	BLACK
ESR1-2012	2/0	1/2"	2.44	1.02	13	BLACK
ESR1-3056	3/0	5/16"	2.16	.91	14	ORANGE
ESR1-3038	3/0	3/8"	2.29	.91	14	ORANGE
ESR1-3012	3/0	1/2"	2.54	.91	14	ORANGE
ESR1-4056	4/0	5/16"	2.08	1.02	14	PURPLE
ESR1-4038	4/0	3/8"	2.21	1.02	14	PURPLE
ESR1-4012	4/0	1/2"	2.46	1.02	14	PURPLE
ESR1-25M3	250 MCM	3/8"	2.42	1.11	16	YELLOW
ESR1-25M1	250 MCM	1/2"	2.67	1.11	16	YELLOW
ESR1-30M3	300 MCM	3/8"	2.44	1.20	17	WHITE
ESR1-30M1	300 MCM	1/2"	2.69	1.20	17	WHITE
ESR1-35M3	350 MCM	3/8"	2.50	1.29	18	RED
ESR1-35M1	350 MCM	1/2"	2.75	1.29	18	RED
ESR1-40M1	400 MCM	1/2"	3.12	1.40	19	BLUE
ESR1-40M5	400 MCM	5/8"	3.18	1.40	19	BLUE
ESR1-50M1	500 MCM	1/2"	3.12	1.55	20	BROWN
ESR1-50M5	500 MCM	5/8"	3.37	1.55	20	BROWN
ESR1-60M1	600 MCM	1/2"	3.29	1.74	22	GREEN
ESR1-60M5	600 MCM	5/8"	3.54	1.74	22	GREEN
ESR1-75M1	750 MCM	1/2"	3.41	1.91	24	BLACK
ESR1-75M5	750 MCM	5/8"	3.57	1.91	24	BLACK
ESR1-10M5	1000 MCM	5/8"	4.04	2.19	27	WHITE

All wire sizes, unless noted otherwise, are American Wire Gauge (AWG)  
See page 177 (Appendix B) for Flex, DLO and Welding cable conversions.



UL Listed 90° C  
Up to 35 kV





# COMPRESSION LUGS



## COPPER - TWO HOLE - STANDARD BARREL



UL Listed 90° C  
Up to 35 kV

- Inspection window allows for visual verification that the wire has been fully inserted prior to crimping the lug; not recommended in highly corrosive environments as the wire in the barrel is exposed to corrosive elements installed
- Barrel is designed with an internal chamfer at the wire entry to ensure smooth insertion of the wire, preventing possible damaging of the wire strands during insertion
- Short/Standard length barrel is recommended for installations with limited space requirements
- Electro-tin plated unless otherwise specified to reduce galvanic corrosion (bimetallic) and resist corrosive elements
- Connectors are clearly marked with stamping and barrel color coding

PART NO	CONDUCTOR SIZE	STUD SIZE	SPACING CENTER TO CENTER	L	W	DIE INDEX	COLOR
ESR2-0810	8 AWG	#10	5/8"	1.83	.41	49	RED
ESR2-0838	8 AWG	3/8"	1"	2.52	.57	49	RED
ESR2-0812	8 AWG	1/2"	1-3/4"	3.75	.83	49	RED
ESR2-0638	6 AWG	3/8"	1"	2.63	.63	7	BLUE
ESR2-0612	6 AWG	1/2"	1-3/4"	3.87	.42	7	BLUE
ESR2-0414	4 AWG	1/4"	5/8"	2.36	.49	8	GRAY
ESR2-0438	4 AWG	3/8"	1"	2.96	.58	8	GRAY
ESR2-0214	2 AWG	1/4"	5/8"	2.47	.60	10	BROWN
ESR2-0238	2 AWG	3/8"	1"	3.03	.60	10	BROWN
ESR2-0114	1 AWG	5/16"	5/8"	2.51	.68	11	GREEN
ESR2-0138	1 AWG	3/8"	1"	3.07	.68	11	GREEN
ESR2-1014	1/0	1/4"	5/8"	2.64	.75	12	PINK
ESR2-1056	1/0	5/16"	1"	2.85	.75	12	PINK
ESR2-1038	1/0	3/8"	1"	3.10	.75	12	PINK
ESR2-1012	1/0	1/2"	1-3/4"	4.29	.83	12	PINK
ESR2-2014	2/0	1/4"	5/8"	2.64	.83	13	BLACK
ESR2-2056	2/0	5/16"	7/8"	2.95	.83	13	BLACK
ESR2-2038	2/0	3/8"	1"	3.20	.83	13	BLACK
ESR2-2012	2/0	1/2"	1-3/4"	4.39	.83	13	BLACK
ESR2-3038	3/0	3/8"	1"	3.30	.91	14	ORANGE
ESR2-3012	3/0	1/2"	1-3/4"	4.48	.91	14	ORANGE
ESR2-4012	4/0	1/2"	1-3/4"	4.41	1.02	15	PURPLE
ESR2-25M3	250 MCM	3/8"	1"	3.45	1.11	16	YELLOW
ESR2-25M1	250 MCM	1/2"	1-3/4"	4.62	1.11	16	YELLOW

All wire sizes, unless noted otherwise, are American Wire Gauge (AWG)  
See page 177 (Appendix B) for Flex, DLO and Welding cable conversions.

Continued on Next Page...



Visit us on the web at  
[www.posi-tech.com](http://www.posi-tech.com)



# COMPRESSION LUGS



## COPPER - TWO HOLE - STANDARD BARREL



UL Listed 90° C  
Up to 35 kV

PART NO	CONDUCTOR SIZE	STUD SIZE	SPACING CENTER TO CENTER	L	W	DIE INDEX	COLOR
ESR2-30M3	300 MCM	3/8"	1"	3.45	1.20	17	WHITE
ESR2-30M1	300 MCM	1/2"	1-3/4"	4.63	1.20	17	WHITE
ESR2-35M3	350 MCM	3/8"	1"	3.51	1.29	18	RED
ESR2-35M1	350 MCM	1/2"	1-3/4"	4.70	1.29	18	RED
ESR2-40M1	400 MCM	1/2"	1-3/4"	4.88	1.38	19	BLUE
ESR2-50M1	500 MCM	1/2"	1-3/4"	5.06	1.52	20	BROWN
ESR2-60M1	600 MCM	1/2"	1-3/4"	4.36	1.74	22	GREEN
ESR2-75M1	750 MCM	1/2"	1-3/4"	5.36	1.89	24	BLACK
ESR2-75M5	750 MCM	5/8"	1-1/2"	5.17	1.89	24	BLACK
ESR2-10M1	1000 MCM	1/2"	1-3/4"	5.74	2.17	27	WHITE

All wire sizes, unless noted otherwise, are American Wire Gauge (AWG)  
See page 177 (Appendix B) for Flex, DLO and Welding cable conversions.  
UL Listed 90° C, Up to 35 kV

## COPPER BUTT SPLICE - STANDARD BARREL



UL Listed 90° C  
Up to 35 kV

PART NO	CONDUCTOR SIZE	L	OD	DIE INDEX	COLOR
ESBT-0800	8 AWG	1.00	.27	49	RED
ESBT-0600	6 AWG	1.75	.29	7	BLUE
ESBT-0400	4 AWG	1.75	.34	8	GRAY
ESBT-0200	2 AWG	2.00	.42	10	BROWN
ESBT-0100	1 AWG	2.06	.46	11	GREEN
ESBT-1000	1/0 AWG	2.08	.51	12	PINK
ESBT-2000	2/0 AWG	2.17	.56	13	BLACK
ESBT-3000	3/0 AWG	2.30	.62	14	ORANGE
ESBT-4000	4/0 AWG	2.32	.69	15	PURPLE
ESBT-250M	250 MCM	2.46	.75	16	YELLOW
ESBT-300M	300 MCM	2.47	.81	17	WHITE
ESBT-350M	350 MCM	2.60	.88	18	RED
ESBT-400M	400 MCM	2.74	.95	19	BLUE
ESBT-500M	500 MCM	3.15	1.06	20	BROWN
ESBT-600M	600 MCM	3.22	1.18	22	GREEN
ESBT-750M	750 MCM	3.72	1.30	24	BLACK
ESBT-100M	1000 MCM	4.28	1.55	27	WHITE

All wire sizes, unless noted otherwise, are American Wire Gauge (AWG)  
See page 177 (Appendix B) for Flex, DLO and Welding cable conversions.



# COMPRESSION LUGS



## COPPER - ONE HOLE - LONG BARREL



UL Listed 90° C  
Up to 35 kV

- No inspection window is ideal for more corrosive environments as the barrel transition is not open
- Barrel is designed with an internal chamfer at the wire entry to ensure smooth insertion of the wire, preventing possible damaging of the wire strands during insertion
- Long barrel allows for an increased number of crimps which will increase the strength of the connection
- Electro-tin plated unless otherwise specified to reduce galvanic corrosion and resist corrosive elements
- Connectors are clearly marked with stamping and barrel color coding

PART NO	CONDUCTOR SIZE	STUD SIZE	L	W	DIE INDEX	COLOR
ELR1-0814	8 AWG	1/4"	1.26	.44	49	RED
ELR1-0838	8 AWG	3/8"	1.51	.58	49	RED
ELR1-0610	6 AWG	#10	1.27	.41	7	BLUE
ELR1-0614	6 AWG	1/4"	1.45	.45	7	BLUE
ELR1-0638	6 AWG	3/8"	1.62	.63	7	BLUE
ELR1-0612	6 AWG	1/2"	1.87	.75	7	BLUE
ELR1-0414	4 AWG	1/4"	1.74	.50	8	GRAY
ELR1-0438	4 AWG	3/8"	1.92	.58	8	GRAY
ELR1-0412	4 AWG	1/2"	2.20	.71	8	GRAY
ELR1-0214	2 AWG	1/4"	1.88	.61	10	BROWN
ELR1-0256	2 AWG	5/16"	1.93	.61	10	BROWN
ELR1-0238	2 AWG	3/8"	2.06	.61	10	BROWN
ELR1-0212	2 AWG	1/2"	2.32	.73	10	BROWN
ELR1-0156	1 AWG	5/16"	1.94	.68	11	GREEN
ELR1-0138	1 AWG	3/8"	2.06	.68	11	GREEN
ELR1-0112	1 AWG	1/2"	2.37	.73	11	GREEN
ELR1-1056	1/0	5/16"	1.96	.75	12	PINK
ELR1-1038	1/0	3/8"	2.09	.75	12	PINK
ELR1-1012	1/0	1/2"	2.34	.75	12	PINK
ELR1-2038	2/0	3/8"	2.19	.83	13	BLACK
ELR1-2012	2/0	1/2"	2.44	1.02	13	BLACK
ELR1-3038	3/0	3/8"	2.29	.91	14	ORANGE
ELR1-3012	3/0	1/2"	2.54	.91	14	ORANGE
ELR1-4038	4/0	3/8"	2.21	1.02	14	PURPLE
ELR1-4012	4/0	1/2"	2.46	1.02	14	PURPLE
ELR1-25M3	250 MCM	3/8"	2.42	1.11	16	YELLOW
ELR1-25M1	250 MCM	1/2"	2.67	1.11	16	YELLOW

All wire sizes, unless noted otherwise, are American Wire Gauge (AWG)  
See page 177 (Appendix B) for Flex, DLO and Welding cable conversions.

Continued on Next Page...



Visit us on the web at  
[www.posi-tech.com](http://www.posi-tech.com)



# COMPRESSION LUGS

## COPPER - ONE HOLE - LONG BARREL



UL Listed 90° C  
Up to 35 kV



Continued from previous page

PART NO	CONDUCTOR SIZE	STUD SIZE	L	W	DIE INDEX	COLOR
ELR1-30M3	300 MCM	3/8"	2.44	1.20	17	WHITE
ELR1-30M1	300 MCM	1/2"	2.69	1.20	17	WHITE
ELR1-35M3	350 MCM	3/8"	2.50	1.29	18	RED
ELR1-35M1	350 MCM	1/2"	2.75	1.29	18	RED
ELR1-40M1	400 MCM	1/2"	3.12	1.40	19	BLUE
ELR1-40M5	400 MCM	5/8"	3.18	1.40	19	BLUE
ELR1-50M1	500 MCM	1/2"	3.12	1.55	20	BROWN
ELR1-50M5	500 MCM	5/8"	3.37	1.55	20	BROWN
ELR1-60M1	600 MCM	1/2"	3.29	1.74	22	GREEN
ELR1-60M5	600 MCM	5/8"	3.54	1.74	22	GREEN
ELR1-75M1	750 MCM	1/2"	3.41	1.91	24	BLACK
ELR1-75M5	750 MCM	5/8"	3.57	1.91	24	BLACK
ELR1-10M5	1000 MCM	5/8"	4.04	2.19	27	WHITE

All wire sizes, unless noted otherwise, are American Wire Gauge (AWG)  
See page 177 (Appendix B) for Flex, DLO and Welding cable conversions.

## COPPER BUTT SPLICE - LONG BARREL



UL Listed 90° C  
Up to 35 kV



PART NO	CONDUCTOR SIZE	L	OD	DIE	COLOR
ELBT-0800	8 AWG	1.75	.27	49	RED
ELBT-0600	6 AWG	2.38	.29	7	BLUE
ELBT-0400	4 AWG	2.55	.34	8	GRAY
ELBT-0200	2 AWG	2.82	.42	10	BROWN
ELBT-0100	1 AWG	3.07	.46	11	GREEN
ELBT-1000	1/0 AWG	3.06	.51	12	PINK
ELBT-2000	2/0 AWG	3.30	.56	13	BLACK
ELBT-3000	3/0 AWG	3.30	.62	14	ORANGE
ELBT-4000	4/0 AWG	3.57	.69	15	PURPLE
ELBT-250M	250 MCM	3.58	.75	16	YELLOW
ELBT-300M	300 MCM	4.34	.81	17	WHITE
ELBT-350M	350 MCM	4.35	.88	18	RED
ELBT-400M	400 MCM	4.62	.95	19	BLUE
ELBT-500M	500 MCM	4.91	1.06	20	BROWN
ELBT-600M	600 MCM	5.85	1.18	22	GREEN
ELBT-750M	750 MCM	6.38	1.30	24	BLACK
ELBT-100M	1000 MCM	6.95	1.55	27	WHITE

All wire sizes, unless noted otherwise, are American Wire Gauge (AWG)  
See page 177 (Appendix B) for Flex, DLO and Welding cable conversions.





# COMPRESSION LUGS



## COPPER - TWO HOLE - LONG BARREL



UL Listed 90° C  
Up to 35 kV

- No inspection window is ideal for more corrosive environments as the barrel transition is not open
- Electro-tin plated unless otherwise specified to reduce galvanic corrosion (bimetallic) and resist corrosive elements
- Connectors are clearly marked with stamping and barrel color coding

PART NO	CONDUCTOR SIZE	STUD SIZE	SPACING CENTER TO CENTER	L	W	DIE INDEX	COLOR
ELR2-0814	8 AWG	1/4"	5/8"	2.33	.40	49	RED
ELR2-0838	8 AWG	3/8"	1"	2.89	.73	49	RED
ELR2-0614	6 AWG	1/4"	5/8"	2.65	.45	7	BLUE
ELR2-0638	6 AWG	3/8"	1"	3.22	.63	7	BLUE
ELR2-0612	6 AWG	1/2"	1-3/4"	4.40	.81	7	BLUE
ELR2-0414	4 AWG	1/4"	5/8"	2.70	.50	8	GRAY
ELR2-0438	4 AWG	3/8"	1"	3.26	.56	8	GRAY
ELR2-0214	2 AWG	1/4"	5/8"	2.86	.60	10	BROWN
ELR2-0256	2 AWG	5/16"	3/4"	3.05	.60	10	BROWN
ELR2-0238	2 AWG	3/8"	1"	4.17	.60	10	BROWN
ELR2-0212	2 AWG	1/2"	1-3/4"	4.64	.81	10	BROWN
ELR2-0138	1 AWG	3/8"	1"	3.59	.68	11	GREEN
ELR2-0112	1 AWG	1/2"	1-3/4"	4.82	.81	11	GREEN
ELR2-1056	1/0 AWG	5/16"	3/4"	3.49	.75	12	PINK
ELR2-1038	1/0 AWG	3/8"	1"	3.62	.75	12	PINK
ELR2-1012	1/0 AWG	1/2"	1-3/4"	4.81	.81	12	PINK
ELR2-2038	2/0 AWG	3/8"	1"	3.78	.83	13	BLACK
ELR2-2012	2/0 AWG	1/2"	1-3/4"	4.97	.83	13	BLACK
ELR2-3012	3/0 AWG	1/2"	1-3/4"	5.01	.91	14	ORANGE
ELR2-4012	4/0 AWG	1/2"	1-3/4"	5.17	1.02	15	PURPLE
ELR2-25M3	250 MCM	3/8"	1"	4.02	1.10	16	YELLOW
ELR2-25M1	250 MCM	1/2"	1-3/4"	5.21	1.11	16	YELLOW
ELR2-30M3	300 MCM	3/8"	1"	4.45	1.20	17	WHITE
ELR2-30M1	300 MCM	1/2"	1-3/4"	5.64	1.20	17	WHITE
ELR2-35M3	350 MCM	3/8"	1"	4.49	1.29	18	RED
ELR2-35M1	350 MCM	1/2"	1-3/4"	5.68	1.29	18	RED
ELR2-40M1	400 MCM	1/2"	1-3/4"	5.85	1.38	19	BLUE
ELR2-50M1	500 MCM	1/2"	1-3/4"	6.06	1.55	20	BROWN
ELR2-60M1	600 MCM	1/2"	1-3/4"	6.59	1.74	22	GREEN
ELR2-75M1	750 MCM	1/2"	1-3/4"	6.87	1.91	24	BLACK
ELR2-10M1	1000 MCM	1/2"	1-3/4"	7.14	2.17	27	WHITE

All wire sizes, unless noted otherwise, are American Wire Gauge (AWG)  
See page 177 (Appendix B) for Flex, DLO and Welding cable conversions.



# COMPRESSION LUGS



## DUAL RATED ALUMINUM - ONE HOLE



UL Listed 90° C  
Up to 35 kV

PART NO	CONDUCTOR SIZE	STUD SIZE	L	W	DIE INDEX	COLOR
ASR1-0614	6 AWG	1/4"	1.84	.47	346	GRAY
ASR1-0414	4 AWG	1/4"	2.13	.47	375	GREEN
ASR1-0214	2 AWG	1/4"	2.25	.50	348	PINK
ASR1-0256	2 AWG	5/16"	2.50	.88	348	PINK
ASR1-0238	2 AWG	3/8"	2.56	.88	348	PINK
ASR1-0138	1 AWG	3/8"	2.59	.76	471	GOLD
ASR1-1056	1/0	5/16"	2.31	.60	296	TAN
ASR1-1038	1/0	3/8"	2.67	.82	296	TAN
ASR1-1012	1/0	1/2"	2.67	1.03	296	TAN
ASR1-2038	2/0	3/8"	2.79	.67	297	OLIVE
ASR1-2012	2/0	1/2"	3.03	1.03	297	OLIVE
ASR1-3038	3/0	3/8"	2.88	.73	467	RUBY
ASR1-3012	3/0	1/2"	3.27	1.04	467	RUBY
ASR1-4038	4/0	3/8"	3.26	1.17	298	WHITE
ASR1-4012	4/0	1/2"	3.44	1.17	298	WHITE
ASR1-25M1	250 MCM	1/2"	3.53	1.26	324	RED
ASR1-30M1	300 MCM	1/2"	3.90	1.38	470	BLUE
ASR1-35M1	350 MCM	1/2"	4.33	1.52	299	BROWN
ASR1-40M1	400 MCM	1/2"	4.92	1.62	472	GREEN
ASR1-50M1	500 MCM	1/2"	5.56	1.80	300	PINK
ASR1-60M5	600 MCM	5/8"	5.82	1.97	473	BLACK
ASR1-75M5	750 MCM	5/8"	5.80	2.05	936	YELLOW
ASR1-10M5	1000 MCM	5/8"	6.50	2.50	302	BROWN

All wire sizes, unless noted otherwise, are American Wire Gauge (AWG)

## ANTI-OX FOR AL/CU CONNECTIONS



Anti-Ox is a high quality, non-dripping, paste like grease compound designed to prevent air and moisture from creating corrosion and the formation of oxide film in electrical connections. Anti-Ox is used for aluminum to copper and aluminum to aluminum wire connections and improves the conductivity and overall service life of the electrical connection. Anti-Ox is stable over a wide range of temperatures and is non-melting at 500 °F. Anti-Ox has an expected service range of -40 °F to 300 °F.

PART NO	DESCRIPTION	SIZE	CASE
CUAL-0400	ANTI-OX FOR AL/CU CONNECTIONS	40z	12
CUAL-1000	ANTI-OX FOR AL/CU CONNECTIONS	80z	12



# COMPRESSION LUGS



# MECHANICAL ADAPTER PINS



## DUAL RATED ALUMINUM - TWO HOLE



PART NO	CONDUCTOR SIZE	STUD SIZE	SPACING CENTER TO CENTER	L	W	DIE INDEX	COLOR
ASR2-1038	1/0 AWG	3/8"	1"	3.73	.82	296	TAN
ASR2-2012	2/0 AWG	1/2"	1-3/4"	4.78	1.03	297	OLIVE
ASR2-3012	3/0 AWG	1/2"	1-3/4"	5.02	1.04	467	RUBY
ASR2-4012	4/0 AWG	1/2"	1-3/4"	5.19	1.17	298	WHITE
ASR2-25M1	250 MCM	1/2"	1-3/4"	5.28	1.26	324	RED
ASR2-30M1	300 MCM	1/2"	1-3/4"	5.69	1.38	470	BLUE
ASR2-35M1	350 MCM	1/2"	1-3/4"	6.07	1.52	299	BROWN
ASR2-40M1	400 MCM	1/2"	1-3/4"	4.93	1.62	472	GREEN
ASR2-50M1	500 MCM	1/2"	1-3/4"	6.80	1.62	300	PINK
ASR2-60M1	600 MCM	1/2"	1-3/4"	7.09	1.62	473	BLACK
ASR2-75M1	750 MCM	1/2"	1-3/4"	7.07	2.05	936	YELLOW
ASR2-10M1	1000 MCM	1/2"	1-3/4"	7.76	1.65	302	BROWN



UL Listed 90° C  
Up to 35 kV

All wire sizes, unless noted otherwise, are American Wire Gauge (AWG)

## DUAL RATED ALUMINUM SPLICE



UL Listed 90° C  
Up to 35 kV

PART NO	CONDUCTOR SIZE	L	DIE INDEX	COLOR
ASBT-0600	6 AWG	1.70	346	GRAY
ASBT-0400	4 AWG	1.97	375	GREEN
ASBT-0200	2 AWG	2.44	348	PINK
ASBT-0100	1 AWG	2.05	471	GOLD
ASBT-1000	1/0 AWG	2.37	296	TAN
ASBT-2000	2/0 AWG	2.61	297	OLIVE
ASBT-3000	3/0 AWG	2.8	467	RUBY
ASBT-4000	4/0 AWG	3.06	298	WHITE
ASBT-250M	250 MCM	3.18	324	RED
ASBT-300M	300 MCM	3.20	470	BLUE
ASBT-350M	350 MCM	4.04	299	BROWN
ASBT-400M	400 MCM	4.86	472	GREEN
ASBT-500M	500 MCM	5.00	300	PINK
ASBT-600M	600 MCM	5.14	473	BLACK
ASBT-750M	750 MCM	5.26	936	YELLOW
ASBT-100M	1000 MCM	5.94	302	BROWN

All wire sizes, unless noted otherwise, are American Wire Gauge (AWG)

## STRAIGHT - DUAL RATED ALUMINUM



UL Listed 90° C  
Up to 35 kV

- Manufactured from high strength aluminum alloy
- Pin is knurled
- Chamfered barrel
- UL Listed for 600 volts, 90° C
- Clearly marked with wire size and die index
- Prefilled with DE-OX
- Color coded end caps inserted in barrel
- Supplied with insulating cover

PART NO	CONDUCTOR SIZE	PIN DIA	PIN SIZE	PIN LENGTH	OD	DIE INDEX	COLOR
ASPN-0600	6 AWG	.22	#4 AWG	.68	.61	8	TAN
ASPN-0400	4 AWG	.24	#4 AWG	.68	.61	8	TAN
ASPN-0200	2 AWG	.24	#4 AWG	.68	.61	8	TAN
ASPN-0100	1 AWG	.26	#3 AWG	.84	.61	8	TAN
ASPN-1000	1/0 AWG	.29	#2 AWG	.84	.86	12	WHITE
ASPN-2000	2/0 AWG	.33	#1 AWG	.84	.86	12	WHITE
ASPN-3000	3/0 AWG	.37	1/0 AWG	1.22	.86	12	WHITE
ASPN-4000	4/0 AWG	.42	2/0 AWG	1.22	.86	12	WHITE
ASPN-250M	250 MCM	.47	3/0 AWG	1.22	1.11	14	BROWN
ASPN-300M	300 MCM	.53	4/0 AWG	1.34	1.11	14	BROWN
ASPN-350M	350 MCM	.57	250 MCM	1.34	1.11	14	BROWN
ASPN-400M	400 MCM	.63	300 MCM	1.60	1.33	16A	PINK
ASPN-500M	500 MCM	.68	350 MCM	1.60	1.33	16A	PINK
ASPN-600M	600 MCM	.73	400 MCM	1.64	1.49	18	YELLOW
ASPN-750M	750 MCM	.81	500 MCM	1.76	1.49	18	YELLOW

All wire sizes, unless noted otherwise, are American Wire Gauge (AWG)

## OFFSET - DUAL RATED ALUMINUM



UL Listed 90° C  
Up to 35 kV

PART NO	CONDUCTOR SIZE	PIN DIA	PIN SIZE	PIN LENGTH	OD	DIE INDEX	COLOR
ASPO-2000	2/0 AWG	.33	#1 AWG	.84	.86	12	WHITE
ASPO-3000	3/0 AWG	.37	1/0 AWG	1.22	.86	12	WHITE
ASPO-4000	4/0 AWG	.42	2/0 AWG	1.22	.86	12	WHITE
ASPO-250M	250 MCM	.47	3/0 AWG	1.22	1.11	14	BROWN
ASPO-300M	300 MCM	.53	4/0 AWG	1.22	1.11	14	BROWN
ASPO-350M	350 MCM	.57	250 MCM	1.34	1.11	14	BROWN
ASPO-500M	500 MCM	.68	350 MCM	1.60	1.33	16A	PINK
ASPO-600M	600 MCM	.73	400 MCM	1.64	1.49	18	YELLOW
ASPO-750M	750 MCM	.90	500 MCM	1.76	1.49	18	YELLOW

All wire sizes, unless noted otherwise, are American Wire Gauge (AWG)





# ECONOMY LUGS

## COPPER TIN PLATED RING



600V

- Manufactured from high strength seamless copper tubing
- Electro-Tin plated
- Maximum conductivity and excellent crimping characteristics
- Suggested for applications of 600 Volts or less 90° C
- Ease of wire insertion with flared end
- For Copper Conductor only

PART NO	CONDUCTOR SIZE	STUD SIZE	L	TANG WIDTH
HVRG-0810	8 AWG	#10	1.15	.47
HVRG-0814	8 AWG	1/4"	1.15	.47
HVRG-0856	8 AWG	5/16"	1.15	.47
HVRG-0838	8 AWG	3/8"	1.15	.47
HVRG-0610	6 AWG	#10	1.32	.47
HVRG-0614	6 AWG	1/4"	1.32	.53
HVRG-0656	6 AWG	5/16"	1.32	.53
HVRG-0638	6 AWG	3/8"	1.32	.54
HVRG-0612	6 AWG	1/2"	1.32	.67
HVRG-0410	4 AWG	#10	1.38	.55
HVRG-0414	4 AWG	1/4"	1.38	.55
HVRG-0456	4 AWG	5/16"	1.38	.55
HVRG-0438	4 AWG	3/8"	1.38	.58
HVRG-0412	4 AWG	1/2"	1.38	.67
HVRG-0214	2 AWG	1/4"	1.62	.62
HVRG-0256	2 AWG	5/16"	1.62	.62
HVRG-0238	2 AWG	3/8"	1.62	.62
HVRG-0212	2 AWG	1/2"	1.62	.75
HVRG-0114	1 AWG	1/4"	1.58	.62
HVRG-0156	1 AWG	5/16"	1.58	.62
HVRG-0138	1 AWG	3/8"	1.58	.62
HVRG-0112	1 AWG	1/2"	1.58	.75
HVRG-1014	1/0 AWG	1/4"	1.83	.73
HVRG-1056	1/0 AWG	5/16"	1.83	.73
HVRG-1038	1/0 AWG	3/8"	1.83	.73
HVRG-1012	1/0 AWG	1/2"	1.83	.73
HVRG-2014	2/0 AWG	1/4"	2.00	.73
HVRG-2056	2/0 AWG	5/16"	2.00	.73
HVRG-2038	2/0 AWG	3/8"	2.00	.73
HVRG-2012	2/0 AWG	1/2"	2.00	.73

All wire sizes, unless noted otherwise, are American Wire Gauge (AWG)

Continued on Next Page...



# ECONOMY LUGS

## COPPER TIN PLATED RING



600V

Continued from previous page

PART NO	CONDUCTOR SIZE	STUD SIZE	L	TANG WIDTH
HVRG-3014	3/0 AWG	1/4"	2.16	.89
HVRG-3056	3/0 AWG	5/16"	2.16	.89
HVRG-3038	3/0 AWG	3/8"	2.16	.89
HVRG-3012	3/0 AWG	1/2"	2.16	.89
HVRG-4014	4/0 AWG	1/4"	2.39	1.05
HVRG-4056	4/0 AWG	5/16"	2.39	1.04
HVRG-4038	4/0 AWG	3/8"	2.39	1.04
HVRG-4012	4/0 AWG	1/2"	2.39	1.04

All wire sizes, unless noted otherwise, are American Wire Gauge (AWG)

## COPPER TIN PLATED SPLICES



600V

- Manufactured from high strength seamless copper tubing
- Electro-Tin plated
- Maximum conductivity and excellent crimping characteristics
- Suggested for applications of 600 Volts or less 90° C
- Ease of wire insertion with flared end
- For Copper Conductor only

PART NO	CONDUCTOR SIZE	L	OD
HVBT-0800	8 AWG	1.00	.29
HVBT-0600	6 AWG	1.06	.31
HVBT-0400	4 AWG	1.20	.37
HVBT-0200	2 AWG	1.35	.43
HVBT-0100	1 AWG	1.35	.46
HVBT-1000	1/0 AWG	1.55	.52
HVBT-2000	2/0 AWG	1.80	.57
HVBT-3000	3/0 AWG	1.90	.63
HVBT-4000	4/0 AWG	2.00	.69

All wire sizes, unless noted otherwise, are American Wire Gauge (AWG)





# INSTALLATION TOOLS

## COMPRESSION TOOLING

- Black oxide crimp ram won't chip or flake
- Dieless design adjusts quickly to sizes 8 awg though 4/0
- For use with most compression barrel lugs



PART NO	CRIMP RANGE	DESCRIPTION
TLCR-4004	#8 - 4/0 COPPER	INDENT CRIMP DIELESS - IMPORT

- Black oxide crimp ram won't chip or flake.
- Dieless design adjusts quickly to sizes 8 awg though 400mcm
- For use with most compression barrel lugs
- Telescoping handles provides for enhanced leverage
- Amazing range from #10 - 400 MCM



PART NO	CRIMP RANGE	DESCRIPTION
TLCR-400M	#10 - 400 MCM COPPER	INDENT CRIMP DIELESS - USA

## CABLE CUTTERS



PART NO	MAX OD	DESCRIPTION
TLCC-0910	2/0	SINGLE HAND CUTTER
TLCC-3015	350 MCM	TWO HANDED CRIMPER 16" HANDLES
TLCC-1124	500 MCM	TWO HANDED CRIMPER 21" HANDLES
TLCC-7015	750 MCM	TWO HANDED RATCHET DRIVE CRIMPER
TLCC-1132	1000 MCM	TWO HANDED CRIMPER 32" HANDLES

## ECONOMY HAMMER CRIMPERS



PART NO	CONDUCTOR SIZE
TLCR-4000	#8 - 4/0 COPPER
TLCR-4001	#8 - 4/0 COPPER



# MECHANICAL LUGS



## SINGLE (1) BARREL



- Manufactured from high strength 6061-T6 aluminum alloy
- Dual Rated for copper or aluminum conductors
- Chamfered wire entry provides ease of installation
- UL Listed for 600 volts, 90° C

PART NO	CONDUCTOR SIZE	STUD SIZE	L	W	H
MCS1-0623	#6 - #14 AWG	1/4"	1.06	.50	.50
MCS1-0225	#2 - #14 AWG	1/4"	1.16	.50	.55
MCS1-1025	1/0 - #14 AWG	1/4"	1.47	.63	.78
MCS1-2025	2/0 - #14 AWG	1/4"	1.47	.63	.78
MCS1-25M31	250 - #6 AWG	5/16"	2.00	.88	1.02
MCS1-35M38	350 - #6 AWG	3/8"	2.25	.99	1.13
MCS1-50M38	500 - #4 AWG	3/8"	2.75	1.20	1.41
MCS1-60M38	600 - #2 AWG	3/8"	3.18	1.38	1.51
MCS1-80M63	800 - 300 MCM	5/8"	3.25	1.44	1.69
MCS1-100M63	1000 - 350 MCM	5/8"	3.25	1.69	1.88

All wire sizes, unless noted otherwise, are American Wire Gauge (AWG)



## SINGLE (1) BARREL, TWO (2) STUD

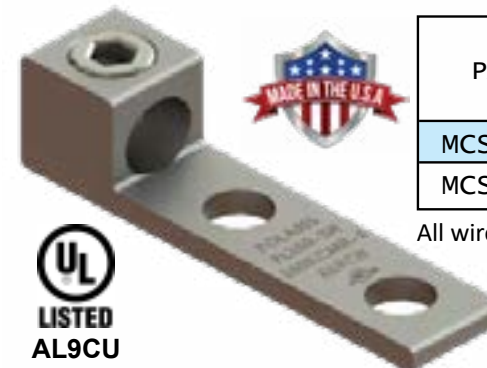

PART NO	CONDUCTOR SIZE	STUD SIZE	SPACING CENTER TO CENTER	L	W	H
MCS2-35M50	350 - #6 AWG	1/2"	1-3/4"	4.25	.99	1.13
MCS2-60M50	600 - #2 AWG	1/2"	1-3/4"	4.65	1.38	1.51

All wire sizes, unless noted otherwise, are American Wire Gauge (AWG)



## SINGLE (1) BARREL, TWO (2) STUD, TWO (2) SET-SCREWS



PART NO	CONDUCTOR SIZE	STUD SIZE	SPACING CENTER TO CENTER	L	W	H
MCS2-60M50D	600 - #2 AWG	1/2"	1-3/4"	5.50	1.38	1.51
MCS2-80M50D	800 - 300 MCM	1/2"	1-3/4"	5.75	1.44	1.69
MCS2-100M50D	1000 - 300 MCM	1/2"	1-3/4"	6.19	1.69	1.88

All wire sizes, unless noted otherwise, are American Wire Gauge (AWG)



Visit us on the web at [www.posi-tech.com](http://www.posi-tech.com)







# MECHANICAL LUGS

## TWO (2) BARREL, DUAL RATED ALUMINUM

- Manufactured from high strength 6061-T6 aluminum alloy
- Dual Rated for copper or aluminum conductors
- Chamfered wire entry provides ease of installation
- UL Listed for 600 volts, 90° C



PART NO	CONDUCTOR SIZE	STUD SIZE	L	W	H
MCD1-1025	1/0 - #14 AWG	1/4"	1.47	.78	1.13
MCD1-2025	2/0 - #14 AWG	1/4"	1.47	.78	1.25
MCD1-25M38	250 MCM - #6 AWG	3/8"	2.56	1.02	1.62
MCD1-35M50	350 MCM - #6 AWG	3/8"	2.88	1.13	1.92
MCD1-60M50	600 MCM - #2 AWG	1/2"	3.18	1.51	2.41
MCD1-80M63	800 MCM - 300 MCM	5/8"	3.25	1.69	2.75
MCD1-100M63	1000 MCM - 350 MCM	5/8"	3.25	1.88	3.19

All wire sizes, unless noted otherwise, are American Wire Gauge (AWG)

## TWO (2) BARREL, TWO (2) STUD



PART NO	CONDUCTOR SIZE	STUD SPACING	STUD SIZE	L	W	H
MCD2-35M50	350 MCM - #6 AWG	1-3/4"	1/2"	4.25	1.92	1.13
MCD2-60M50	600 MCM - #2 AWG	1-3/4"	1/2"	4.65	2.41	1.51

All wire sizes, unless noted otherwise, are American Wire Gauge (AWG)

## TWO (2) BARREL, TWO (2) STUD, TWO (2) SET-SCREWS

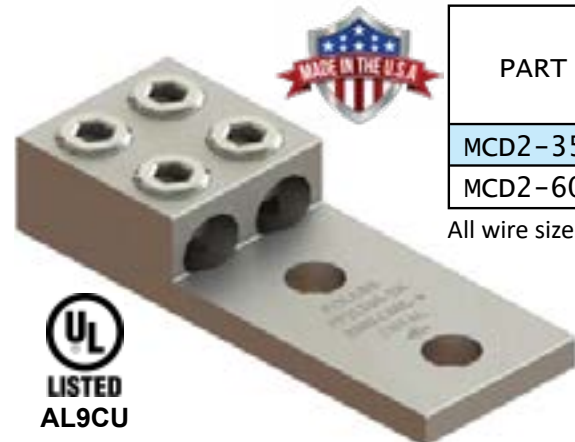

PART NO	CONDUCTOR SIZE	STUD SPACING	STUD SIZE	L	W	H
MCD2-35M50D	350 MCM - #6 AWG	1-3/4"	1/2"	5.25	1.92	1.13
MCD2-60M50D	600 MCM - #2 AWG	1-3/4"	1/2"	5.50	2.41	1.51

All wire sizes, unless noted otherwise, are American Wire Gauge (AWG)



# MECHANICAL LUGS

## THREE (3) BARREL, TWO (2) STUD

- Manufactured from high strength 6061-T6 aluminum alloy
- Dual Rated for copper or aluminum conductors
- Chamfered wire entry provides ease of installation
- UL Listed for 600 volts, 90° C



PART NO	CONDUCTOR SIZE	STUD SIZE	STUD SPACING	L	W	H
MCT4-1038	1/0 - #4 AWG	3/8"	1-3/4"	2.91	2.00	.88
MCT4-3038	3/0 - #6 AWG	3/8"	1-3/4"	4.25	2.81	1.19
MCT4-25M50	250 MCM - #6 AWG	1/2"	1-3/4"	4.25	3.00	1.19
MCT4-35M50	350 MCM - #6 AWG	1/2"	1-3/4"	4.50	3.50	1.38
MCT4-60M50	600 MCM - #2 AWG	1/2"	1-3/4"	4.69	3.75	1.56

All wire sizes, unless noted otherwise, are American Wire Gauge (AWG)

## THREE (3) BARREL, TWO (2) STUD, TWO (2) SET-SCREWS



PART NO	CONDUCTOR SIZE	STUD SIZE	STUD SPACING	L	W	H
MCT4-25M50D	250 MCM - #6 AWG	1/2"	1-3/4"	4.25	3.00	1.19
MCT4-35M50D	350 MCM - #6 AWG	1/2"	1-3/4"	4.50	3.50	1.38
MCT4-60M50D	600 MCM - #2 AWG	1/2"	1-3/4"	4.69	3.75	1.56

All wire sizes, unless noted otherwise, are American Wire Gauge (AWG)

## TURN PREVENT LUGS

- Features Anti-Rotational Tang
- Manufactured from high strength 6061-T6 aluminum alloy
- Dual Rated for copper or aluminum conductors
- Chamfered wire entry provides ease of installation
- UL Listed for 600 volts, 90° C



PART NO	CONDUCTOR SIZE	STUD SIZE	L	W	H
MCAT-2025	2/0 - #14 AWG	1/4"	1.47	.63	.78
MCAT-30M25	300 MCM - #6 AWG	1/4"	2.00	.88	1.13
MCAT-35M31	350 MCM - #6 AWG	5/16"	2.25	1.13	1.25
MCAT-60M38	600 MCM - #2 AWG	1/2"	3.13	1.50	1.56
MCDT-60M50	DOUBLE (2) BARREL 600 MCM - #2 AWG	1/2"	3.13	2.41	1.56

All wire sizes, unless noted otherwise, are American Wire Gauge (AWG)



# MECHANICAL LUGS

## FOUR (4) BARREL, FOUR (4) STUD



- Manufactured from high strength 6061-T6 aluminum alloy
- Dual Rated for copper or aluminum conductors
- Chamfered wire entry provides ease of installation
- UL Listed for 600 volts, 90° C

PART NO	CONDUCTOR SIZE	STUD SIZE	STUD SPACING	L	W	H
MCF4-60M50	600 MCM - #2 AWG	1/2"	1-3/4"	4.65	5.00	1.50
MCF4-80M50	800 - 300 MCM	1/2"	1-3/4"	4.75	5.38	1.69
MCF4-10050	1000 - 350 MCM	1/2"	1-3/4"	4.94	6.19	1.88

All wire sizes, unless noted otherwise, are American Wire Gauge (AWG)



## FOUR (4) BARREL, FOUR (4) STUD - TWO (2) SET-SCREWS



PART NO	CONDUCTOR SIZE	STUD SIZE	STUD SPACING	L	W	H
MCF4-60M50D	600 MCM - #2 AWG	1/2"	1-3/4"	5.50	5.00	1.51
MCF4-80M50D	800 - 300 MCM	1/2"	1-3/4"	5.75	5.38	1.69
MCF4-10050D	1000 - 350 MCM	1/2"	1-3/4"	6.19	6.19	1.88

All wire sizes, unless noted otherwise, are American Wire Gauge (AWG)



## DUAL RANGE LUGS



- Features Anti-Rotational Tang
- Manufactured from high strength 6061-T6 aluminum alloy
- Dual Rated for copper or aluminum conductors
- Chamfered wire entry provides ease of installation
- UL Listed for 600 volts, 90° C

PART NO	CONDUCTOR SIZE	STUD SIZE	L	W	H
MCDR-60M38	600 MCM - 4 AWG OR (2) 250 MCM - 1/0	3/8"	2.81	1.38	1.81
MCDR-75M38	750 MCM - 10 AWG OR (2) 250 MCM - 1/0	3/8"	2.81	1.38	1.81

All wire sizes, unless noted otherwise, are American Wire Gauge (AWG)



# MECHANICAL LUGS

## PANELBOARD LUGS

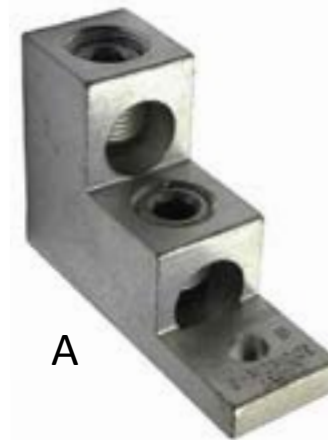

A



B

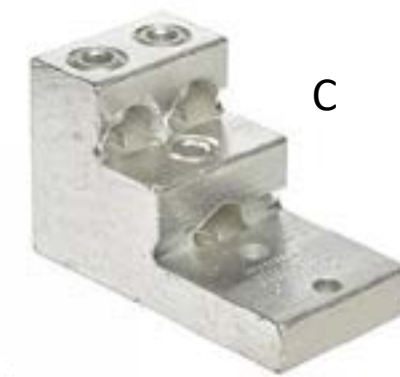

C



D



PART NO	FIGURE	CONDUCTOR SIZE	STUD SPACING	STUD SIZE	L	W	H
MCD1-30M31S	A	300 MCM - #6 AWG	NA	5/16"	3.00	1.00	2.00
MCD2-60M38S	B	600 MCM - #2 AWG	1-3/8"	3/8"	5.06	1.50	2.90
MCD2-75M38S	B	750 MCM - 1/0 AWG	1-3/8"	3/8"	5.06	1.50	2.90
MCT2-60M38S	C	600 MCM - #2 AWG	1-3/8"	3/8"	5.06	2.47	2.90
MCT2-75M38S	C	750 MCM - 1/0 AWG	1-3/8"	3/8"	5.06	2.47	2.90
MCF2-60M38S	D	600 MCM - #2 AWG	1-3/8"	3/8"	5.06	2.90	2.90
MCF2-75M38S	D	750 MCM - 1/0 AWG	1-3/8"	3/8"	5.06	2.90	2.90

All wire sizes, unless noted otherwise, are American Wire Gauge (AWG)

## SPLICE CONNECTORS



A



B

PART NO	FIGURE	CONDUCTOR SIZE	L	W	H
MCBT-0200	A	#2 - #14 AWG	1.59	.55	.55
MCBT-1000	A	1/0 - #14 AWG	1.91	.56	.70
MCBT-250MD	B	250 MCM - #6 AWG	4.09	.81	1.00
MCBT-350M	A	350 MCM - #10 AWG	4.34	1.00	1.13
MCBT-500MD	B	500 MCM - 3/0 AWG	4.78	1.25	1.38

All wire sizes, unless noted otherwise, are American Wire Gauge (AWG)







# MECHANICAL LUGS

## LAY-IN DUAL RATED ALUMINUM



- Manufactured from high strength 6061-T6 aluminum alloy.
- Electro-tin plated.
- UL 467 Listed for grounding and bonding.
- UL2703 Listed
- Lay-in feature.
- Suitable for use with either copper or aluminum.
- Provides low contact resistance.

PART NO	CONDUCTOR SIZE	STUD SIZE	L	W	H
MCLA-0421	#4 AWG - #14 AWG	#10	1.07	.38	.75
MCLA-1027	1/0 - #8 AWG	1/4"	1.50	.60	1.10
MCLA-3033	3/0 - #6 AWG	5/16"	2.00	.80	1.50
MCLA-25M33	250 MCM - #6 AWG	5/16"	2.20	.80	1.70

All wire sizes, unless noted otherwise, are American Wire Gauge (AWG)

## LAY-IN COPPER GROUNDING LUG



Copper Only



PART NO	CONDUCTOR SIZE	STUD SIZE	L	W	H
MCLA-0421-DB	#4 AWG - #14 AWG	#10	1.07	.38	.75

All wire sizes, unless noted otherwise, are American Wire Gauge (AWG)

## TRANSFORMER LUG KITS



- Manufactured from high strength 6061-T6 aluminum alloy.
- Electro-tin plated.
- Kit includes all required hardware

PART NO	TRANSFORMER KVA SIZE	CONTENTS (INCLUDES LOCKING HEX NUTS)
TLK-1000	15-37-1/2 1Ø 15-45 3Ø	(8) #2-#14 LUG (4) 250-#6 LUG (8) 1/4-20 X 3/4" HWH
TLK-2000	50-75 1Ø 75-112-1/2 3Ø	(12) 250-#6 LUG (8) 1/4-20 X 3/4" HWH (8) 1/4-20 X 2" HWH
TLK-3000	100-167 1Ø 150-300 3Ø	(3) 250-#6 LUG (3) 600-#4 LUG (3) 1/4-20 X 3/4" HWH (16) 3/8-16 X 2" HWH
TLK-4000	500 3Ø	(29) 600-#4 LUG (18) 3/8-16 X 2" HWH

All wire sizes, unless noted otherwise, are American Wire Gauge (AWG)



# CU MECHANICAL LUGS

## OFFSET MECHANICAL



- Manufactured from electrolytic copper tubing and strip stock
- Compact design
- Re-Usable
- UL 486A/B Listed
- For Copper Conductor only

PART NO	CONDUCTOR SIZE	STUD SIZE	L	W	H
MCCU-0025	#10 - #14 AWG	#6	1.00	.31	.65
MCCU-0035	#6 - #14 AWG	#10	1.19	.38	.75
MCCU-0070	#4 - #14 AWG	1/4"	1.53	.50	.81
MCCU-0125	1/0 - #6 AWG	1/4"	1.97	.63	1.34
MCCU-0175	3/0 - #4 AWG	3/8"	2.19	.75	1.56
MCCU-0225	4/0 - #2 AWG	5/16"	2.63	1.00	1.81
MCCU-0300	350 MCM - 1/0 AWG	3/8"	3.19	1.00	2.63
MCCU-0400	500 MCM - 1/0 AWG	3/8"	4.25	2.00	2.75

All wire sizes, unless noted otherwise, are American Wire Gauge (AWG)

## STRAIGHT MECHANICAL



PART NO	CONDUCTOR SIZE	STUD SIZE	L	W	H
MCCF-0025	#10 - #14 AWG	#6	.95	.31	.59
MCCF-0035	#6 - #14 AWG	#10	1.14	.38	.69
MCCF-0070	#4 - #14 AWG	1/4"	1.25	.50	.97
MCCF-0125	1/0 - #6 AWG	1/4"	1.94	.63	1.25
MCCF-0175	3/0 - #4 AWG	3/8"	2.19	.75	1.56
MCCF-0225	4/0 - #2 AWG	5/16"	2.38	1.00	1.66
MCCF-0300	350 MCM - 1/0 AWG	3/8"	3.19	1.00	2.38
MCCF-0400	500 MCM - 1/0 AWG	3/8"	3.88	1.50	2.56

All wire sizes, unless noted otherwise, are American Wire Gauge (AWG)

## FORGED POST CONNECTOR



PART NO	CONDUCTOR SIZE	STUD SIZE	L	W	H
MCC1-0810	#8 - #14 AWG	#10	.818	.40	.45
MCC1-0414	#4 - #14 AWG	1/4"	1.09	.54	.59
MCC1-1056	1/0 - #14 AWG	5/16"	1.50	.73	.76
MCC1-25M3	250 MCM - #6 AWG	3/8"	1.97	.94	1.06

All wire sizes, unless noted otherwise, are American Wire Gauge (AWG)



# INSULATED TAPS

## 2 PORT SINGLE SIDE ENTRY



- UL Listed for 600 volts, 90°C
- Dual rated for copper or aluminum conductor
- Cold temperature rated to -45°C
- High dielectric strength plastisol is chemical resistant
- Black cover is UV rated
- Removable port & screw plugs
- Prefilled with De-ox

PART NO	WIRE RANGE	L	W	H
CLTS-0402	#4 - #14 AWG	1.24	1.22	1.42
CLTS-0403	#4 - #14 AWG	1.70	1.22	1.42
CLTS-0404	#4 - #14 AWG	2.16	1.22	1.42
CLTS-1002	1/0 - #14 AWG	1.67	1.53	1.63
CLTS-1003	1/0 - #14 AWG	2.29	1.53	1.63
CLTS-1004	1/0 - #14 AWG	2.92	1.53	1.63
CLTS-3002	3/0 - #6 AWG	1.89	1.58	1.86
CLTS-3003	3/0 - #6 AWG	2.65	1.58	1.86
CLTS-3004	3/0 - #6 AWG	3.42	1.58	1.86
CLTS-25M2	250 MCM - #6 AWG	2.17	1.91	2.17
CLTS-25M3	250 MCM - #6 AWG	3.07	1.91	2.17
CLTS-25M4	250 MCM - #6 AWG	3.96	1.91	2.62
CLTS-35M2	350 MCM - #6 AWG	2.51	2.03	2.62
CLTS-35M3	350 MCM - #6 AWG	2.51	2.03	2.62
CLTS-35M4	350 MCM - #6 AWG	4.61	2.03	2.62
CLTS-60M2	600 MCM - #4 AWG	2.97	2.28	3.04
CLTS-60M3	600 MCM - #4 AWG	4.12	2.28	3.04
CLTS-60M4	600 MCM - #4 AWG	5.28	2.28	3.04

All wire sizes, unless noted otherwise, are American Wire Gauge (AWG)

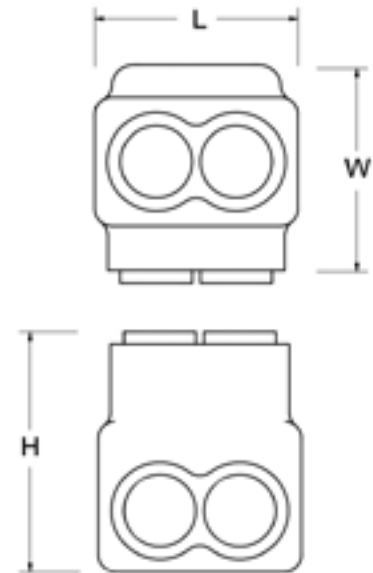

## 2 PORT OFFSET ENTRY



PART NO	WIRE RANGE	L	W	H
CLTO-1002	1/0 - #14 AWG	1.63	1.62	1.63
CLTO-3002	3/0 - #6 AWG	1.89	1.73	1.86

All wire sizes, unless noted otherwise, are American Wire Gauge (AWG)



Visit us on the web at [www.posi-tech.com](http://www.posi-tech.com)



# INSULATED TAPS

## TWO CONDUCTOR DUAL SIDED



- Broad wire range: 750kcmil-14
- UL Listed for 600 volts, 90°C
- Dual rated for copper or aluminum conductor
- Cold temperature rated to -45°C
- High dielectric strength plastisol is chemical resistant
- Black cover is UV rated
- Removable port & screw plugs
- Prefilled with De-ox

PART NO	WIRE RANGE	L	W	H
CLTD-0402	#4 - #14 AWG	1.17	1.17	1.38
CLTD-1002	1/0 - #14 AWG	1.62	1.62	1.63
CLTD-3002	3/0 - #6 AWG	1.89	1.73	1.86
CLTD-25M2	250 MCM - #6 AWG	2.09	1.94	2.04
CLTD-35M2	350 MCM - #6 AWG	2.53	2.41	2.62
CLTD-60M2	600 MCM - #4 AWG	2.78	2.48	3.03
CLTD-75M2	750 MCM - 250 MCM	3.34	2.89	3.21

All wire sizes, unless noted otherwise, are American Wire Gauge (AWG)

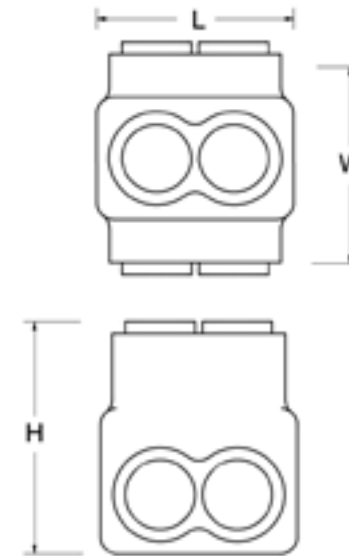

## BUTT SPLICE



PART NO	WIRE RANGE	L	W	H
CLTB-1000	1/0 - #14 AWG	3.45	.94	1.63
CLTB-250M	250 MCM - #6 AWG	3.88	1.19	2.04
CLTB-350M	350 MCM - #6 AWG	4.75	1.31	2.43
CLTB-500M	500 MCM - #4 AWG	5.78	1.38	3.00
CLTB-750M	750 MCM - 250 MCM	7.25	1.75	3.46

All wire sizes, unless noted otherwise, are American Wire Gauge (AWG)

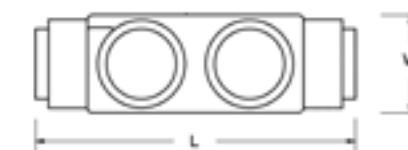





# INSULATED MULTI-TAPS

## MULTI CONDUCTOR DUAL SIDED

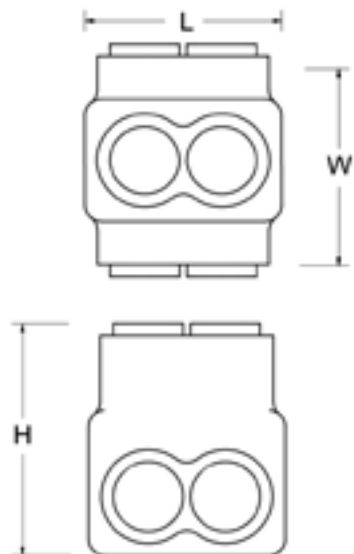

- Broad wire range: 750kcmil-14
- UL Listed for 600 volts, 90°C
- Dual rated for copper or aluminum conductor
- Cold temperature rated to -45°C
- Black cover is UV rated and chemical resistant
- Removable port & screw plugs
- Prefilled with Anti-Ox

PART NO	WIRE RANGE	PORTS	L	W	H
CLTD-0403	#4 - #14 AWG	3	1.70	1.39	1.42
CLTD-0404	#4 - #14 AWG	4	2.16	1.39	1.42
CLTD-1003	1/0 - #14 AWG	3	2.25	1.83	1.83
CLTD-1004	1/0 - #14 AWG	4	2.87	1.83	1.83
CLTD-1006	1/0 - #14 AWG	6	4.17	1.83	1.83
CLTD-3003	3/0 - #6 AWG	3	2.65	2.28	2.02
CLTD-3004	3/0 - #6 AWG	4	3.42	2.28	2.02
CLTD-3006	3/0 - #6 AWG	6	4.95	2.28	2.02
CLTD-25M3	250 MCM - #6 AWG	3	3.04	2.32	2.04
CLTD-25M4	250 MCM - #6 AWG	4	3.97	2.32	2.04
CLTD-25M6	250 MCM - #6 AWG	6	5.83	2.32	2.04
CLTD-25M8	250 MCM - #6 AWG	8	7.69	2.32	2.04
CLTD-25M10	250 MCM - #6 AWG	10	9.55	2.32	2.04
CLTD-35M3	350 MCM - #6 AWG	3	3.62	2.58	2.40
CLTD-35M4	350 MCM - #6 AWG	4	4.78	2.58	2.40
CLTD-35M6	350 MCM - #6 AWG	6	7.09	2.58	2.40
CLTD-35M8	350 MCM - #6 AWG	8	9.40	2.58	2.40
CLTD-35M10	350 MCM - #6 AWG	10	11.72	2.58	2.40
CLTD-60M3	600 MCM - #4 AWG	3	4.06	3.03	3.03
CLTD-60M4	600 MCM - #4 AWG	4	5.34	.03	3.03
CLTD-60M6	600 MCM - #4 AWG	6	7.91	3.03	3.03
CLTD-60M8	600 MCM - #4 AWG	8	10.47	3.03	3.03
CLTD-60M10	600 MCM - #4 AWG	10	13.03	3.03	3.03
CLTD-60M12	600 MCM - #4 AWG	12	15.59	3.03	3.03
CLTD-75M3	750 MCM - 250 MCM	3	4.90	3.41	3.21
CLTD-75M4	750 MCM - 250 MCM	4	6.46	3.41	3.21
CLTD-75M6	750 MCM - 250 MCM	6	9.58	3.41	3.21
CLTD-75M8	750 MCM - 250 MCM	8	12.70	3.41	3.21
CLTD-75M10	750 MCM - 250 MCM	10	15.82	3.41	3.21
CLTD-75M12	750 MCM - 250 MCM	12	18.94	3.41	3.21

All wire sizes, unless noted otherwise, are American Wire Gauge (AWG)



# INSULATED MULTI-TAPS

## DIRECT BURIAL SECONDARY CONNECTORS

- Encapsulated in EPDM rubber with a nominal thickness of 125 Mills and a dielectric strength of 240 Volts per Mil
- Pre-marked end insert allows broad wire range
- O-Ring design screw cap inserts
- Connector is produced from high strength 6061-T6 aluminum alloy
- For proper installation torques, refer to the stuffer sheet or the recommended torque column below
- Rated for 600 Volts, 90° C
- Dual Rated for Copper and Aluminum Conductor
- UL Listed for Direct Burial
- Connector has solid wire stop
- Tested to UL 486D



PART NO	WIRE RANGE	PORTS	L	W	H
CLTS-35M3-DB	350 MCM - #12 AWG	3	3.67	4.40	2.70
CLTS-35M4-DB	350 MCM - #12 AWG	4	4.82	4.40	2.70
CLTS-35M5-DB	350 MCM - #12 AWG	5	6.04	4.40	2.70
CLTS-35M6-DB	350 MCM - #12 AWG	6	7.14	4.40	2.70
CLTS-35M8-DB	350 MCM - #12 AWG	8	9.45	4.40	2.70

All wire sizes, unless noted otherwise, are American Wire Gauge (AWG)

PART NO	WIRE RANGE	PORTS	L	W	H
CLTS-50M3-DB	500 MCM - #10 AWG	3	4.57	5.06	2.82
CLTS-50M4-DB	500 MCM - #10 AWG	4	6.04	5.06	2.82
CLTS-50M5-DB	500 MCM - #10 AWG	5	7.50	5.06	2.82
CLTS-50M6-DB	500 MCM - #10 AWG	6	8.98	5.06	2.82
CLTS-50M8-DB	500 MCM - #10 AWG	8	11.92	5.06	2.82

All wire sizes, unless noted otherwise, are American Wire Gauge (AWG)

## DIRECT BURIAL SPLICE FOR SECONDARY CONNECTORS



PART NO	WIRE RANGE	L	W	H
CLTB-350M-DB	350 MCM - #10 AWG	7.00	1.25	2.89
CLTB-500M-DB	500 MCM - #10 AWG	9.81	1.89	3.84

All wire sizes, unless noted otherwise, are American Wire Gauge (AWG)

Visit us on the web at [www.posi-tech.com](http://www.posi-tech.com)





# POWER TAPS

## INSULATION PIERCING

### Features

- Body is molded from tough, resilient glass-filled nylon
- Compact design
- Tin plated copper contact teeth
- Insulation piercing
- Perforated end tabs
- Pre-filled with silicone lubricant
- Increased safety
- Horizontal line grid
- Temperature rating 90° C

### Benefits

- Provides high degree of breakage resistance and long dependable use
- Saves space
- Easily penetrates most types of insulation
- No need to strip the conductor which saves installation time
- Break out easily by hand
- Prevents oxidation and moisture from entering the contact area
- Can be used as a splice or tap connector
- Contains no external energized parts.
- Provides a visual guide for proper installation of conductors



PART NO	WIRE MAIN	WIRE TAP	VOLTS	L	W	H
IPCO-4006	4/0 - #4 AWG	#6 - #14 AWG	600	1.42	1.00	1.88
IPCO-2540	250 MCM - #1 AWG	4/0 - #6 AWG	600	1.88	2.34	3.34

All wire sizes, unless noted otherwise, are American Wire Gauge (AWG)



PART NO	WIRE MAIN	WIRE TAP	VOLTS	L	W	H
IPCO-1002	1/0 - #8 AWG	#2 - #8 AWG	300	1.22	1.47	2.31
IPCO-4020	4/0 - #2 AWG	2/0 - #6 AWG	600	1.66	1.88	2.88
IPCO-3540	350 MCM - 4/0 AWG	4/0 - #10 AWG	300	1.67	2.44	3.13

All wire sizes, unless noted otherwise, are American Wire Gauge (AWG)



PART NO	WIRE MAIN	WIRE TAP	VOLTS	L	W	H
IPCO-5012	500 - 250 MCM	#10 - #12 AWG	300	1.67	2.44	3.25
IPCO-5025	500 - 250 MCM	250 - #4 AWG	600	1.42	2.91	3.75
IPCO-5030	500 - 300 MCM	500 - 250 MCM	600	3.19	3.63	5.00
IPCO-7550	750 - 500 MCM	500 - 350 MCM	600	3.19	3.63	5.00

All wire sizes, unless noted otherwise, are American Wire Gauge (AWG)



PART NO	WIRE MAIN	WIRE TAP	VOLTS	L	W	H
IPCO-3540	350-4/0	350-4/0	300	1.67	2.44	3.25

All wire sizes, unless noted otherwise, are American Wire Gauge (AWG)



# GROUNDING CLAMPS

## REGULAR DUTY ACORN STYLE



PART NO	WIRE RANGE	ROD SIZE
GRCA-0102	#10 SOL - #2 STR	1/2"
GRCA-0508	#10 SOL - #2 STR	5/8"
GRCA-0304	#10 SOL - #2 STR	3/4"

All wire sizes, unless noted otherwise, are American Wire Gauge (AWG)

## HEAVY DUTY ACORN STYLE



PART NO	WIRE RANGE	ROD SIZE
GRCA-1308	#10 SOL - #4 STR	3/8"
GRCA-1102	#10 SOL - #2 STR	1/2"
GRCA-1508	#8 SOL - 1/0 STR	5/8"
GRCA-1304	#8 SOL - 1/0 STR	3/4"
GRCA-1000	#8 SOL - 4/0 STR	1"

All wire sizes, unless noted otherwise, are American Wire Gauge (AWG)

## UNIVERSAL ACORN STYLE



PART NO	WIRE RANGE	ROD SIZE
GSRC-1000	#8 SOL - 1/0 STR	1/2", 5/8", 3/4"

All wire sizes, unless noted otherwise, are American Wire Gauge (AWG)

## CABLE TRAY GROUNDING CLAMP

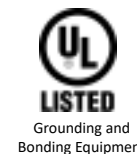

### Features

- Manufactured from tin plated high strength copper alloy
- Furnished with stainless steel bolt, nut and lock washer
- Internatl Hex Drive for maximum torque
- Accomodates multiple rebar sizes
- May be mounted to aluminum or galvanized steel cable tray
- UL 467 Listed for Grounding and Bonding
- Suitable for Direct Burial in earth or concrete

PART NO	WIRE RANGE	REBAR SIZE
GCCT-1006	1/0 STR - #6 SOL	3/8", 1/2", 5/8"
GCCT-2002	2/0 STR - #2 SOL	3/8", 1/2"
GCCT-2520	250 MCM - 2/0 STR	3/8"

All wire sizes, unless noted otherwise, are American Wire Gauge (AWG)





# GROUNDING CLAMPS

## DIRECT BURIAL WATER PIPE STYLE

- For connecting ground conductor to steel, copper pipe, tubing or grounding rods
- Constructed from bronze alloy and silicon bronze screws for direct burial in earth and concrete

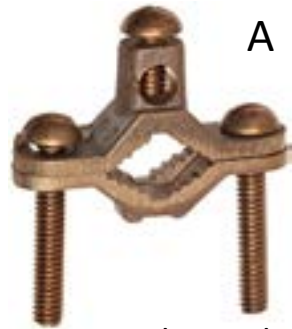

Pass-Thru Std.



Lay-in Parallel



Lay-in 90°

 DIRECT BURIAL Grounding and Bonding Equipment	PART NO	FIGURE	WIRE RANGE	PIPE RANGE	SCREW TYPE
	GCDB-0205	A	#10 AWG - #2 AWG	1/2" - 1"	SIL BRONZE
GCDB-0212	A	#10 AWG - #2 AWG	1-1/4" - 2"	SIL BRONZE	
GCDB-0225	A	#10 AWG - #2 AWG	2-1/2" - 4"	SIL BRONZE	
GJLA-0205	B	#10 AWG - #2 AWG	1/2" - 1"	SIL BRONZE	
GJRD-0205	C	#10 AWG - #2 AWG	1/2" - 1"	SIL BRONZE	

All wire sizes, unless noted otherwise, are American Wire Gauge (AWG)

## DIRECT BURIAL WATER PIPE STYLE 4/0 WIRE



Armored Cable or 4/0 cable

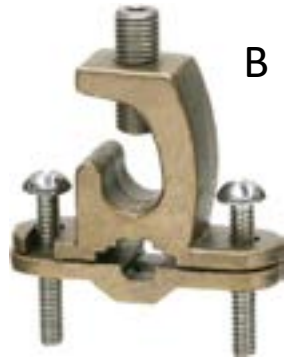

Lay-In Parallel 4/0



Pass-Thru 4/0

 DIRECT BURIAL Grounding and Bonding Equipment	PART NO	FIGURE	WIRE RANGE	PIPE RANGE	SCREW TYPE
	GCAB-4005	A	4/0 - #8 AWG	1/2" - 1"	SIL BRONZE
GCAB-4012	A	4/0 - #8 AWG	1-1/4" - 2"	SIL BRONZE	
GCAB-4025	A	4/0 - #8 AWG	2-1/2" - 4"	SIL BRONZE	
GCAB-4045	A	4/0 - #8 AWG	4-1/2" - 6"	SIL BRONZE	
GCLA-4005	B	4/0 - #8 AWG	1/2" - 1"	STAINLESS STEEL	
GCDB-4005	C	4/0 - #8 AWG	1/2" - 1"	STAINLESS STEEL	

All wire sizes, unless noted otherwise, are American Wire Gauge (AWG)



# GROUNDING CLAMPS

## WATER PIPE CLAMPS



PART NO	WIRE RANGE	PIPE RANGE	SCREW TYPE
GCSS-0205	#10 - #2 AWG	1/2" - 1"	ZINC STEEL
GCSS-0212	#10 - #2 AWG	1-1/4" - 2"	ZINC STEEL
GCSS-0225	#10 - #2 AWG	2-1/2" - 4"	ZINC STEEL
GCSS-0245	#10 - #2 AWG	4-1/2" - 6"	ZINC STEEL

All wire sizes, unless noted otherwise, are American Wire Gauge (AWG)

## WATER PIPE CLAMPS FOR ARMORED CABLE OR 4/0 WIRE



PART NO	WIRE RANGE	PIPE RANGE	SCREW TYPE
GCAC-4005	4/0 - #8 AWG	1/2" - 1"	ZINC STEEL
GCAC-4012	4/0 - #8 AWG	1-1/4" - 2"	ZINC STEEL
GCAC-4025	4/0 - #8 AWG	2-1/2" - 4"	ZINC STEEL
GCAC-4045	4/0 - #8 AWG	4-1/2" - 6"	ZINC STEEL

All wire sizes, unless noted otherwise, are American Wire Gauge (AWG)

## WATER PIPE CLAMP w/ CONDUIT HUB



A Fixed Hub



B Swivel Type



PIPE RANGE	MODEL	1/2" CONDUIT	3/4" CONDUIT	1" CONDUIT	WIRE RANGE	SCREW TYPE
1/2" - 1"	A	GCC0-1205	GCC0-3405	GCC0-1005	#10 - 2/0 AWG	ZINC STEEL
1-1/4" - 2"	A	GCC0-1212	GCC0-3412	GCC0-1012	#10 - 2/0 AWG	ZINC STEEL
2-1/2" - 4"	A	GCC0-1225	GCC0-3425	GCC0-1025	#10 - 2/0 AWG	ZINC STEEL
1/2" - 1"	B	GCSW-1205	GCSW-3405	GCSW-1005	#10 - #2 AWG	ZINC STEEL
1-1/4" - 2"	B	GCSW-1212	GCSW-3412	GCSW-1012	#10 - #2 AWG	ZINC STEEL
2-1/2" - 4"	B	GCSW-1225	GCSW-3425	GCSW-1025	#10 - #2 AWG	ZINC STEEL

## Hub Assembly



PART NO	CONDUIT SIZE	WIRE RANGE	SCREW TYPE
GCHB-0005	1/2"	#10 - 2/0 AWG	ZINC STEEL
GCHB-0007	3/4"	#10 - 2/0 AWG	ZINC STEEL
GCHB-0010	1"	#10 - 2/0 AWG	ZINC STEEL

All wire sizes, unless noted otherwise, are American Wire Gauge (AWG)



# GROUNDING CLAMPS

## U-BOLT GROUNDING CLAMPS



Parallel cable connection to rod or pipe. Made from high copper content alloy. Furnished with silicon bronze bolt, nuts and lockwashers.

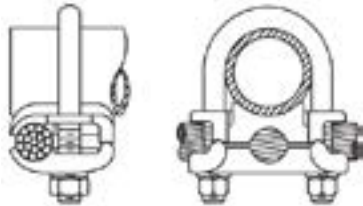

Universal parallel or 90° cable connection to rod or pipe.



PART NO	WIRE RANGE	ROD SIZE	PIPE SIZE	SCREW SIZE
GCUC-0100	8 SOL-4 STR	1/2"	1/4"	3/8"
GCUC-0101	4 SOL - 2/0 STR	1/2"	1/4"	3/8"
GCUC-0102	2/0 SOL - 250 MCM	1/2"	1/4"	3/8"
GCUC-0103	8 SOL-4 STR	5/8" or 3/4"	3/8"	3/8"
GCUC-0104	4 SOL - 2/0 STR	5/8" or 3/4"	3/8"	3/8"
GCUC-0105	2/0 SOL - 250 MCM	5/8" or 3/4"	3/8"	3/8"
GCUC-0106	300 - 500 MCM	5/8" or 1"	3/8" or 3/4"	1/2"
GCUC-0107	8 SOL-4 STR	7/8" or 1"	1/2" or 3/4"	3/8"
GCUC-0108	4 SOL - 2/0 STR	7/8" or 1"	1/2" or 3/4"	3/8"
GCUC-0109	2/0 SOL - 250 MCM	7/8" or 1"	1/2" or 3/4"	3/8"
GCUC-0110	500 - 750 CM	7/8" or 1"	1/2" or 3/4"	1/2"
GCUC-0111	750 - 1000 MCM	7/8" or 1"	1/2" or 3/4"	1/2"
GCUC-0112	8 SOL-4 STR	N/A	1"	3/8"
GCUC-0113	4 SOL - 2/0 STR	N/A	1"	3/8"
GCUC-0114	2/0 SOL - 250 MCM	N/A	1"	3/8"
GCUC-0115	300 - 500 MCM	N/A	1"	1/2"
GCUC-0116	500 - 750 MCM	N/A	1"	1/2"
GCUC-0117	750 - 1000 MCM	N/A	1"	1/2"
GCUC-0118	8 SOL-4 STR	N/A	1-1/4"	3/8"
GCUC-0119	4 SOL - 2/0 STR	N/A	1-1/4"	3/8"
GCUC-0120	2/0 SOL - 250 MCM	N/A	1-1/4"	3/8"
GCUC-0121	300 - 500 MCM	N/A	1-1/4"	1/2"
GCUC-0122	500 - 750 MCM	N/A	1-1/4"	1/2"
GCUC-0123	750 - 1000 MCM	N/A	1-1/4"	1/2"
GCUC-0124	8 SOL-4 STR	N/A	1-1/2"	3/8"
GCUC-0125	4 SOL - 2/0 STR	N/A	1-1/2"	3/8"
GCUC-0126	2/0 SOL - 250 MCM	N/A	1-1/2"	3/8"
GCUC-0127	300 - 500 MCM	N/A	1-1/2"	1/2"
GCUC-0128	500 - 750 MCM	N/A	1-1/2"	1/2"
GCUC-0129	750 - 1000 MCM	N/A	1-1/2"	1/2"
GCUC-0130	8 SOL-4 STR	N/A	2"	3/8"
GCUC-0131	4 SOL - 2/0 STR	N/A	2"	3/8"
GCUC-0132	2/0 SOL - 250 MCM	N/A	2"	3/8"
GCUC-0133	300 - 500 MCM	N/A	2"	1/2"
GCUC-0134	500 - 750 MCM	N/A	2"	1/2"
GCUC-0135	750 - 1000 MCM	N/A	2"	1/2"

All wire sizes, unless noted otherwise, are American Wire Gauge (AWG)



# MECHANICAL GROUNDING

## DUAL RATED WATER PIPE CLAMPS



FOR COPPER AND ALUMINUM CABLE  
GCAL ground clamps are UL listed for use with either copper or aluminum conductors to copper water pipe, galvanized pipe or steel conduit. All clamps are constructed from tin plated high-strength extruded aluminum alloy. CUAL oxide inhibiting joint compounds are recommended for all aluminum applications.

PART NO	PIPE SIZE	CONDUCTOR RANGE
GCAL-1005	1/2" - 1"	1/0 - #14 AWG
GCAL-25M12	1-1/4" - 2"	250 MCM - #6 AWG
GCAL-25M25	2-1/2" - 4"	250 MCM - #6 AWG

All wire sizes, unless noted otherwise, are American Wire Gauge (AWG)

## INTERSYSTEM BONDING DEVICE

- Fast & Simple Installation on Ground Conductor Below Meter
- Lay-in Feature allows Termination to existing Main Ground Electrode without Cutting or Splicing Conductor
- Open faced design allows installer to quickly lay-in the grounding conductor with no break in the ground conductor
- Four(4) Bonding Positions accommodate low voltage utility service ground wires
- Made of 6061-T6 Aluminum
- AL9CU Dual Rated For Copper or Aluminum Conductors
- Stainless Steel Flush Mount Slot Gead Screws
- UV Rated Paintable Thermoplastic Cover
- UL467 Listed, Meets NEC 2008 Section 250.94 Requirements



Main tap: #2 - #6 AWG  
Application Wire Range: #4 - #14 AWG

PART NO	H	W	L
ISBC-0424-C	1.40	1.19	3.93

All wire sizes, unless noted otherwise, are American Wire Gauge (AWG)

## LAY-IN COPPER GROUNDING LUG



Lay-in Copper Lugs are ideal for use on Grounding Swimming Pools, Spa Equipment, Conduit Bushings, and Jump to Multiple Conduits. Direct burial rated.

PART NO	CONDUCTOR SIZE	STUD SIZE	L	W	H
MCLA-0421-DB	#4 AWG - #14 AWG	#10	1.07	.38	.75

All wire sizes, unless noted otherwise, are American Wire Gauge (AWG)





# BOX GROUNDING

## SOLID GROUNDING PIG TAILS



We manufacture our grounding pigtails right here in Tampa, FL. Assembled from UL listed domestic THHN wire twisted around our distinctive combination drive grounding screw or optional type F thread cutting variety. Don't see the size or configuration you're looking for? We can provide custom lengths and gauges with minimal turnaround and small minimum orders.

PART NO	WIRE GAUGE	LENGTH	SCREW TYPE	PACKAGING
GRPG-1407-BP	14	6.5"	EASY START TIP	50/CLAM
GRPG-1207-CL	12	6.5"	EASY START TIP	100/BAG
GRPG-1207-BP	12	6.5"	EASY START TIP	50/CLAM
GRPG-1207-MK	12	6.5"	EASY START TIP	1000/BOX
GRPF-1207-BP	12	6.5"	TYPE F THREAD CUTTER	50/CLAM
GRPG-1275-BL	12	7.5"	EASY START TIP	50/BAG
GRPG-1210-BL	12	10"	EASY START TIP	50/BAG
GRPG-1212-BL	12	12"	EASY START TIP	50/BAG
GRPG-1075-CK	10	7.5"	EASY START TIP	100/BOX

## STRANDED GROUNDING PIG TAILS



PART NO	WIRE GAUGE	LENGTH	SCREW TYPE	ANNOTATION	PACKAGING
GRPS-1208-BL	12	8"	ES		50/BAG
GRPS-1208-NR-BL	12	8"	ES		50/BAG
GRPS-1208-D-BL	12	8"	ES	DUAL LEADS	50/BAG

## STRANDED MTW POWER LEADS



PART NO	WIRE GAUGE	LENGTH	COLOR	TERMINATIONS	PACKAGING
GRPS-1208-PR-NR	12	8"	RED	FORK (NO RING)	100/BOX
GRPS-1208-PB-NR	12	8"	BLACK	FORK (NO RING)	100/BOX
GRPS-1208-PW-NR	12	8"	WHITE	FORK (NO RING)	100/BOX
GRPS-1208-NR	12	8"	GREEN	FORK (NO RING)	100/BOX

PACKAGING: CLAM = CLEAR CLAMSHELL, RETAIL PACK BAG = POLY BAG, RETAIL BOX = WHOLESALE SHELF PACK



# BOX GROUNDING

## GROUNDING SCREWS



PART NO	PKG	PKG
GRSC-1303-JR	10-32 X 3/8" HEX WASHER HD SLOT/PHIL EASY START TIP	100/JAR
GRSC-1303-JRM	10-32 X 3/8" HEX WASHER HD SLOT/PHIL EASY START TIP	1000/JAR
GRSF-1303-JR	10-32 X 3/8" HEX WASHER HD SLOT TYPE F THREAD CUTTING	100/JAR

## GROUNDING CLIPS



Accommodates #12 and #14 copper and #12 aluminum solid conduction in non-metallic sheathed cable. Made of zinc-plated steel.

PART NO	COLOR	U/M
GRCL-1000	GREEN	100/BOX



## GROUNDING PUSH-IN WIRE CONNECTOR



Push wire connector for solid and stranded wire. Color coded green for use in junction boxes and many other grounding applications. Clear housing for visual inspection with built-in test port for troubleshooting.

PART NO	PKG	PORTS	COLOR	WIRE RANGE
WGGR-2112-JR	100/JAR	2	GREEN	#12 AWG - #16 AWG
WGGR-4114-JR	100/JAR	4	GREEN	#12 AWG - #16 AWG
WGGR-6116-JR	100/JAR	6	GREEN	#12 AWG - #16 AWG



## GROUNDING TWIST-ON WIRE CONNECTOR



Color coded Green for quick identification as a grounding conductor for copper wires only. Specifically designed for making positive ground connections and bonding non-metallic sheathed cable. Live-action square spring draws wires deep into the spring for a safe, tight grip ensuring an excellent connection. Swept-back design makes hand-tightening easy.

PART NO	COLOR	U/M	MIN WIRE RANGE	MAX WIRE RANGE
WNPW-1000-JR	GREEN	100/JAR	2 #14 AWG	4 #12 AWG
WNPW-1000-DL	GREEN	500/BAG	2 #14 AWG	4 #12 AWG



WIRE CONNECTOR

Visit us on the web at [www.posi-tech.com](http://www.posi-tech.com)





# BOX HARDWARE

## RECEPTACLE SPACERS



- Quick Fix Spacers adjust the length of receptacle or switches for proper fit of face plates.
- 4 inch stack of spacers twists apart easily for desired thickness
- Accepts #6, #8, #10 screws

PART NO	DESCRIPTION	PKG
BXSP-0400	4PCS PER STRIP	4 STRIPS/BAG
BXSP-1400	4 PCS PER STRIP	10 STRIPS/BOX

## BOX SUPPORTS

Our Box Supports enable the attachment of boxes in drywall & paneling, etc. where there are no means of attaching boxes.



PART NO	DESCRIPTION	PKG
BXDS-0200	GALV STEEL	100 PAIR/BOX

## ROUND COVER PLATES

5 Inch Diameter, 1/4 Inch Edge Taper - for 4 Inch Round/Octagon Boxes. These 5 Inch diameter, steel, white ceiling blank-up covers are used to cover electrical wires or unused recessed can light openings in ceilings or walls. With their tapered, 1/4 Inch outside edge, they are perfect for hiding oversize box openings or drywall and plaster imperfections.



PART NO	SPACING	COLOR
PLCW-0027	2-3/4"	ALMOND
PLCW-1027	2-3/4"	WHITE
PLCW-0035	3-1/2"	ALMOND
PLCW-1035	3-1/2"	WHITE

# SHEATHED CABLE TAP KITS



Non-metallic splice and tap kits provide a fast and reliable method for splicing or tapping 2 wire w/ ground and splicing 3 wire with ground non-metallic cables up to 300 volts. They are designed and approved for use in rework within existing structures. Splice and Tap Kits also eliminate wire connectors for installation and replace the conventional method for adding a splice or tap for non-metallic cable without the need for exposed and unsightly junction boxes. NEC approved Article 334-40b.



PART NO	TYPE	NM TYPE	PKG
RXSP-1220	SPLICE	12/2 W/GROUND	EACH
RXSP-1230	SPLICE	12/3 W/GROUND	EACH
RXTK-1230	TAP	12/2 W/GROUND	EACH

Each package contains two connectors (4 pcs total when unassembled).



# RECEPTACLE SCREWS

## 6-32 OVAL SLOT - ZINC PLATED STEEL W/ ENAMEL BAKED HEADS



- 6-32 thread
- Oval Head
- Milled slot drive

COLOR	5/16"	1/2"	3/4"	1"	1-1/2"	2"
WHITE	PLSW-6302-JR	PLSW-6305-JR	PLSW-6307-JR	PLSW-6310-JR	PLSW-6315-JR	PLSW-6320-JR
IVORY	PLSV-6302-JR	PLSV-6305-JR	PLSV-6307-JR	PLSV-6310-JR	PLSV-6315-JR	PLSV-6320-JR
ALMOND	PLSA-6302-JR	PLSA-6305-JR	PLSA-6307-JR	PLSA-6310-JR	PLSA-6315-JR	PLSA-6320-JR
LT ALMOND	PLSL-6302-JR	PLSL-6305-JR	PLSL-6307-JR	PLSL-6310-JR	PLSL-6315-JR	PLSL-6320-JR
RED	PLSR-6302-JR	PLSR-6305-JR	PLSR-6307-JR	PLSR-6310-JR	PLSR-6315-JR	PLSR-6320-JR
BLACK	PLSB-6302-JR	PLSB-6305-JR	PLSB-6307-JR	PLSB-6310-JR	PLSB-6315-JR	PLSB-6320-JR
TERACOTTA		PLST-6305-JR				
BROWN		PLSN-6305-JR				

Some lengths may require additional production times. Please contact customer service for availability.

## 6-32 OVAL SLOT - PREMIUM MATERIALS



We offer a wide selection of non-steel plates screws for a variety of aesthetics. Nylon plates screws provide a non-conductive plate fastening solutions.

COLOR	5/16"	1/2"	3/4"	1"	1-1/2"	2"
NICKEL		PLSI-6305-JR		PLSI-6310-JR		
BRASS	P6S0-6302-JR	P6S0-6305-JR	P6S0-6307-JR	P6S0-6310-JR	P6S0-6315-JR	P6S0-6320-JR
BRONZE		P4S0-6305-JR		P6S0-6310-JR		
NYLON	P7S0-6305-JR	P7S0-6305-JR	P7S0-6307-JR	P7S0-6310-JR	P7S0-6315-JR	P7S0-6320-JR

Some lengths may require additional production times. Please contact customer service for availability.

## 6-32 OVAL PHILLIPS - STAINLESS STEEL



For use in exterior and corrosive environments. Stainless steel plate screws provide a long lasting fastening solution.

COLOR	5/16"	1/2"	3/4"	1"	1-1/2"	2"
STAINLESS	P2SP-6302-JR	P2SP-6305-JR	P2SP-6307-JR	P2SP-6310-JR	P2SP-6315-JR	P2SP-6320-JR

Some lengths may require additional production times. Please contact customer service for availability.

## 6-32 OVAL SPANNER - STAINLESS STEEL



Oval head security screw utilizes the spanner drive for secure, long lasting fastening. Used primarily for securing box covers in areas where public access is to be restricted.

COLOR	5/16"	1/2"	3/4"	1"	1-1/2"	2"
STAINLESS	P2SP-6302-JR	P2SP-6305-JR	P2SP-6307-JR	P2SP-6310-JR	P2SP-6315-JR	P2SP-6320-JR

Some lengths may require additional production times. Please contact customer service for availability.





# SOLDERLESS NYLON TERMINALS

## RING TERMINALS

- Injection molded Nylon for superior heat resistance and long term durability
- Barrel constructed with V-groove serrations for maximum contact and tensile strength
- Pure copper construction with electro-tin plating for exceptional corrosion resistance



PART NO	PKG	COLOR	WIRE RANGE	STUD SIZE
NYRG-2206	100/BOX	RED	#22 - #18 AWG	6
NYRG-2208	100/BOX	RED	#22 - #18 AWG	8
NYRG-2210	100/BOX	RED	#22 - #18 AWG	10
NYRG-2214	100/BOX	RED	#22 - #18 AWG	1/4"
NYRG-2256	100/BOX	RED	#22 - #18 AWG	5/16"
NYRG-2238	100/BOX	RED	#22 - #18 AWG	3/8"
NYRG-1606	100/BOX	BLUE	#16 - #14 AWG	6
NYRG-1608	100/BOX	BLUE	#16 - #14 AWG	8
NYRG-1610	100/BOX	BLUE	#16 - #14 AWG	10
NYRG-1614	100/BOX	BLUE	#16 - #14 AWG	1/4"
NYRG-1656	100/BOX	BLUE	#16 - #14 AWG	5/16"
NYRG-1638	100/BOX	BLUE	#16 - #14 AWG	3/8"
NYRG-1612	100/BOX	BLUE	#16 - #14 AWG	1/2"
NYRG-1206	100/BOX	YELLOW	#12 - #10 AWG	6
NYRG-1208	100/BOX	YELLOW	#12 - #10 AWG	8
NYRG-1210	100/BOX	YELLOW	#12 - #10 AWG	10
NYRG-1214	100/BOX	YELLOW	#12 - #10 AWG	1/4"
NYRG-1256	100/BOX	YELLOW	#12 - #10 AWG	5/16"
NYRG-1238	100/BOX	YELLOW	#12 - #10 AWG	3/8"
NYRG-1212	100/BOX	YELLOW	#12 - #10 AWG	1/2"

## BUTT SPLICES

- Injection molded Nylon for superior heat resistance and long term durability
- Pure copper construction with electro-tin plating for exceptional corrosion resistance



PART NO	PKG	COLOR	WIRE RANGE
NYBT-2200	100/BOX	RED	#22 - #18 AWG
NYBT-1600	100/BOX	BLUE	#16 - #14 AWG
NYBT-1200	100/BOX	YELLOW	#12 - #10 AWG



# SOLDERLESS NYLON TERMINALS

## SPADE (FORK) TERMINALS

- Injection molded Nylon for superior heat resistance and long term durability
- Barrel constructed with V-groove serrations for maximum contact and tensile strength
- Pure copper construction with electro-tin plating for exceptional corrosion resistance



PART NO	PKG	COLOR	WIRE RANGE	STUD
NYSP-2206	100/BOX	RED	#22 - #18 AWG	6
NYSP-2208	100/BOX	RED	#22 - #18 AWG	8
NYSP-2210	100/BOX	RED	#22 - #18 AWG	10
NYSP-1606	100/BOX	BLUE	#16 - #14 AWG	6
NYSP-1608	100/BOX	BLUE	#16 - #14 AWG	8
NYSP-1610	100/BOX	BLUE	#16 - #14 AWG	10
NYSP-1206	100/BOX	YELLOW	#12 - #10 AWG	6
NYSP-1208	100/BOX	YELLOW	#12 - #10 AWG	8
NYSP-1210	100/BOX	YELLOW	#12 - #10 AWG	10
NYSP-1214	100/BOX	YELLOW	#12 - #10 AWG	1/4"

## FLANGED SPADE (FORK) TERMINALS



PART NO	PKG	COLOR	WIRE RANGE	STUD
NYFL-2206	100/BOX	RED	#22 - #18 AWG	6
NYFL-2208	100/BOX	RED	#22 - #18 AWG	8
NYFL-2210	100/BOX	RED	#22 - #18 AWG	10
NYFL-1606	100/BOX	BLUE	#16 - #14 AWG	6
NYFL-1608	100/BOX	BLUE	#16 - #14 AWG	8
NYFL-1610	100/BOX	BLUE	#16 - #14 AWG	10
NYFL-1206	100/BOX	YELLOW	#12 - #10 AWG	6
NYFL-1208	100/BOX	YELLOW	#12 - #10 AWG	8
NYFL-1210	100/BOX	YELLOW	#12 - #10 AWG	10

## SNAP SPADE (FORK) TERMINALS



PART NO	PKG	COLOR	WIRE RANGE	STUD
NYSS-2206	100/BOX	RED	#22 - #18 AWG	6
NYSS-2208	100/BOX	RED	#22 - #18 AWG	8
NYSS-2210	100/BOX	RED	#22 - #18 AWG	10
NYSS-1606	100/BOX	BLUE	#16 - #14 AWG	6
NYSS-1608	100/BOX	BLUE	#16 - #14 AWG	8
NYSS-1610	100/BOX	BLUE	#16 - #14 AWG	10
NYSS-1206	100/BOX	YELLOW	#12 - #10 AWG	6
NYSS-1208	100/BOX	YELLOW	#12 - #10 AWG	8
NYSS-1210	100/BOX	YELLOW	#12 - #10 AWG	10



# SOLDERLESS NYLON TERMINALS

## NYLON QUICK DISCONNECTS

- Injection molded Nylon for superior heat resistance and long term durability
- Barrel constructed with V-groove serrations for maximum contact and tensile strength
- Pure copper construction with electro-tin plating for exceptional corrosion resistance



PART NO	PKG	COLOR	WIRE RANGE	BLADE
NYQM-2236	100/BOX	RED	#22 - #18 AWG	3/16"
NYQM-2214	100/BOX	RED	#22 - #18 AWG	1/4"
NYQM-1636	100/BOX	BLUE	#16 - #14 AWG	3/16"
NYQM-1614	100/BOX	BLUE	#16 - #14 AWG	1/4"
NYQM-1214	100/BOX	YELLOW	#12 - #10 AWG	1/4"
NYQF-2236	100/BOX	RED	#22 - #18 AWG	3/16"
NYQF-2214	100/BOX	RED	#22 - #18 AWG	1/4"
NYQF-1636	100/BOX	BLUE	#16 - #14 AWG	3/16"
NYQF-1614	100/BOX	BLUE	#16 - #14 AWG	1/4"
NYQF-1214	100/BOX	YELLOW	#12 - #10 AWG	1/4"

## NYLON FULLY INSULATED QUICK DISCONNECTS



PART NO	PKG	COLOR	WIRE RANGE	STUD
NYFM-2236	100/BOX	RED	#22 - #18 AWG	3/16"
NYFM-2214	100/BOX	RED	#22 - #18 AWG	1/4"
NYFM-1636	100/BOX	BLUE	#16 - #14 AWG	3/16"
NYFM-1614	100/BOX	BLUE	#16 - #14 AWG	1/4"
NYFM-1214	50/BOX	YELLOW	#12 - #10 AWG	1/4"
NYFF-2236	100/BOX	RED	#22 - #18 AWG	3/16"
NYFF-2214	100/BOX	RED	#22 - #18 AWG	1/4"
NYFF-1636	100/BOX	BLUE	#16 - #14 AWG	3/16"
NYFF-1614	100/BOX	BLUE	#16 - #14 AWG	1/4"
NYFF-1214	50/BOX	YELLOW	#12 - #10 AWG	1/4"

## NYLON FULLY INSULATED FLAG TERMINALS



PART NO	PKG	COLOR	WIRE RANGE	STUD
NYFG-2236	100/BOX	RED	#22 - #18 AWG	3/16"
NYFG-2214	100/BOX	RED	#22 - #18 AWG	1/4"
NYFG-1636	100/BOX	BLUE	#16 - #14 AWG	3/16"
NYFG-1614	100/BOX	BLUE	#16 - #14 AWG	1/4"
NYFG-1214	100/BOX	YELLOW	#12 - #10 AWG	1/4"

# SOLDERLESS NYLON TERMINALS



## NYLON BULLET CONNECTORS



PART NO	PKG	COLOR	WIRE RANGE	STUD
NYBM-2215	100/BOX	RED	#22 - #18 AWG	3/16"
NYBM-1615	100/BOX	RED	#22 - #18 AWG	1/4"
NYBF-2215	100/BOX	BLUE	#16 - #14 AWG	3/16"
NYBF-1615	100/BOX	BLUE	#16 - #14 AWG	1/4"

## NYLON CLOSED END PIG TAIL CONNECTORS



- Made from nylon 6/6
- UL 94V-2 Self Extinguishing
- Temperature Rating: 105 °C (221 °F).
- 300V rated

PART NO	PKG	MIN WIRE RANGE	MAX WURE RANGE
NYPG-2200	100/BOX	2 #20 W/1 #18 AWG	2 #22 AWG
NYPG-1800	100/BOX	1 #18 W/1 #14 AWG	2 #22 AWG
NYPG-1200	100/BOX	3 #14 AWG	2 #22 W/2 #18 AWG
NYPG-0800	50/BOX	2 #16 W/1 #10 AWG	2 #26 W/1 #12 AWG

Visit us on the web at  
[www.posi-tech.com](http://www.posi-tech.com)



### THE HISTORY OF SOLDERLESS TERMINALS

Solderless Terminals, also known as crimp connectors, were first invented in the 1940's by Aircraft Marine Products, known later as AMP Corporation. Until this time, wire connections were commonly soldered in place. Soldered connections were subject to joint fatigue resulting from vibration and other environmental factors. The introduction of solderless terminals created a gas tight connection that is vibration resistant and free from oxidation and resulting corrosion. A proper crimp will create what is known as a cold-weld, essentially combining the two metals together into a singular mass.





# SOLDERLESS VINYL TERMINALS

## SOLDERLESS VINYL RING TERMINALS

These Vinyl Ring Terminals are the most economical insulated terminals available. They feature a PVC insulated sleeve that is securely fastened to the seam barrel. They offer a flared entry to easy wire insertion and industry standard color coding for wire sizes.



PART NO	PKG	COLOR	WIRE RANGE	STUD SIZE
VNRG-2206	100/BOX	RED	#22 - #18 AWG	6
VNRG-2208	100/BOX	RED	#22 - #18 AWG	8
VNRG-2210	100/BOX	RED	#22 - #18 AWG	10
VNRG-2214	100/BOX	RED	#22 - #18 AWG	1/4"
VNRG-2256	100/BOX	RED	#22 - #18 AWG	5/16"
VNRG-2238	100/BOX	RED	#22 - #18 AWG	3/8"
VNRG-1606	100/BOX	BLUE	#16 - #14 AWG	6
VNRG-1608	100/BOX	BLUE	#16 - #14 AWG	8
VNRG-1610	100/BOX	BLUE	#16 - #14 AWG	10
VNRG-1614	100/BOX	BLUE	#16 - #14 AWG	1/4"
VNRG-1656	100/BOX	BLUE	#16 - #14 AWG	5/16"
VNRG-1638	100/BOX	BLUE	#16 - #14 AWG	3/8"
VNRG-1612	100/BOX	BLUE	#16 - #14 AWG	1/2"
VNRG-1206	100/BOX	YELLOW	#12 - #10 AWG	6
VNRG-1208	100/BOX	YELLOW	#12 - #10 AWG	8
VNRG-1210	100/BOX	YELLOW	#12 - #10 AWG	10
VNRG-1214	100/BOX	YELLOW	#12 - #10 AWG	1/4"
VNRG-1256	100/BOX	YELLOW	#12 - #10 AWG	5/16"
VNRG-1238	100/BOX	YELLOW	#12 - #10 AWG	3/8"
VNRG-1212	100/BOX	YELLOW	#12 - #10 AWG	1/2"

## SOLDERLESS VINYL BUTT SPLICES

These Vinyl Butt Splices are the most economical insulated terminals available. They feature a PVC insulated sleeve that is securely fastened to the seam barrel. They offer a flared entry to easy wire insertion and industry standard color coding for wire sizes.



PART NO	PKG	COLOR	WIRE RANGE	STUD SIZE
VNBT-2200	100/BOX	RED	#22 - #18 AWG	NA
VNBT-1600	100/BOX	BLUE	#16 - #14 AWG	NA
VNBT-1200	100/BOX	YELLOW	#12 - #10 AWG	NA



# SOLDERLESS VINYL TERMINALS

## SOLDERLESS RING TERMINALS - BRAZED SEAM

These Vinyl Ring Terminals feature a PVC insulated sleeve that is securely fastened to brazed barrel. The brazed barrel creates a virtually seamless crimp which helps to prevent defomation and misaligned crimps. They also offer a flared entry to easy wire insertion and industry standard color coding for wire sizes.



8 AWG - 4 AWG

PART NO	PKG	COLOR	WIRE RANGE	STUD SIZE
VBRG-0810	50	RED	#8 AWG	10
VBRG-0814	50	RED	#8 AWG	1/4"
VBRG-0856	50	RED	#8 AWG	5/16"
VBRG-0838	50	RED	#8 AWG	3/8"
VBRG-0812	50	RED	#8 AWG	1/2"
VBRG-0614	25	BLUE	#6 AWG	1/4"
VBRG-0656	25	BLUE	#6 AWG	5/16"
VBRG-0638	25	BLUE	#6 AWG	3/8"
VBRG-0612	25	BLUE	#6 AWG	1/2"
VBRG-0414	10	YELLOW	#4 AWG	1/4"
VBRG-0438	10	YELLOW	#4 AWG	3/8"
VBRG-0412	10	YELLOW	#4 AWG	1/2"

## SOLDERLESS VINYL BUTT SPLICES - BRAZED SEAM

These Vinyl Butt Splices feature a PVC insulated sleeve that is securely fastened to brazed barrel. The brazed barrel creates a virtually seamless crimp which helps to prevent defomation and misaligned crimps. They also offer a flared entry to easy wire insertion and industry standard color coding for wire sizes.



8 AWG - 4 AWG

PART NO	PKG	COLOR	WIRE RANGE
VBBT-0800	50	RED	#8 AWG
VBBT-0600	25	BLUE	#6 AWG
VBBT-0400	10	YELLOW	#4 AWG





# SOLDERLESS VINYL TERMINALS

## SPADE (FORK) TERMINALS



22 AWG - 10 AWG

- Injection molded Nylon for superior heat resistance and long term durability
- Barrel constructed with V-groove serrations for maximum contact and tensile strength
- Pure copper construction with electro-tin plating for exceptional corrosion resistance

PART NO	PKG	COLOR	WIRE RANGE	STUD
VNSP-2206	100/BOX	RED	#22 - #18 AWG	6
VNSP-2208	100/BOX	RED	#22 - #18 AWG	8
VNSP-2210	100/BOX	RED	#22 - #18 AWG	10
VNSP-1606	100/BOX	BLUE	#16 - #14 AWG	6
VNSP-1608	100/BOX	BLUE	#16 - #14 AWG	8
VNSP-1610	100/BOX	BLUE	#16 - #14 AWG	10
VNSP-1206	100/BOX	YELLOW	#12 - #10 AWG	6
VNSP-1208	100/BOX	YELLOW	#12 - #10 AWG	8
VNSP-1210	100/BOX	YELLOW	#12 - #10 AWG	10
VNSP-1214	100/BOX	YELLOW	#12 - #10 AWG	1/4"

## FLANGED SPADE (FORK) TERMINALS



22 AWG - 10 AWG

PART NO	PKG	COLOR	WIRE RANGE	STUD
VNFL-2206	100/BOX	RED	#22 - #18 AWG	6
VNFL-2208	100/BOX	RED	#22 - #18 AWG	8
VNFL-2210	100/BOX	RED	#22 - #18 AWG	10
VNFL-1606	100/BOX	BLUE	#16 - #14 AWG	6
VNFL-1608	100/BOX	BLUE	#16 - #14 AWG	8
VNFL-1610	100/BOX	BLUE	#16 - #14 AWG	10
VNFL-1206	100/BOX	YELLOW	#12 - #10 AWG	6
VNFL-1208	100/BOX	YELLOW	#12 - #10 AWG	8
VNFL-1210	100/BOX	YELLOW	#12 - #10 AWG	10

## SNAP SPADE (FORK) TERMINALS



22 AWG - 10 AWG

PART NO	PKG	COLOR	WIRE RANGE	STUD
VNSS-2206	100/BOX	RED	#22 - #18 AWG	6
VNSS-2208	100/BOX	RED	#22 - #18 AWG	8
VNSS-2210	100/BOX	RED	#22 - #18 AWG	10
VNSS-1606	100/BOX	BLUE	#16 - #14 AWG	6
VNSS-1608	100/BOX	BLUE	#16 - #14 AWG	8
VNSS-1610	100/BOX	BLUE	#16 - #14 AWG	10
VNSS-1206	100/BOX	YELLOW	#12 - #10 AWG	6
VNSS-1208	100/BOX	YELLOW	#12 - #10 AWG	8
VNSS-1210	100/BOX	YELLOW	#12 - #10 AWG	10

# SOLDERLESS VINYL TERMINALS



## QUICK DISCONNECTS



22 AWG - 10 AWG

- Barrel constructed with V-groove serrations for maximum contact and tensile strength
- Pure copper construction with electro-tin plating for exceptional corrosion resistance

PART NO	PKG	COLOR	WIRE RANGE	BLADE
VNQM-2236	100/BOX	RED	#22 - #18 AWG	3/16"
VNQM-2214	100/BOX	RED	#22 - #18 AWG	1/4"
VNQM-1636	100/BOX	BLUE	#16 - #14 AWG	3/16"
VNQM-1614	100/BOX	BLUE	#16 - #14 AWG	1/4"
VNQM-1214	100/BOX	YELLOW	#12 - #10 AWG	1/4"
VNQF-2236	100/BOX	RED	#22 - #18 AWG	3/16"
VNQF-2214	100/BOX	RED	#22 - #18 AWG	1/4"
VNQF-1636	100/BOX	BLUE	#16 - #14 AWG	3/16"
VNQF-1614	100/BOX	BLUE	#16 - #14 AWG	1/4"
VNQF-1214	100/BOX	YELLOW	#12 - #10 AWG	1/4"

## BULLET CONNECTORS



22 AWG - 10 AWG

- Barrel constructed with V-groove serrations for maximum contact and tensile strength
- Pure copper construction with electro-tin plating for exceptional corrosion resistance

PART NO	PKG	COLOR	WIRE RANGE	STUD
VNBM-2215	100/BOX	RED	#22 - #18 AWG	NA
VNBM-1615	100/BOX	RED	#22 - #18 AWG	NA
VNBF-2215	100/BOX	BLUE	#16 - #14 AWG	NA
VNBF-1615	100/BOX	BLUE	#16 - #14 AWG	NA

## PIGGY BACK TERMINALS



22 AWG - 10 AWG

- Barrel constructed with V-groove serrations for maximum contact and tensile strength
- Pure copper construction with electro-tin plating for exceptional corrosion resistance

PART NO	PKG	COLOR	WIRE RANGE	BLADE
VNPB-2214	100/BOX	RED	#22 - #18 AWG	1/4"
VNPB-1614	100/BOX	BLUE	#16 - #14 AWG	1/4"
VNPB-1214	50/BOX	YELLOW	#12 - #10 AWG	1/4"

## PIN TERMINALS



22 AWG - 10 AWG

- Barrel constructed with V-groove serrations for maximum contact and tensile strength
- Pure copper construction with electro-tin plating for exceptional corrosion resistance

PART NO	PKG	COLOR	WIRE RANGE	STUD
VNPN-2200	100/BOX	RED	#22 - #18 AWG	NA
VNPN-1600	100/BOX	BLUE	#16 - #14 AWG	NA
VNPN-1200	100/BOX	YELLOW	#12 - #10 AWG	NA



## RING TERMINALS



- Barrel constructed with V-groove serrations for maximum contact and tensile strength
- Pure copper construction with electro-tin plating for exceptional corrosion resistance

PART NO	PKG	COLOR	WIRE RANGE	STUD SIZE
NORG-2206	100/BOX	NA	#22 - #18 AWG	6
NORG-2208	100/BOX	NA	#22 - #18 AWG	8
NORG-2210	100/BOX	NA	#22 - #18 AWG	10
NORG-2214	100/BOX	NA	#22 - #18 AWG	1/4"
NORG-2256	100/BOX	NA	#22 - #18 AWG	5/16"
NORG-2238	100/BOX	NA	#22 - #18 AWG	3/8"
NORG-1606	100/BOX	NA	#16 - #14 AWG	6
NORG-1608	100/BOX	NA	#16 - #14 AWG	8
NORG-1610	100/BOX	NA	#16 - #14 AWG	10
NORG-1614	100/BOX	NA	#16 - #14 AWG	1/4"
NORG-1656	100/BOX	NA	#16 - #14 AWG	5/16"
NORG-1638	100/BOX	NA	#16 - #14 AWG	3/8"
NORG-1612	100/BOX	NA	#16 - #14 AWG	1/2"
NORG-1206	100/BOX	NA	#12 - #10 AWG	6
NORG-1208	100/BOX	NA	#12 - #10 AWG	8
NORG-1210	100/BOX	NA	#12 - #10 AWG	10
NORG-1214	100/BOX	NA	#12 - #10 AWG	1/4"
NORG-1256	100/BOX	NA	#12 - #10 AWG	5/16"
NORG-1238	100/BOX	NA	#12 - #10 AWG	3/8"
NORG-1212	100/BOX	NA	#12 - #10 AWG	1/2"

## BUTT SPLICES



- Pure copper construction with electro-tin plating for exceptional corrosion resistance

PART NO	PKG	COLOR	WIRE RANGE	STUD SIZE
NOBT-2200	100/BOX	NA	#22 - #18 AWG	NA
NOBT-1600	100/BOX	NA	#16 - #14 AWG	NA
NOBT-1200	100/BOX	NA	#12 - #10 AWG	NA

## SPADE (FORK) TERMINALS



- Barrel constructed with V-groove serrations for maximum contact and tensile strength
- Pure copper construction with electro-tin plating for exceptional corrosion resistance

PART NO	PKG	COLOR	WIRE RANGE	STUD
NOSP-2206	100/BOX	NA	#22 - #18 AWG	6
NOSP-2208	100/BOX	NA	#22 - #18 AWG	8
NOSP-2210	100/BOX	NA	#22 - #18 AWG	10
NOSP-1606	100/BOX	NA	#16 - #14 AWG	6
NOSP-1608	100/BOX	NA	#16 - #14 AWG	8
NOSP-1610	100/BOX	NA	#16 - #14 AWG	10
NOSP-1206	100/BOX	NA	#12 - #10 AWG	6
NOSP-1208	100/BOX	NA	#12 - #10 AWG	8
NOSP-1210	100/BOX	NA	#12 - #10 AWG	10
NOSP-1214	100/BOX	NA	#12 - #10 AWG	1/4"

## FLANGED SPADE (FORK) TERMINALS



PART NO	PKG	COLOR	WIRE RANGE	STUD
NOFL-2206	100/BOX	NA	#22 - #18 AWG	6
NOFL-2208	100/BOX	NA	#22 - #18 AWG	8
NOFL-2210	100/BOX	NA	#22 - #18 AWG	10
NOFL-1606	100/BOX	NA	#16 - #14 AWG	6
NOFL-1608	100/BOX	NA	#16 - #14 AWG	8
NOFL-1610	100/BOX	NA	#16 - #14 AWG	10
NOFL-1206	100/BOX	NA	#12 - #10 AWG	6
NOFL-1208	100/BOX	NA	#12 - #10 AWG	8
NOFL-1210	100/BOX	NA	#12 - #10 AWG	10

## SNAP SPADE (FORK) TERMINALS



PART NO	PKG	COLOR	WIRE RANGE	STUD
NOSS-2206	100/BOX	NA	#22 - #18 AWG	6
NOSS-2208	100/BOX	NA	#22 - #18 AWG	8
NOSS-2210	100/BOX	NA	#22 - #18 AWG	10
NOSS-1606	100/BOX	NA	#16 - #14 AWG	6
NOSS-1608	100/BOX	NA	#16 - #14 AWG	8
NOSS-1610	100/BOX	NA	#16 - #14 AWG	10
NOSS-1206	100/BOX	NA	#12 - #10 AWG	6
NOSS-1208	100/BOX	NA	#12 - #10 AWG	8
NOSS-1210	100/BOX	NA	#12 - #10 AWG	10



# SOLDERLESS NON-INSULATED TERMINALS

## QUICK DISCONNECTS



- Barrel constructed with V-groove serrations for maximum contact and tensile strength
- Pure copper construction with electro-tin plating for exceptional corrosion resistance

PART NO	PKG	COLOR	WIRE RANGE	BLADE
NOQM-2236	100/BOX	RED	#22 - #18 AWG	3/16"
NOQM-2214	100/BOX	RED	#22 - #18 AWG	1/4"
NOQM-1636	100/BOX	BLUE	#16 - #14 AWG	3/16"
NOQM-1614	100/BOX	BLUE	#16 - #14 AWG	1/4"
NOQM-1214	100/BOX	YELLOW	#12 - #10 AWG	1/4"
NOQF-2236	100/BOX	RED	#22 - #18 AWG	3/16"
NOQF-2214	100/BOX	RED	#22 - #18 AWG	1/4"
NOQF-1636	100/BOX	BLUE	#16 - #14 AWG	3/16"
NOQF-1614	100/BOX	BLUE	#16 - #14 AWG	1/4"
NOQF-1214	100/BOX	YELLOW	#12 - #10 AWG	1/4"

## FLAG TERMINALS



PART NO	PKG	COLOR	WIRE RANGE	STUD
NOFG-2236	100/BOX	NA	#22 - #18 AWG	3/16"
NOFG-2214	100/BOX	NA	#22 - #18 AWG	1/4"
NOFG-1636	100/BOX	NA	#16 - #14 AWG	3/16"
NOFG-1614	100/BOX	NA	#16 - #14 AWG	1/4"
NOFG-1214	100/BOX	NA	#12 - #10 AWG	1/4"



Visit us on the web at  
[www.posi-tech.com](http://www.posi-tech.com)



# BRASS DISCONNECT TERMINALS

## PIGGY-BACK 3-WAY IN SERIES



- Solid brass construction
- Male / Male / Female "in series" piggyback configuration

PART NO	PKG	BLADE/RECEPTACLE
NOPB-0014	100/BOX	1/4" (.250)

## SIDE-BY-SIDE 3-WAY PARALLEL



- Solid brass construction
- Male / Male / Female side-by-side configuration

PART NO	PKG	BLADE/RECEPTACLE
NOVW-0014	100/BOX	1/4" (.250)

## CHAIR STYLE 3-WAY PARALLEL



- Solid brass construction
- Male / Male / Female 90° side by side configuration

PART NO	PKG	BLADE/RECEPTACLE
NOCH-0014	100/BOX	1/4" (.250)

## STUD MOUNT TABS



- Solid brass construction
- Stud mount tab for disconnect receptacles

PART NO	PKG	STUD SIZE	BLADE
NOTB-0614	100/BOX	#6	1/4" (.250)
NOTB-0814	100/BOX	#8	1/4" (.250)
NOTB-1014	100/BOX	#10	1/4" (.250)



# HIGH-TEMP SOLDERLESS TERMINALS

## SPADE (FORK) TERMINALS



HIGH  
TEMP



PART NO	PKG	COLOR	WIRE RANGE	STUD SIZE
HTSP-2206	100/BOX	NA	#22 - #18 AWG	6
HTSP-2208	100/BOX	NA	#22 - #18 AWG	8
HTSP-2210	100/BOX	NA	#22 - #18 AWG	10
HTSP-1606	100/BOX	NA	#16 - #14 AWG	6
HTSP-1608	100/BOX	NA	#16 - #14 AWG	8
HTSP-1610	100/BOX	NA	#16 - #14 AWG	10
HTSP-1206	100/BOX	NA	#12 - #10 AWG	6
HTSP-1208	100/BOX	NA	#12 - #10 AWG	8
HTSP-1210	100/BOX	NA	#12 - #10 AWG	10





# HIGH-TEMP SOLDERLESS TERMINALS

## RING TERMINALS



- Barrel constructed with V-groove serrations for maximum contact and tensile strength
- Pure copper construction with electro-tin plating for exceptional corrosion resistance

PART NO	PKG	COLOR	WIRE RANGE	STUD SIZE
HTRG-2206	100/BOX	NA	#22 - #18 AWG	6
HTRG-2208	100/BOX	NA	#22 - #18 AWG	8
HTRG-2210	100/BOX	NA	#22 - #18 AWG	10
HTRG-1606	100/BOX	NA	#16 - #14 AWG	6
HTRG-1608	100/BOX	NA	#16 - #14 AWG	8
HTRG-1610	100/BOX	NA	#16 - #14 AWG	10
HTRG-1206	100/BOX	NA	#12 - #10 AWG	6
HTRG-1208	100/BOX	NA	#12 - #10 AWG	8
HTRG-1210	100/BOX	NA	#12 - #10 AWG	10
HTRG-1214	100/BOX	NA	#12 - #10 AWG	1/4"
HTRG-1256	100/BOX	NA	#12 - #10 AWG	5/16"
HTRG-1238	100/BOX	NA	#12 - #10 AWG	3/8"

## BUTT SPLICES



PART NO	PKG	COLOR	WIRE RANGE	STUD SIZE
HTBT-2200	100/BOX	NA	#22 - #18 AWG	NA
HTBT-1600	100/BOX	NA	#16 - #14 AWG	NA
HTBT-1200	100/BOX	NA	#12 - #10 AWG	NA

## QUICK DISCONNECTS



PART NO	PKG	COLOR	WIRE RANGE	BLADE
HTQM-2236	100/BOX	RED	#22 - #18 AWG	3/16"
HTQM-2214	100/BOX	RED	#22 - #18 AWG	1/4"
HTQM-1636	100/BOX	BLUE	#16 - #14 AWG	3/16"
HTQM-1614	100/BOX	BLUE	#16 - #14 AWG	1/4"
HTQM-1214	100/BOX	YELLOW	#12 - #10 AWG	1/4"
HTQF-2236	100/BOX	RED	#22 - #18 AWG	3/16"
HTQF-2214	100/BOX	RED	#22 - #18 AWG	1/4"
HTQF-1636	100/BOX	BLUE	#16 - #14 AWG	3/16"
HTQF-1614	100/BOX	BLUE	#16 - #14 AWG	1/4"
HTQF-1214	100/BOX	YELLOW	#12 - #10 AWG	1/4"



# HEAT SHRINK TERMINALS

## RING TERMINALS



- Barrel constructed with V-groove serrations for maximum contact and tensile strength
- Pure copper construction with electro-tin plating for exceptional corrosion resistance

PART NO	PKG	COLOR	WIRE RANGE	STUD SIZE
NHRG-2206	100/BOX	NA	#22 - #18 AWG	6
NHRG-2208	100/BOX	NA	#22 - #18 AWG	8
NHRG-2210	100/BOX	NA	#22 - #18 AWG	10
NHRG-2214	100/BOX	NA	#22 - #18 AWG	1/4"
NHRG-2256	100/BOX	NA	#22 - #18 AWG	5/16"
NHRG-2238	100/BOX	NA	#22 - #18 AWG	3/8"
NHRG-1606	100/BOX	NA	#16 - #14 AWG	6
NHRG-1608	100/BOX	NA	#16 - #14 AWG	8
NHRG-1610	100/BOX	NA	#16 - #14 AWG	10
NHRG-1614	100/BOX	NA	#16 - #14 AWG	1/4"
NHRG-1656	100/BOX	NA	#16 - #14 AWG	5/16"
NHRG-1638	100/BOX	NA	#16 - #14 AWG	3/8"
NHRG-1612	100/BOX	NA	#16 - #14 AWG	1/2"
NHRG-1206	100/BOX	NA	#12 - #10 AWG	6
NHRG-1208	100/BOX	NA	#12 - #10 AWG	8
NHRG-1210	100/BOX	NA	#12 - #10 AWG	10
NHRG-1214	100/BOX	NA	#12 - #10 AWG	1/4"
NHRG-1256	100/BOX	NA	#12 - #10 AWG	5/16"
NHRG-1238	100/BOX	NA	#12 - #10 AWG	3/8"
NHRG-1212	100/BOX	NA	#12 - #10 AWG	1/2"

## BUTT SPLICES



- Injection molded Nylon for superior heat resistance and long term durability
- Pure copper construction with electro-tin plating for exceptional corrosion resistance

PART NO	PKG	COLOR	WIRE RANGE	STUD SIZE
NHBT-2200	100/BOX	NA	#22 - #18 AWG	NA
NHBT-1600	100/BOX	NA	#16 - #14 AWG	NA
NHBT-1200	100/BOX	NA	#12 - #10 AWG	NA





# HEAT SHRINK TERMINALS

## SPADE (FORK) TERMINALS



- Injection molded Nylon for superior heat resistance and long term durability
- Barrel constructed with V-groove serrations for maximum contact and tensile strength
- Pure copper construction with electro-tin plating for exceptional corrosion resistance

PART NO	PKG	COLOR	WIRE RANGE	STUD
NHSP-2206-BP	50	RED	22-18 AWG	6
NHSP-2208-BP	50	RED	22-18 AWG	8
NHSP-2210-BP	50	RED	22-18 AWG	10
NHSP-1606-BP	50	BLUE	16-14 AWG	6
NHSP-1608-BP	50	BLUE	16-14 AWG	8
NHSP-1610-BP	50	BLUE	16-14 AWG	10
NHSP-1206-BP	50	YELLOW	12-10 AWG	6
NHSP-1208-BP	50	YELLOW	12-10 AWG	8
NHSP-1210-BP	50	YELLOW	12-10 AWG	10

## QUICK DISCONNECTS - PARTIALLY INSULATED



- Injection molded Nylon for superior heat resistance and long term durability
- Barrel constructed with V-groove serrations for maximum contact and tensile strength
- Pure copper construction with electro-tin plating for exceptional corrosion resistance

PART NO	TYPE	PKG	COLOR	WIRE RANGE	BLADE
NHQF-2214-BP	FEMALE	50	RED	22-18 AWG	1/4"
NHQM-2214-BP	MALE	50	RED	22-18 AWG	1/4"
NHQF-1614-BP	FEMALE	50	BLUE	16-14 AWG	1/4"
NHQM-1614-BP	MALE	50	BLUE	16-14 AWG	1/4"
NHQF-1214-BP	FEMALE	50	YELLOW	12-10 AWG	1/4"
NHQM-1214-BP	MALE	50	YELLOW	12-10 AWG	1/4"

## QUICK DISCONNECTS - FULLY INSULATED



- Injection molded Nylon for superior heat resistance and long term durability
- Barrel constructed with V-groove serrations for maximum contact and tensile strength
- Pure copper construction with electro-tin plating for exceptional corrosion resistance

PART NO	TYPE	PKG	COLOR	WIRE RANGE	BLADE
NHFF-2214-BP	FEMALE	50	RED	22-18 AWG	1/4"
NHFM-2214-BP	MALE	50	RED	22-18 AWG	1/4"
NHFF-1614-BP	FEMALE	50	BLUE	16-14 AWG	1/4"
NHFM-1614-BP	MALE	50	BLUE	16-14 AWG	1/4"
NHFF-1214-BP	FEMALE	50	YELLOW	12-10 AWG	1/4"
NHFM-1214-BP	MALE	50	YELLOW	12-10 AWG	1/4"



# TS PACK SOLDERLESS TERMINALS

## RING TERMINALS - TS RETAIL PACKS



- Barrel constructed with V-groove serrations for maximum contact and tensile strength
- Pure copper construction with electro-tin plating for exceptional corrosion resistance

PART NO	PKG	COLOR	WIRE RANGE	STUD
VNRG-2206-TS	25/BOX	RED	#22 - #18 AWG	6
VNRG-2208-TS	25/BOX	RED	#22 - #18 AWG	8
VNRG-2210-TS	25/BOX	RED	#22 - #18 AWG	10
VNRG-2214-TS	25/BOX	RED	#22 - #18 AWG	1/4"
VNRG-2238-TS	25/BOX	RED	#22 - #18 AWG	3/8"
VNRG-1606-TS	25/BOX	BLUE	#16 - #14 AWG	6
VNRG-1608-TS	25/BOX	BLUE	#16 - #14 AWG	8
VNRG-1610-TS	25/BOX	BLUE	#16 - #14 AWG	10
VNRG-1614-TS	25/BOX	BLUE	#16 - #14 AWG	1/4"
VNRG-1206-TS	15/BOX	YELLOW	#12 - #10 AWG	6
VNRG-1208-TS	15/BOX	YELLOW	#12 - #10 AWG	8
VNRG-1210-TS	15/BOX	YELLOW	#12 - #10 AWG	10
VNRG-1214-TS	15/BOX	YELLOW	#12 - #10 AWG	1/4"

## BUTT SPLICES - TS RETAIL PACKS



PART NO	PKG	COLOR	WIRE RANGE	STUD
VNBT-2200-TS	25/BOX	RED	#22 - #18 AWG	NA
VNBT-1600-TS	25/BOX	BLUE	#16 - #14 AWG	NA
VNBT-1200-TS	15/BOX	YELLOW	#12 - #10 AWG	NA

## SPADE (FORK) TERMINALS - TS RETAIL PACKS



PART NO	PKG	COLOR	WIRE RANGE	STUD
VNSP-2206-TS	25/BOX	RED	#22 - #18 AWG	6
VNSP-2208-TS	25/BOX	RED	#22 - #18 AWG	8
VNSP-2210-TS	25/BOX	RED	#22 - #18 AWG	10
VNSP-1606-TS	25/BOX	BLUE	#16 - #14 AWG	6
VNSP-1608-TS	25/BOX	BLUE	#16 - #14 AWG	8
VNSP-1610-TS	25/BOX	BLUE	#16 - #14 AWG	10
VNSP-1206-TS	15/BOX	YELLOW	#12 - #10 AWG	6
VNSP-1208-TS	15/BOX	YELLOW	#12 - #10 AWG	8
VNSP-1210-TS	15/BOX	YELLOW	#12 - #10 AWG	10
VNSP-1214-TS	15/BOX	YELLOW	#12 - #10 AWG	1/4"





# TS PACK SOLDERLESS TERMINALS

## SPADE (FORK) TERMINALS - TS RETAIL PACKS



PART NO	PKG	COLOR	WIRE RANGE	BLADE
VNQF-2214-TS	25/BOX	RED	#22 - #18 AWG	1/4"
VNQF-1614-TS	25/BOX	BLUE	#16 - #14 AWG	1/4"
VNQF-1214-TS	15/BOX	YELLOW	#12 - #10 AWG	1/4"
VNQM-2214-TS	25/BOX	RED	#22 - #18 AWG	1/4"
VNQM-1614-TS	25/BOX	BLUE	#16 - #14 AWG	1/4"
VNQM-1214-TS	15/BOX	YELLOW	#12 - #10 AWG	1/4"



## SOLDERLESS TERMINAL KITS



PART NO	TOTAL PCS	DESCRIPTION	INCLUDES TOOL
VNKH-0132	132	VINYL RINGS, FORKS AND BUTT SPLICES 10-22 AWG COMPACT RETAIL KIT BOX	NO
VNKH-0100	100	VINYL AND NYLON QUICK DISCONNECTS 10-22 AWG COMPACT RETAIL KIT BOX	NO
VNKH-0481	481	VINYL RINGS, FORKS AND BUTT SPLICES 10-22 AWG REUSABLE INJECTION-MOLDED CASE INCLUDES ECONOMY CRIMPER TLCR-0602	YES
VNKH-1480	480	VINYL RINGS, FORKS AND BUTT SPLICES 10-22 AWG REUSABLE INJECTION-MOLDED CASE TOOL NOT INCLUDED	NO
VNKH-2481	481	VINYL RINGS, FORKS AND BUTT SPLICES 10-22 AWG REUSABLE INJECTION-MOLDED CASE INCLUDES PREMIUM CRIMPER TLCR-0603	YES
VNKH-1200	1200	VINYL RINGS, FORKS AND BUTT SPLICES 10-22 AWG REUSABLE INJECTION-MOLDED CASE TOOL NOT INCLUDED	NO
VNKH-1200-HD	1200	VINYL RINGS, FORKS AND BUTT SPLICES 10-22 AWG REUSABLE PREMIUM STEEL CASE TOOL NOT INCLUDED	NO

# ALLIGATOR CLIPS



Alligator clips can be used in electrical or laboratory electric testing work, they are useful for connecting components to wires. Easy installation and safety for use with the insulation black red soft plastic boots coated.



PART NO	MAX OPENING	LENGTH	BOOT COLOR
ALIR-0104	1/4"	1-1/4"	RED
ALIR-0516	5/16"	1-3/8"	RED
ALIR-0716	7"	1-5/8"	RED

PART NO	MAX OPENING	LENGTH	BOOT COLOR
ALIB-0104	1/4"	1-1/4"	BLACK
ALIB-0516	5/16"	1-3/8"	BLACK
ALIB-0716	7"	1-5/8"	BLACK



## SMALL WIRE TOOLING



PART NO	MODEL	APPLICATION	DESCRIPTION
TLWS-4000	A	10-22 AWG WIRE VINYL/NYLON STANDARD BARREL	MANUAL WIRE STRIPPER AND CRIMPER WITH PATENTED CABLE TIE CUTER TIP
TLWS-2000	B	10-22 AWG WIRE VINYL/NYLON STANDARD BARREL	RAPID WIRE STRIPPER W/ ECONOMY CRIMPING NESTS
TLCR-0602	C	10-22 AWG VINYL/NYLON STANDARD BARREL	MANUAL WIRE STRIPPER AND CRIMPER
TLCR-0603	D	10-22 AWG VINYL/NYLON STANDARD BARREL	PREMIUM RATCHETING TERMINAL CRIMPER
TLPG-2000	D	8-22 AWG PIGTAIL CONNECTORS	PREMIUM RATCHETING PIGTAIL CRIMPER
TLFG-1000	D	22-14 AWG NYLON FLAG	PREMIUM RATCHETING FLAG CRIMPER
TLFG-2000	D	12-10 AG NYLON FLAG	PREMIUM RATCHETING FLAG CRIMPER
TLCR-8000	D	22-8 AWG SHRINK TERMS	PREMIUM RATCHETING SHRINK CRIMPER





# WIRE CONNECTORS

## TWIST-ON WIRE CONNECTOR



WIRE CONNECTOR

- Deep surface ridges provide better grip
- Flame retardant UL 94V-2 thermoplastic shell provides excellent electrical insulation
- Pre-twisting of wires is not necessary
- Zinc-plated springs for low contact resistance
- Temperature Rating: 105 °C (221 °F)
- Voltage: 600V max., 1,000V max. in fixtures and signs
- Wire Type: For Copper wire only

PART NO	COLOR	PACKAGING	MIN WIRE RANGE	MAX WIRE RANGE
WNGS-1000-JR	GRAY	100/JAR	#22 - #16 AWG	2 #16 AWG
WNGS-1000-ML	GRAY	1000/BAG	#22 - #16 AWG	2 #16 AWG
WNBS-1000-JR	BLUE	100/JAR	#22 - #16 AWG	3 #16 AWG
WNBS-1000-ML	BLUE	1000/BAG	#22 - #16 AWG	3 #16 AWG
WNOS-1000-JR	ORANGE	100/JAR	#22 - #14 AWG	4 #16 w/1 #20 AWG
WNOS-1000-DL	ORANGE	500/BAG	#22 - #14 AWG	4 #16 w/1 #20 AWG
WNYS-1000-JR	YELLOW	100/JAR	#18 - #10 AWG	3 #12 AWG
WNYS-1000-DL	YELLOW	500/BAG	#18 - #10 AWG	3 #12 AWG
WNRS-1000-JR	RED	100/JAR	#18 - #10 AWG	2 #10 w/2 #12 AWG
WNRS-1000-DL	RED	500/BAG	#18 - #10 AWG	2 #10 w/2 #12 AWG

## WING STYLE TWIST-ON WIRE CONNECTOR



WIRE CONNECTOR

PART NO	COLOR	PACKAGING	MIN WIRE RANGE	MAX WIRE RANGE
WNYW-1000-JR	YELLOW	100/JAR	2 #22 AWG	3 #12 AWG
WNYW-1000-DL	YELLOW	1000/BAG	2 #22 AWG	3 #12 AWG
WNTW-1000-JR	TAN	100/JAR	3 #22 AWG	3 #10 AWG
WNTW-1000-DL	TAN	1000/BAG	3 #22 AWG	3 #10 AWG
WNRW-1000-JR	RED	100/JAR	2 #20 AWG	4 #10 AWG
WNRW-1000-DL	RED	500/BAG	2 #20 AWG	4 #10 AWG
WNGW-1000-JR	GRAY	100/JAR	3 #14 AWG	1 #6 w/1 #8 AWG
WNGW-1000-QL	GRAY	250/BAG	3 #14 AWG	1 #6 w/1 #8 AWG
WNBW-1000-JR	BLUE	50/JAR	1 #10 w/1 #12 AWG	1 #6 w2 #8 AWG
WNBW-1000-QL	BLUE	250/BAG	1 #10 w/1 #12 AWG	1 #6 w2 #8 AWG

## GROUNDING TWIST-ON CONNECTOR



WIRE CONNECTOR

PART NO	COLOR	U/M	MIN WIRE RANGE	MAX WIRE RANGE
WNPW-1000-JR	GREEN	100/JAR	2 #14 AWG	4 #12 AWG
WNPW-1000-DL	GREEN	500/BAG	2 #14 AWG	4 #12 AWG



# WIRE CONNECTORS

## DIRECT BURIAL - SILICONE FILLED



WIRE CONNECTOR

- UL 486D Listed
- Suitable for all wire splices, especially those exposed to condensation, water vapors or dust
- Max. Voltage: 600V max. building wire (1000V max. signs or luminaries)
- Wire Type: For Copper wire only
- Temperature Rating: 105°C (221°F) ~ Silicone Sealant: -45°F to 400°F



PART NO	CAP COL-OR	PACKAGING	MIN WIRE RANGE	MAX WIRE RANGE
WNOD-1000	ORANGE	10/BAG	#22 AWG	#12 AWG
WNOD-1000	ORANGE	50/JAR	#22 AWG	#12 AWG
WNRD-1000	RED	10/BAG	#22 AWG	#8 AWG
WNRD-1000	RED	25/JAR	#22 AWG	#8 AWG
WNBD-1000	BLUE	10/BAG	#14 AWG	#6 AWG
WNBD-1000	BLUE	20/JAR	#14 AWG	#6 AWG

## HIGH TEMP TWIST-ON CONNECTOR



WIRE CONNECTOR

- Rated up to 302°F (150°C)
- 600V (1000V Signs and Fixtures)

PART NO	COLOR	PKG	WIRE RANGE	MIN WIRE RANGE	MAX WIRE RANGE
WNHT-1003-JR	BLACK	100/JAR	22-14	3 #20 AWG	4 #16 w/1 #20 AWG
WNHT-1004-JR	BLACK	100/JAR	18-10	1 #14 w/1 #18	4 #14 AWG

## CERAMIC HIGH TEMP TWIST-ON CONNECTOR



- Made of porcelain - rated up to 1200°F (645°C)
- Approved for circuits up to 300 V only
- For stranded copper conductor only

PART NO	PKG	WIRE RANGE	MIN WIRE RANGE	MAX WIRE RANGE
WNCM-1001-JR	100/JAR	18-14	2 #18	1 #18 w/2 #16
WNCM-1005-JR	100/JAR	18-14	2 #18	2 #18 w/2 #16
WNCM-1007-JR	100/JAR	18-16	2 #18	4 #16
WNCM-1008-JR	50/JAR	18-8	2 #14	1 #14 w/1 #16

## TWIST-ON WIRE CONNECTOR KITS



PART NO	TYPE	INCLUDED
WNKT-0158	STD WIRE CONNECTOR	GRAY, BLUE, ORANGE, YELLOW, RED
WNKT-0160	WING WIRE CONNECTOR	YELLOW, RED, GREEN, TAN, GRAY, BLUE
WNKT-0570	STD AND WING COMBO	GRAY, BLUE, ORANGE, YELLOW, RED, YELLOW, RED, GREEN, TAN, GRAY, BLUE
WNKT-0030	DIRECT BURIAL WING	ORANGE, RED, BLUE





# WIRE CONNECTORS

## STEEL CRIMP SLEEVES



- Strong, vibration resistant, permanent connections in branch circuit and wiring devices
- Copper or Zinc plated steel



PART NO	PKG	WIRE RANGE	MIN WIRE RANGE	MAX WIRE RANGE
CRZS-0410-CP	100/BOX	18-10	2 #16	2 #10 w/1 #12
CRZS-0411-BP	50/BOX	14-8	3 #12	4 #10

## COPPER CRIMP SLEEVES



PART NO	PKG	WIRE RANGE	MIN WIRE RANGE	MAX WIRE RANGE
CRCU-0310-CP	100/BOX	18-10	2 #16	2 #10 w/1 #12
CRCU-0311-CP	50/BOX	14-8	3 #12	4 #10

## WRAP CAPS



PART NO	PKG	H	W
WCAP-3410-CK	100/BOX	1.20	.625
WCAP-3411-CK	50/BOX	1.78	.750

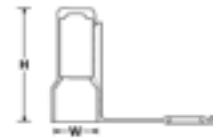

- Provide high dielectric and physical protection for use with CRZS and CRCU series crimps

## LEVER-NUT™ PUSH-IN WIRE CONNECTOR



- 2,3 and 5 port push wire connector.
- Locking mechanism assures proper connection
- For 28-12 awg, solid or stranded copper wire

PORTS	STANDARD LEVER NUT	COMPACT LEVER NUT	PKG	COLOR
2	WGLN-2412-JR	WGLC-2412-JR	100/JAR	ORANGE/GRAY
3	WGLN-3413-JR	WGLC-3413-JR	100/JAR	ORANGE/GRAY
5	WGLN-5415-JR	WGLC-5415-JR	100/JAR	ORANGE/GRAY

## PRO-TRACE® DB CONNECTOR



PRO-TRACE® DB Connector is injection molded from polycarbonate that has outstanding temperature and high-impact resistance. It is superior to breaking and cracking. The outer housing is clear in color and provides visual confidence with each installation. The inner housing features a locking mechanism made from zinc and uses applied hand pressure that securely closes and locks the wire inside with ease. A corrosion proof silicone sealant fills the inner housing and provides longevity for each installation.

- 300 Volts Max 10 AWG - 14 AWG
- Rated for Direct Burial

PART NO	PKG	PORTS	A	B
WGPT-1203	15/JAR	3	2.38"	1.38"



# PUSH-IN WIRE CONNECTORS

## PUSHWIRE CONNECTORS



- Reduce wiring time up to 50%
- No twisting, taping or crimping required, simply strip wire and push-in
- Clear housing for visual inspection
- Built-in test port for trouble shooting
- 600V (1000V Signs and Fixtures) 20A

PART NO	PKG	PORTS	COLOR	WIRE RANGE
WGYL-2162-JR	100/JAR	2	YELLOW	#12 AWG - #16 AWG
WGOR-4164-JR	100/JAR	4	ORANGE	#12 AWG - #16 AWG
WGBL-6166-JR	50/JAR	6	BLACK	#12 AWG - #16 AWG
WGDG-8108-JR	25/JAR	8	DARK GRAY	#12 AWG - #16 AWG

PART NO	PKG	PORTS	COLOR	WIRE RANGE
WGRD-3173-JR	50/JAR	3	RED	#10 AWG - #14 AWG

## Grounding Connectors for Junction Boxes, (solid and stranded wire)

PART NO	PKG	PORTS	COLOR	WIRE RANGE
WGGR-2112-JR	100/JAR	2	GREEN	#12 AWG - #16 AWG
WGGR-4114-JR	100/JAR	4	GREEN	#12 AWG - #16 AWG
WGGR-6116-JR	100/JAR	6	GREEN	#12 AWG - #16 AWG

## Pushwire Connector Kit

PART NO	PCS	DESCRIPTION
WGKT-0075	130	ASSORTED PUSHWIRE CONNECTORS
WGKT-0250	250	ASSORTED PUSHWIRE CONNECTORS LARGE
WGKT-0070	70	ASSORTED LEVER-NUT CONNECTORS

## LUMINAIRE DISCONNECTS

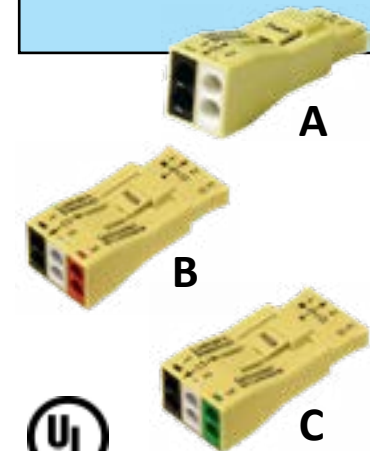

- Molded in color coding for circuit wiring: Black = L, White = N
- Automatic locking with mating of connectors, simple push down to disengage
- Copper components offers a superior connection over brass
- Completely touch-proof in the unmated position
- 100% protected against mis-mating
- 600V (1000V Signs and Fixtures) 20A
- #12 AWG - #16 AWG Copper Solid and Stranded Copper Wire

PART NO	PKG	MODEL	DESCRIPTION
WGLD-4902-JR	100/JAR	A	2 POLE
WGLD-6903-JR	100/JAR	B	3 POLE FOR SWITCHING/DIMMING
WGLD-6953-JR	100/JAR	C	3 POLE W/ GROUND CIRCUIT





# WIRE CONNECTORS

## IDC TAP CONECTORS

- Great for making quick and efficient quick splices without having to solder or strip your wires
- Commonly used in Automotive, Marine, Trailer, RV and commercial and industrial industries
- Made to meet a wide range of applications



PART NO	PKG	WIRE PATTERN	COLOR	WIRE RANGE
SLRD-2218-CL	100/BAG		RED	#22 - #18 AWG
SLBL-1614-CL	100/BAG		BLUE	#16 - #14 AWG
SLWH-1614-CL	100/BAG		WHITE	#16 - #14 AWG
SLYE-1210-CL	100/BAG		YELLOW	#12 - #10 AWG
SLBR-1216-CL	100/BAG		BROWN	#12 - #10 AWG RUN #16 - #14 AWG TAP

## IDC T-TAP CONNECTOR

- Great for making quick and efficient quick splices without having to solder or strip your wires
- Commonly used in Automotive, Marine, Trailer, RV and commercial and industrial industries
- Made to meet a wide range of applications



PART NO	PKG	COLOR	WIRE RANGE
SLTT-2218-CL	100/BAG	RED	#22 - #18 AWG
SLTT-1614-CL	100/BAG	BLUE	#16 - #14 AWG
SLTT-1210-CL	100/BAG	YELLOW	#12 - #10 AWG

## MOISTURE RESISTANT IDC CONECTORS

Create moisture resistant connections with 2 or 3 wires. Rated 1000V for use with luminaires, fixtures and signs and 600V-rated for use with building wire to meet multiple on-the-job needs. The self-stripping functionality lets you quicken installation pace to reduce labor time.



PART NO	PKG	COLOR	WIRE RANGE
IDDB-2218-JR	25/JAR	BLUE/CLEAR	#22 - #14 AWG



# WIRE FERRULES

## SINGLE WIRE FERRULES

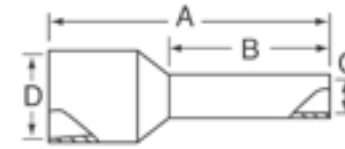

Polypropylene insulated ferrules conform to DIN standards for single and dual wire containment. Funnel entry and seamless barrel allow for faster insertion and superior terminations. Multiple pins lengths available for a variety of terminal blocks.

PART NO	PKG	CONDUCTOR SIZE	COLOR	A	B	C	D
VNFE-2606-CP	100/BOX	26 AWG	GRAY	.409	.236	.039	.059
VNFE-2406-CP	100/BOX	24 AWG	VIOLET	.409	.236	.043	.079
VNFE-2408-CP	100/BOX	24 AWG	VIOLET	.488	.315	.043	.079
VNFE-2206-CP	100/BOX	22 AWG	WHITE	.409	.236	.047	.079
VNFE-2208-CP	100/BOX	22 AWG	WHITE	.488	.315	.047	.079
VNFE-2006-CP	100/BOX	20 AWG	GRAY	.490	.236	.063	.110
VNFE-2008-CP	100/BOX	20 AWG	GRAY	.551	.315	.063	.110
VNFE-2010-CP	100/BOX	20 AWG	GRAY	.630	.394	.063	.110
VNFE-1808-CP	100/BOX	18 AWG	RED	.567	.315	.067	.110
VNFE-1810-CP	100/BOX	18 AWG	RED	.630	.394	.067	.110
VNFE-1608-CP	100/BOX	16 AWG	BLACK	.551	.315	.079	.138
VNFE-1610-CP	100/BOX	16 AWG	BLACK	.630	.394	.079	.138
VNFE-1612-CP	100/BOX	16 AWG	BLACK	.709	.472	.079	.138
VNFE-1408-CP	100/BOX	14 AWG	BLUE	.591	.315	.098	.165
VNFE-1410-CP	100/BOX	14 AWG	BLUE	.685	.394	.098	.165
VNFE-1412-CP	100/BOX	14 AWG	BLUE	.709	.472	.098	.165
VNFE-1418-CP	100/BOX	14 AWG	BLUE	.945	.709	.098	.165
VNFE-1210-CP	100/BOX	12 AWG	GRAY	.697	.394	.130	.189
VNFE-1212-CP	100/BOX	12 AWG	GRAY	.772	.472	.130	.189
VNFE-1218-CP	100/BOX	12 AWG	GRAY	1.02	.709	.130	.189
VNFE-1010-CP	100/BOX	10 AWG	YELLOW	.728	.394	.154	.248
VNFE-1012-CP	100/BOX	10 AWG	YELLOW	.787	.472	.154	.248
VNFE-1018-CP	100/BOX	10 AWG	YELLOW	1.02	.709	.154	.248
VNFE-0812-CP	50/BOX	8 AWG	RED	.866	.472	.193	.299
VNFE-0815-CP	50/BOX	8 AWG	RED	.929	.709	.193	.299

## DOUBLE WIRE FERRULES



PART NO	PKG	CONDUCTOR SIZE	COLOR	A	B	C	D
VNFD-2008-CP	100/BOX	20 AWG	GRAY	.58	.32	.08	.19
VNFD-1808-CP	100/BOX	18 AWG	RED	.60	.32	.09	.20
VNFD-1608-CP	100/BOX	16 AWG	BLACK	.61	.32	.10	.23
VNFD-1610-CP	100/BOX	16 AWG	BLACK	.69	.39	.10	.23
VNFD-1410-CP	100/BOX	14 AWG	BLUE	.73	.39	.13	.28
VNFD-1418-CP	100/BOX	14 AWG	BLUE	1.04	.71	.13	.28
VNFD-1212-CP	100/BOX	12 AWG	GRAY	.85	.47	.17	.31
VNFD-1218-CP	100/BOX	12 AWG	GRAY	1.15	.71	.17	.31
VNFD-1014-CP	100/BOX	10 AWG	YELLOW	.95	.55	.21	.41
VNFD-1018-CP	100/BOX	10 AWG	YELLOW	1.18	.71	.21	.41





# WIRE FERRULES

## NON-INSULATED FERRULES



Non-insulated ferrules conform to DIN standards for single wire containment. Funnel entry and seamless barrel allow for faster insertion and superior terminations.

PART NO	CONDUCTOR SIZE	A	B	C	PKG
NOFE-2607	26 AWG	.276	.059	.035	100/BOX
NOFE-2408	24 AWG	.315	.059	.043	100/BOX
NOFE-2208	22 AWG	.315	.082	.047	100/BOX
NOFE-2010	20 AWG	.394	.090	.059	100/BOX
NOFE-1810	18 AWG	.394	.098	.067	100/BOX
NOFE-1610	16 AWG	.394	.110	.079	100/BOX
NOFE-1412	14 AWG	.472	.130	.102	100/BOX
NOFE-1215	12 AWG	.591	.154	.130	100/BOX

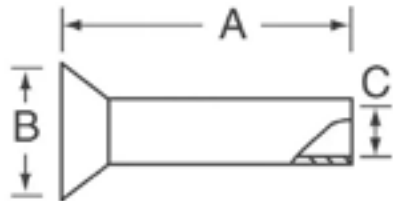

## WIRE FERRULE KITS



PART NO	TOTAL PCS	DESCRIPTION	INCLUDES TOOL
VNKF-0600	600	VINYL FERRULE KIT 600 pcs SINGLE WIRE FERRULES 22AWG - 12AWG	NO
VNKF-1301	1301	VINYL FERRULE KIT 1300pcs SINGLE WIRE FERRULES 22AWG - 12AWG TWIN WIRE FERRULES 22AWG - 14 AWG INCLUDES TOOL: TLFE-2410	YES
VNKF-2301	1301	VINYL FERRULE KIT 1300pcs SINGLE WIRE FERRULES 22AWG - 12AWG TWIN WIRE FERRULES 22AWG - 14 AWG INCLUDES TOOL: TLFE-2810	YES

## WIRE FERRULE TOOLS

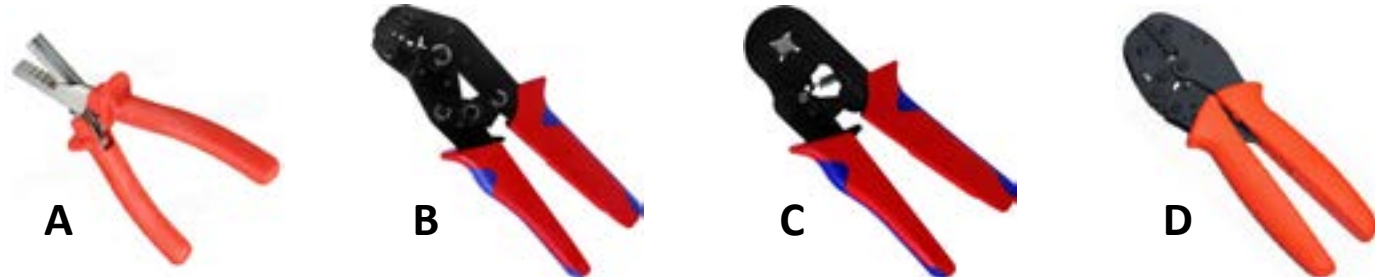

PART NO	MODEL	WIRE SIZE	CRIMP PROFILE	CRIMP STYLE	MECHANISM
TLFE-1610	A	16-10 AWG	HALF-MOON	COMPRESSION	MANUAL
TLFE-2410	B	24-10 AWG	TRAPEZOIDAL	COMPRESSION	RATCHET
TLFE-2810	C	28-10 AWG	SQUARE	4 POINT	RATCHET
TLFE-2208	D	22-8 AWG	TRAPEZOIDAL	COMPRESSION	RATCHET



# TERMINAL STRIPS

## BARRIER STRIPS - DOUBLE ROW

- Surface mount, sub-panel, chassis connection
- Self-extinguishing
- Resist breakage
- No. 6-32 external twin screws
- 22 AWG to 10 AWG
- Economical closed-back design (no need for costly insulation strip)
- Rated for 300V/30A

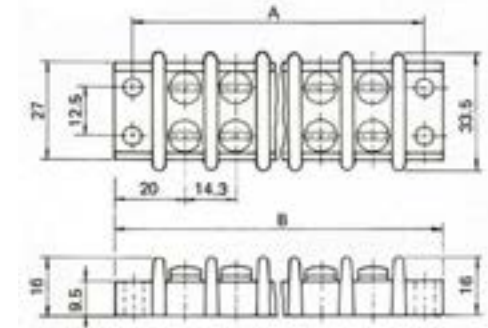

PART NO	PITCH	Poles	A	B
TBST-1402-EA	.5625	2	1.69	2.13
TBST-1403-EA	.5625	3	2.25	2.69
TBST-1404-EA	.5625	4	2.81	3.26
TBST-1405-EA	.5625	5	3.38	3.82
TBST-1406-EA	.5625	6	3.94	4.38
TBST-1408-EA	.5625	8	5.06	5.50
TBST-1410-EA	.5625	10	6.19	6.63
TBST-1412-EA	.5625	12	7.31	7.75

All wire sizes, unless noted otherwise, are American Wire Gauge (AWG)

## EURO STYLE - TOUCH SAFE

The panel and chassis mounted series are ideal for connecting electrical control panels to external power sources, signal sources, other electrical panels and electrical loads of many types and sizes. Ideal for use with wire ferrules, the screw tightened connections result in high contact forces thus promoting safe wire secureness and retention, low electrical resistance and safe reusable connections. All wire retention screws are captive in their towers and they cannot fall out during transportation, installation and use.

- No exposed contacts for safe
- Housing Material: Polyamide 66 (Nylon 66), UL 94V-2
- Temperature Rating: 105°C (UL), -30°C to 110°C (VDE)
- Terminal Insert: Brass metal alloy, nickel plated
- Screw: Zinc plated



PART NO	WIRE SIZE	PITCH	POLES	AMPS
TBUT-1402-EA	20-12 AWG	.30	12	20A
TBUT-1403-EA	20-14 AWG	.30	12	15A
TBUT-1404-EA	18-10 AWG	.40	12	30A
TBUT-1405-EA	18-12 AWG	.40	12	20A
TBUT-1406-EA	14-8 AWG	.45	12	50A
TBUT-1408-EA	14-10 AWG	.45	12	30A

All wire sizes, unless noted otherwise, are American Wire Gauge (AWG)



# WIRE IDENTIFICATION



## WIRE MARKER BOOKS



Posi-tech pre-printed wire marker book is compact, easy to carry, and easy to use. Each wire marker book includes 10 pages of wire markers constructed of highest quality vinyl-coated cloth, backed with high-tack rubber adhesive. Each wire marker includes a matching terminal marker.

- Pre-printed vinyl coated cloth wire markers
- High-tack rubber adhesive
- Convenient 10-page booklets

PART NO	LEGEND	MARKERS PER BOOK
BKWM-4510	1-45	10 EA
BKWM-0945	0-9	45 EA
BKWM-4690	46-90	10 EA
BKWM-AZ10	A-Z, 0-15, +, -, /	10 EA
BKWM-1001	1" X 2-1/2" WRITE-ON BLANKS	60 EA
BKWM-1002	1" X 5" WRITE-ON BLANKS	30 EA

## VOLTAGE MARKER LABELS - SELF ADHESIVE



Use Posi-tech's black on orange self-adhesive voltage markers to identify voltages on conduit, power and distribution panels, electrical components, and control panels. Constructed of vinyl with permanent acrylic adhesive, these voltage markers resist abrasion, dirt, oil, grease, moisture, and most chemicals and solvents.

LEGEND	STYLE A 1 MARKER PER CARD 2-1/4" X 9"	STYLE B 4 MARKERS PER CARD 1-1/8" X 4-1/2"	STYLE C 18 MARKERS PER CARD 1-1/8" X 4-1/2"	QTY/PACK
120V	LBLA-0120	LBLB-0120	LBLC-0120	5
208V	LBLA-0208	LBLB-0208	LBLC-0208	5
220V	LBLA-0220	LBLB-0220	LBLC-0220	5
240V	LBLA-0240	LBLB-0240	LBLC-0240	5
277V	LBLA-0277	LBLB-0277	LBLC-0277	5
480V	LBLA-0480	LBLB-0480	LBLC-0480	5
120v/240v	LBLA-1224	LBLB-1224	LBLC-1224	5
120v/208v	LBLA-1228	LBLB-1228	LBLC-1228	5
277v/480v	LBLA-2748	LBLB-2748	LBLC-2748	5
4160V	LBLA-4160	LBLB-4160	LBLC-4160	5



# SIGNS AND LABELS



## HIGH-VOLTAGE, AUTHORIZED PERSONNEL

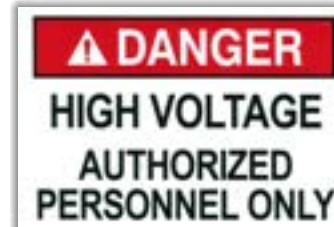

PART NO	SIZE	QTY/PACK
LBEL-0355-HVA	3.5" X 5"	5
LBEL-0710-HVA	7" X 10"	2
LBEL-1014-HVA	10" X 14"	EACH

## DANGER, ARC FLASH HAZARD



PART NO	SIZE	QTY/PACK
LBEL-0355-AF	3.5" X 5"	5
LBEL-0710-AF	7" X 10"	2
LBEL-1014-AF	10" X 14"	EACH

## DANGER, HIGH VOLTAGE



PART NO	SIZE	QTY/PACK
LBEL-0355-DHV	3.5" X 5"	5
LBEL-0710-DHV	7" X 10"	2
LBEL-1014-DHV	10" X 14"	EACH

## WARNING, LIVE ELECTRIC



PART NO	SIZE	QTY/PACK
LBEL-0355-WLE	3.5" X 5"	5
LBEL-0710-WLE	7" X 10"	2
LBEL-1014-WLE	10" X 14"	EACH

## DANGER, HIGH VOLTAGE, KEEP OUT



PART NO	SIZE	QTY/PACK
LBEL-0355-HVK	3.5" X 5"	5
LBEL-0710-HVK	7" X 10"	2
LBEL-1014-HVK	10" X 14"	EACH





# CABLE TIES



# CABLE TIES



## NATURAL CABLE TIES

Python Wraps are manufactured to be superior in strength, far exceeding the required tensile strengths used in industry standards. Using high quality raw materials, we are proud of our ties and back them up with a 100% guarantee.

Select ties (noted below) are designed to meet all the testing requirements of Aerospace Standard SAE-AS23190A (formerly MIL-S-23190) and the dimensional requirements of Aerospace Standard SAE-AS33671 (formerly MS3367).

PART NO	MIL SPEC	PACK	COLOR	LENGTH	TENSILE	WIDTH
CTSN-0418	MS3367-4-0	100/BAG	NATURAL	4.12	18LBS	.095
CTSN-0418-ML	MS3367-4-0	1000/BAG	NATURAL	4.12	18LBS	.095
CTSN-0818	N/A	100/BAG	NATURAL	8.18	18LBS	.095
CTSN-0818-ML	N/A	1000/BAG	NATURAL	8.18	18LBS	.095

PART NO	MIL SPEC	PACK	COLOR	LENGTH	TENSILE	WIDTH
CTSN-0540	AL-05-40-0	100/BAG	NATURAL	5.84	40LBS	.140
CTSN-0540-ML	AL-05-40-0	1000/BAG	NATURAL	5.84	40LBS	.140
CTSN-0840	N/A	100/BAG	NATURAL	8.89	40LBS	.140
CTSN-0840-ML	N/A	1000/BAG	NATURAL	8.89	40LBS	.140

PART NO	MIL SPEC	PACK	COLOR	LENGTH	TENSILE	WIDTH
CTSN-0750	MS3367-1-0	100/BAG	NATURAL	7.56	50LBS	.180
CTSN-0750-ML	MS3367-1-0	1000/BAG	NATURAL	7.56	50LBS	.180
CTSN-1150	MS3367-7-0	100/BAG	NATURAL	11.25	50LBS	.180
CTSN-1150-DL	MS3367-7-0	500/BAG	NATURAL	11.25	50LBS	.180
CTSN-1450	MS3367-2-0	100/BAG	NATURAL	14.25	50LBS	.180
CTSN-1450-DL	MS3367-2-0	500/BAG	NATURAL	14.25	50LBS	.180

PART NO	MIL SPEC	PACK	COLOR	LENGTH	TENSILE	WIDTH
CTSN-0812		100/BAG	NATURAL	8.70	120LBS	.302
CTSN-1412	MS3367-3-0	100/BAG	NATURAL	15.09	120LBS	.302
CTSN-1812	N/A	50/BAG	NATURAL	18.43	120LBS	.302
CTSN-2412	N/A	50/BAG	NATURAL	24.43	120LBS	.302
CTSN-3012	MS3367-6-0	50/BAG	NATURAL	30.75	120LBS	.302

PART NO	MIL SPEC	PACK	COLOR	LENGTH	TENSILE	WIDTH
CTSN-2417	MS3367-10-0	50/BAG	NATURAL	25.25	175LBS	.340
CTSN-3617	MS3367-13-0	50/BAG	NATURAL	37.25	175LBS	.340
CTSN-4817	MS3367-16-0	50/BAG	NATURAL	48.50	175LBS	.340

PART NO	MIL SPEC	PACK	COLOR	LENGTH	TENSILE	WIDTH
CTSN-2225	N/A	100/BAG	NATURAL	21.93	250LBS	.494



## UV BLACK CABLE TIES

Python Wraps are manufactured to be superior in strength, far exceeding the required tensile strengths used in industry standards. Using high quality raw materials, we are proud of our ties and back them up with a 100% guarantee.

Select ties (noted below) are designed to meet all the testing requirements of Aerospace Standard SAE-AS23190A (formerly MIL-S-23190) and the dimensional requirements of Aerospace Standard SAE-AS33671 (formerly MS3367).

PART NO	MIL SPEC	PACK	COLOR	LENGTH	TENSILE	WIDTH
CTSB-0418	MS3367-4-0	100/BAG	BLACK	4.12	18LBS	.095
CTSB-0418-ML	MS3367-4-0	1000/BAG	BLACK	4.12	18LBS	.095
CTSB-0818	N/A	100/BAG	BLACK	8.18	18LBS	.095
CTSB-0818-ML	N/A	1000/BAG	BLACK	8.18	18LBS	.095

PART NO	MIL SPEC	PACK	COLOR	LENGTH	TENSILE	WIDTH
CTSB-0540	AL-05-40-0	100/BAG	BLACK	5.84	40LBS	.140
CTSB-0540-ML	AL-05-40-0	1000/BAG	BLACK	5.84	40LBS	.140
CTSB-0840	N/A	100/BAG	BLACK	8.89	40LBS	.140
CTSB-0840-ML	N/A	1000/BAG	BLACK	8.89	40LBS	.140

PART NO	MIL SPEC	PACK	COLOR	LENGTH	TENSILE	WIDTH
CTSB-0750	MS3367-1-0	100/BAG	BLACK	7.56	50LBS	.180
CTSB-0750-ML	MS3367-1-0	1000/BAG	BLACK	7.56	50LBS	.180
CTSB-1150	MS3367-7-0	100/BAG	BLACK	11.25	50LBS	.180
CTSB-1150-DL	MS3367-7-0	500/BAG	BLACK	11.25	50LBS	.180
CTSB-1450	MS3367-2-0	100/BAG	BLACK	14.25	50LBS	.180
CTSB-1450-DL	MS3367-2-0	500/BAG	BLACK	14.25	50LBS	.180

PART NO	MIL SPEC	PACK	COLOR	LENGTH	TENSILE	WIDTH
CTSB-0812		100/BAG	BLACK	8.70	120LBS	.302
CTSB-1412	MS3367-3-0	100/BAG	BLACK	15.09	120LBS	.302
CTSB-1812	N/A	50/BAG	BLACK	18.43	120LBS	.302
CTSB-2412	N/A	50/BAG	BLACK	24.43	120LBS	.302
CTSB-3012	MS3367-6-0	50/BAG	BLACK	30.75	120LBS	.302

PART NO	MIL SPEC	PACK	COLOR	LENGTH	TENSILE	WIDTH
CTSB-2417	MS3367-10-0	50/BAG	BLACK	25.25	175LBS	.340
CTSB-3617	MS3367-13-0	50/BAG	BLACK	37.25	175LBS	.340
CTSB-4817	MS3367-16-0	50/BAG	BLACK	48.50	175LBS	.340

PART NO	MIL SPEC	PACK	COLOR	LENGTH	TENSILE	WIDTH
CTSB-2225	N/A	100/BAG	BLACK	21.93	250LBS	.494





# CABLE TIES



## AIR HANDLING TIES FOR PLENUM SPACES



- Ideal for air handling spaces above drop ceilings and below raised flooring
- Meets UL 62275 low smoke generation, low heat release, and mechanical strength test



PART NO	PACK	COLOR	LENGTH	TENSILE	WIDTH
CTSZ-0850	100/BAG	BURGANDY	7.56	50LB	.180
CTSZ-1150	100/BAG	BURGANDY	11.25	50LB	.180
CTSZ-1450	100/BAG	BURGANDY	14.56	50LB	.180

## IDENTIFICATION TIES



PART NO	PACK	COLOR	LENGTH	TENSILE	WIDTH
CTID-0418	100/BAG	NATURAL	4.0	18Lbs	.100
CTID-0750	100/BAG	NATURAL	7.8	50Lbs	.181

## MOUNTING TIES



PART NO	PACK	COLOR	LENGTH	TENSILE	WIDTH
CTMN-0530	100/BAG	NATURAL	5.8	30Lbs	.138
CTMN-0750	100/BAG	NATURAL	8.0	50Lbs	.177
CTMN-1150	100/BAG	NATURAL	11.5	50Lbs	.177
CTMN-1450	100/BAG	NATURAL	14.5	50Lbs	.177

PART NO	PACK	COLOR	LENGTH	TENSILE	WIDTH
CTMB-0530	100/BAG	BLACK	5.8	30Lbs	.138
CTMB-0750	100/BAG	BLACK	8.0	50Lbs	.177
CTMB-1150	100/BAG	BLACK	11.5	50Lbs	.177
CTMB-1450	100/BAG	BLACK	14.5	50Lbs	.177

## CABLE TIE REMOVAL TOOL / WIRE STRIPPER



The TLWS-4000 includes a built in 12-22 AWG wire stripper. Designed for safely cutting cable ties off of bundles of wires. Using the wrong tool such as a pair of side cutters can result in wire damage or even severing the wire. Perfect for working in tight places such as behind patch panels, A/V systems, or other head end equipment. Also perfect for cutting off cable tie tails flush; eliminate sharp dangerous edges on your cable ties. Features: Fits All Cable Tie Sizes Scissor Action Cutters Safety Guard Ensures Bundle Protection High Quality Heat Treated Alloy Steel Auto Return Spring Handles Handle Lock for Storage Ergonomic Cushion Grip Handles Professional Quality MADE IN THE USA

PART NO	DESCRIPTION
TLWS-4000	CUTTER/STRIPPER



# CABLE TIES



## ADHESIVE BACKED MOUNTING BASES



- Saves cable tie cinching time
- Easy insertion of cable ties
- Saves positioning time

PART NO	PACK	COLOR	LENGTH	SLOT	WIDTH
CTMT-0007	100/BAG	NATURAL	.75	.20 50LB	.75
CTMT-0010	100/BAG	NATURAL	1.00	.20 50LB	1.00
CTMT-0015	100/BAG	NATURAL	1.50	.30 120LB	1.50

PART NO	PACK	COLOR	LENGTH	TENSILE	WIDTH
CTMB-0007	100/BAG	BLACK	.75	.20 50LB	.75
CTMB-0010	100/BAG	BLACK	1.00	.20 50LB	1.00
CTMB-0015	100/BAG	BLACK	1.50	.30 120LB	1.50

## SADDLE STYLE MOUNTING BASES



- Deep cradle design provides maximum support for larger bundles and tubing
- Recessed screw hole allows cable ties to easily pass over screw head
- Non-Adhesive

PART NO	PACK	COLOR	LENGTH	SLOT	WIDTH
CTMB-0619	100/BAG	BLACK	.62	.19 50LB	.37
CTMB-1230	100/BAG	BLACK	.87	.30 120LB	.64
CTMB-1235	100/BAG	BLACK	.90	.35 175LB	.63

## SIDE LASH MOUNTING BASES FOR HD TIES



- For use with heavy duty cable ties to provide maximum support for large and/or heavy bundles
- Slanted slot allows cable tie to be easily inserted over the bolts
- Easily add or remove bundled items while leaving screw mount in place
- Non-Adhesive

PART NO	PACK	COLOR	LENGTH	SLOT	WIDTH
CTMB-1230	100/BAG	BLACK	.87	.30 120LB	.64
CTMB-1235	100/BAG	BLACK	.90	.35 175LB	.63

## ANCHOR MOUNT BASE



- Save positioning time with 4 sided entry allowing parallel or perpendicular bundle alignment
- Used in confined spaces & control panels and other areas where space is limited
- Quickly secures and positions wire bundles, cables, and hoses to panels
- Easy insertion of cable ties through wide entry slot
- Non-Adhesive

PART NO	PACK	COLOR	LENGTH	SLOT	WIDTH
CTMB-0619	100/BAG	NATURAL	.62	.20 50LB	.39





# CABLE TIES



## COLOR CABLE TIES



PART NO	PACK	COLOR	LENGTH	TENSILE	WIDTH
CTSW-0540	100/BAG	BROWN	5.84	40LB	.140
CTSR-0540	100/BAG	RED	5.84	40LB	.140
CTSO-0540	100/BAG	ORANGE	5.84	40LB	.140
CTSY-0540	100/BAG	YELLOW	5.84	40LB	.140
CTSG-0540	100/BAG	GREEN	5.84	40LB	.140
CTSL-0540	100/BAG	BLUE	5.84	40LB	.140
CTSA-0540	100/BAG	GRAY	5.84	40LB	.140
CTSP-0540	100/BAG	PURPLE	5.84	40LB	.140

PART NO	PACK	COLOR	LENGTH	TENSILE	WIDTH
CTSW-0840	100/BAG	BROWN	8.89	40LB	.140
CTSR-0840	100/BAG	RED	8.89	40LB	.140
CTSO-0840	100/BAG	ORANGE	8.89	40LB	.140
CTSY-0840	100/BAG	YELLOW	8.89	40LB	.140
CTSG-0840	100/BAG	GREEN	8.89	40LB	.140
CTSL-0840	100/BAG	BLUE	8.89	40LB	.140
CTSA-0840	100/BAG	GRAY	8.89	40LB	.140
CTSP-0840	100/BAG	PURPLE	8.89	40LB	.140

PART NO	PACK	COLOR	LENGTH	TENSILE	WIDTH
CTSW-1150	100/BAG	BROWN	11.25	50LB	.180
CTSR-1150	100/BAG	RED	11.25	50LB	.180
CTSO-1150	100/BAG	ORANGE	11.25	50LB	.180
CTSY-1150	100/BAG	YELLOW	11.25	50LB	.180
CTSG-1150	100/BAG	GREEN	11.25	50LB	.180
CTSL-1150	100/BAG	BLUE	11.25	50LB	.180
CTSA-1150	100/BAG	GRAY	11.25	50LB	.180
CTSP-1150	100/BAG	PURPLE	11.25	50LB	.180

## CABLE TIE TENSIONING TOOLS



PART NO	DESCRIPTION	FOR USE WITH
TLCT-1000	ECONOMY (PLASTIC)	181b - 501b TIES
TLCT-2000	PREMIUM GUN STYLE	181b - 501b TIES
TLCT-3000	HEAVY DUTY	1201b - 1751b TIES



# CABLE TIES



## 316 STAINLESS STEEL CABLE TIES



- Temperature Rating: 1000 °F (500 °C)
- Provides high resistance to heat, salts and acids
- Perfect for outdoor and underground applications

PART NO	PACK	COLOR	LENGTH	TENSILE	WIDTH
CTSS-0610	100/BAG	NA	5.90	100LB	.181
CTSS-0810	100/BAG	NA	7.87	100LB	.181
CTSS-1410	100/BAG	NA	14.17	100LB	.181
CTSS-2010	100/BAG	NA	20.47	100LB	.181
CTSS-2710	100/BAG	NA	26.77	100LB	.181

PART NO	PACK	COLOR	LENGTH	TENSILE	WIDTH
CTSS-0625	100/BAG	NA	5.90	250LB	.311
CTSS-0825	100/BAG	NA	7.87	250LB	.311
CTSS-1425	100/BAG	NA	14.17	250LB	.311
CTSS-2025	100/BAG	NA	20.47	250LB	.311
CTSS-2725	100/BAG	NA	26.77	250LB	.311

## STAINLESS CABLE TIE TENSIONING TOOL



- Aluminum alloy construction
- Ergonomic design for comfort
- Adjustable tension screw - 4 levels with Automatic cutter

PART NO	DESCRIPTION	FOR USE WITH
TLCT-4000	SS TIE GUN	1001b TIES
TLCT-5000	SS TIE GUN	100 - 2501b TIES

## HOOK AND LOOP



Made of polyethylene hooks and nylon loops, Hook and Loop fasteners can be opened and closed thousands of times and are easily refastened. The hook loop cable ties are used for an array of jobs found everywhere wires, cable and cords run.

PART NO	PACK	COLOR	LENGTH	WIDTH
CTVB-0400	100	BLACK	4"	1/2"
CTVB-0800	100	BLACK	8"	1/2"
CTVB-1200	100	BLACK	12"	1/2"





# CABLE MANAGEMENT



## NYLON CABLE CLAMPS



- Secure cables, harnesses and hoses
- Radius edges prevents cutting and abrasion from clamp

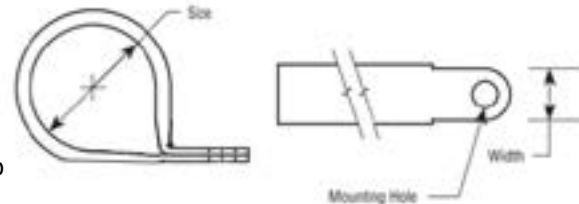

DIAMETER	NATURAL	BLACK	PKG	COLOR	SCREW HOLE	WIDTH
.126	CCSW-0125	CCSB-0125	100/BAG	NATURAL	.181	.378
.189	CCSW-0187	CCSB-0187	100/BAG	NATURAL	.181	.378
.250	CCSW-0250	CCSB-0250	100/BAG	NATURAL	.181	.394
.311	CCSW-0312	CCSB-0312	100/BAG	NATURAL	.181	.394
.374	CCSW-0375	CCSB-0375	100/BAG	NATURAL	.181	.472
.500	CCSW-0500	CCSB-0500	100/BAG	NATURAL	.181	.472
.622	CCSW-0625	CCSB-0625	100/BAG	NATURAL	.181	.472
.764	CCSW-0750	CCSB-0750	100/BAG	NATURAL	.181	.472
1.00	CCSW-1000	CCSB-1000	100/BAG	NATURAL	.181	.472
1.25	CCSW-1250	CCSB-1250	100/BAG	NATURAL	.181	.472
1.45	CCSW-1500	CCSB-1500	100/BAG	NATURAL	.181	.472

## EPDM CUSHIONED CLAMP



- Light to medium-duty clamp
- E.P.D.M. cushion for electrical insulation and vibration absorption

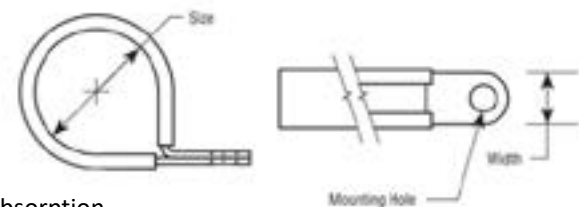

SIZE	STEEL	304 STAINLESS	PKG	MOUNTING HOLE	WIDTH
1/4"	CSRB-0250	C2RB-0250	100	.281	1/2"
3/8"	CSRB-0375	C2RB-0375	100	.281	1/2"
1/2"	CSRB-0500	C2RB-0500	100	.281	1/2"
3/4"	CSRB-0750	C2RB-0750	100	.281	1/2"
1"	CSRB-1000	C2RB-1000	50	.281	1/2"
1-1/4"	CSRB-1250	C2RB-1250	50	.281	1/2"
1-1/2"	CSRB-1500	C2RB-1500	50	.281	1/2"
2"	CSRB-2000	C2RB-2000	25	.281	1/2"
2-1/2"	CSRB-2500	C2RB-2500	25	.281	1/2"
3"	CSRB-3000	C2RB-3000	25	.281	1/2"
4"	CSRB-4000	C2RB-4000	10	.281	1/2"



# CABLE MANAGEMENT



## SPIRAL HARNESS WRAP



NATURAL



BLACK

PART NO	ID	BUNDLE SIZE	PACK
SHPN-0125	.125	.063 - .500	100FT
SHPN-0187	.187	.125 - 1.50	100FT
SHPN-0250	.250	.188 - 2.00	100FT
SHPN-0375	.375	.313 - 3.00	100FT
SHPN-0500	.500	.375 - 4.00	100FT
SHPN-0625	.625	.625 - 4.50	100FT
SHPN-0750	.750	.750 - 5.00	100FT
SHPN-1000	1.00	1.00 - 7.00	100FT

PART NO	ID	BUNDLE SIZE	PACK
SHPB-0125	.125	.063 - .500	100FT
SHPB-0187	.187	.125 - 1.50	100FT
SHPB-0250	.250	.188 - 2.00	100FT
SHPB-0375	.375	.313 - 3.00	100FT
SHPB-0500	.500	.375 - 4.00	100FT
SHPB-0625	.625	.625 - 4.50	100FT
SHPB-0750	.750	.750 - 5.00	100FT
SHPB-1000	1.00	1.00 - 7.00	100FT

## SPLIT LOOM



High quality polyethylene split tubing is ideal for a wide range of applications including automotive, marine and industrial. Resistant to abrasions, gasoline, oil, and other harmful chemicals. Operating range of -40° to 200°F (-40°C to 93°C)

PART NO	DIAMETER	LENGTH	COLOR
LOSB-0104	1/4"	100FT	BLACK
LOSB-0308	3/8"	100FT	BLACK
LOSB-0102	1/2"	100FT	BLACK
LOSB-0304	3/4"	100FT	BLACK
LOSB-1000	1"	50FT	BLACK

## EXPANDABLE BRAIDED SLEEVING



Our expandable braided sleeving is a braided weave with a wide expandability that enables quick n' easy installation over large connectors and lengthy runs. This sleeving is braided from 10 mil polyethylene terephthalate (PET) monofilament yarns. The material has a wide operating temperature range (-94°F to +125°F), is resistant to chemical degradation, UV radiation, and abrasion. The sleeving cuts easily and cleanly with a hot knife and once installed, will beautify and protect any wire, hose or cable application.

PART NO	NOM SIZE	MIN	MAX	LENGTH	COLOR
BSBK-0104	1/4"	3/16"	7/16"	100FT	BLACK
BSBK-0308	3/8"	1/4"	1/2"	100FT	BLACK
BSBK-0102	1/2"	3/8"	3/4"	75FT	BLACK
BSBK-0304	3/4"	3/4"	1-1/4"	50FT	BLACK
BSBK-1000	1"	1"	1-5/8"	40FT	BLACK





# PYTHON SHRINK™



## THIN WALL POLYOLEFIN 2:1 SHRINK TUBING



Flexible, multi-purpose heat shrinkable tubing

- Flame retardant (colours only)
- Resistant to common fluids and solvents
- Economical mechanical protection for terminal strain relief and wire bundling
- Continuous operating temperature: -55°C to 135°C
- Standard colors: Black, Red, White, Clear, Blue, Yellow & Green
- Shrink Temperature 90°C

### O Type - 2:1 shrink ratio

PART NO	NOM SIZE BEFORE SHRINK	APPROXIMATE CABLE SIZE*	ID BEFORE SHRINK	ID RECOVERED	WALL THICKNESS RECOVERED	FLAT WIDTH BEFORE SHRINK**
STOB-0364	3/64"	#36 AWG - #28 AWG	.0468	.023	.016	.07
STOB-0116	1/16"	#26 AWG - #20 AWG	.0625	.031	.017	.10
STOB-0332	3/32"	#28 AWG - #22 AWG	.0938	.046	.020	.15
STOB-0108	1/8"	#22 AWG - #16 AWG	.125	.062	.020	.20
STOB-0316	3/16"	#16 AWG - #10 AWG	.187	.093	.020	.29
STOB-0104	1/4"	#12 AWG - #8 AWG	.250	.125	.025	.39
STOB-0308	3/8"	#8 AWG - #4 AWG	.375	.187	.025	.59
STOB-0102	1/2"	#4 AWG - 1/0 AWG	.500	.250	.025	.79
STOB-0508	5/8"	#4 AWG - 4/0 AWG	.625	.315	.030	.98
STOB-0304	3/4"	#2 AWG - 300 MCM	.750	.375	.030	1.18
STOB-1000	1"	2/0 AWG - 400 MCM	1.00	.500	.035	1.57
STOB-1250	1-1/4"	250 MCM - 600 MCM	1.125	.630	.035	1.96
STOB-1500	1-1/2"	350 MCM - 900 MCM	1.50	.750	.040	2.36
STOB-2000	2"	500 MCM - 2000 MCM	2.00	1.00	.045	3.14
STOB-3000	3"	1500 MCM - 2000 MCM	3.00	1.50	.050	4.71
STOB-4000	4"	-----	4.00	2.00	.055	6.28

\* Cable size listed is approximated based on THHN/TFFN/ OD specifications. Please consult Appendix A (page 176) or your wire manufacturer for proper fitment. Terminations and splices are not calculated in this application guide.

\*\* Flat measurement is the width of material when flattened. This is for identification only and not suitable for application suitability.

### Ordering Options



Color Ordering Options: STO\_ (B-Black, W-White, R-Red, C-Clear, L-Blue, Y-Yellow, G-Green)

Cut Options: Add suffix (examples STOB-0104-CR) FT - 1ft Cuts  
4F - 4ft Sticks  
CR - 100ft Reel



# PYTHON SHRINK™



## DUAL WALL POLYOLEFIN 3:1 SHRINK TUBING FOR WET APPLICATIONS

Adhesive-lined heat shrink tubing ideal for applications where both exceptional flame retardancy and environmental sealing capabilities are required. Ideal for wet applications such as well pumps, waste treatment and aquatic features.

- Flame retardant
- Superior sealing against water, moisture or other contaminants
- Meets MIL - DTL - 23053/4
- Class 3
- Continuous Operating Temperature: -55°C to 125°C
- Shrink Temperature: 120°C



### S Type - 3:1 shrink ratio

PART NO	NOM SIZE BEFORE SHRINK	APPROXIMATE CABLE SIZE*	ID BEFORE SHRINK	ID RECOVERED	WALL THICKNESS RECOVERED
STSB-0108	1/8"	#28 AWG - #16 AWG	.125	.040	.020
STSB-0316	3/16"	#24 AWG - #10 AWG	.187	.060	.020
STSB-0104	1/4"	#20 AWG - #8 AWG	.250	.080	.025
STSB-0308	3/8"	#18 AWG - #4 AWG	.375	.100	.025
STSB-0102	1/2"	#16 AWG - 1/0 AWG	.500	.125	.025
STSB-0304	3/4"	#8 AWG - 1/0 AWG	.750	.250	.030
STSB-1000	1"	#2 - 3/0 AWG	1.00	.320	.035
STSB-1250	1-1/4"	2/0 AWG - 250 MCM	1.125	.416	.035
STSB-1500	1-1/2"	3/0 AWG - 400 MCM	1.50	.510	.040

\* Cable size listed is approximated based on THHN/TFFN/ OD specifications. Please consult Appendix A (page 176) or your wire manufacturer for proper fitment. Terminations and splices are not calculated in this application guide.

### Ordering Options



Color Ordering Options: STS\_ (B-Black, R-Red, W-White, C-Clear)

Cut Options: Add suffix (examples STSB-0104-FT) FT - 1ft Cuts  
4F - 4ft Sticks





# PYTHON SHRINK™



## HEAVY WALL POLYOLEFIN 3:1 SHRINK TUBING FOR DIRECT BURIAL APPLICATIONS



Heavy wall heat shrink tubing insulates and protects electrical splices and terminations where maximum flame retardancy and exceptional insulating and sealing characteristics are required.

- Thermoplastic adhesive liner provides complete environmental protection and insulation • Flame retardant
- High impact and abrasion resistance - capable of withstanding severe mechanical abuse of URD and direct burial installations.
- Rated for 1 kV, 90°C continuous use
- Continuous Operating Temperature: -55°C to 110°C
- UL 486D (except where noted)
- Shrink Temperature: 120°C

### A Type - 3:1 shrink ratio



PART NO	NOM SIZE BEFORE SHRINK	APPROXIMATE CABLE SIZE*	ID BEFORE SHRINK	ID RECOVERED	WALL THICKNESS RECOVERED
STAB-0300	1/4"	#14 AWG - #8 AWG	.300	.10	.06
STAB-0400	3/8"	#12 AWG - #6 AWG	.400	.15	.06
STAB-0102	1/2"	#10 AWG - #3 AWG	.500	.16	.08
STAB-0304	3/4"	#8 AWG - 1/0 AWG	.750	.22	.09
STAB-1000	1.1"	#2 - 4/0 AWG	1.10	.35	.12
STAB-1500	1-1/2"	3/0 AWG - 400 MCM	1.50	.47	.16
STAB-2000	2"	250 MCM - 750 MCM	2.00	.63	.16
STAB-2700	2.7"	600 - 1250 MCM	2.70	.87	.16
STAB-3500	3-1/2"	1500 - 2000 MCM	3.54	1.18	.16
STAB-4700	4.7"	NA	4.72	1.57	.17

\* Cable size listed is approximated based on THHN/TFFN/ OD specifications. Please consult Appendix A (page 176) or your wire manufacturer for proper fitment. Terminations and splices are not calculated in this application guide.

## Ordering Options

Color Ordering Options: STA\_ (B-Black, R-Red)



Cut Options: Add suffix (examples STAB-0102-FT) FT - 1ft Cuts  
4F - 4ft Sticks



# PYTHON SHRINK™



## HEAT SHRINK ASSORTMENT KITS

PART NO	SIZES	TYPE
STKT-9400	(25) 1/8" (25) 3/16" (20) 1/4" (12) 3/8" (7) 1/2" (5) 3/4"	<b>BLACK</b> O TYPE
STKT-9401	(25) 1/8" (25) 3/16" (20) 1/4" (12) 3/8" (7) 1/2" (5) 3/4"	MIXED <b>COLORS</b> O TYPE
STKT-9402	(25) 1/8" (25) 3/16" (20) 1/4" (12) 3/8" (7) 1/2" (5) 3/4"	<b>BLACK</b> S TYPE
STKT-9403	(25) 1/8" (25) 3/16" (20) 1/4" (12) 3/8" (7) 1/2" (5) 3/4"	<b>BLACK AND RED</b> S TYPE

- 94 total pcs
- 6" pieces
- Molded clear polypropylene case



## HEAT SHRINK TS RETAIL PACKS

- 6" pieces
- Fixed pricing across all sizes and colors
- Retail packaging designed for peghook display

### 3:1 - S Type - Dual Wall for Wet Applications

SIZE	PCS BAG	BLACK	RED	CLEAR	WHITE
1/8"	15	STSB-0108-TS	STSR-0108-TS	STSC-0108-TS	STSW-0108-TS
3/16"	15	STSB-0316-TS	STSR-0316-TS	STSC-0316-TS	STSW-0316-TS
1/4"	15	STSB-0104-TS	STSR-0104-TS	STSC-0104-TS	STSW-0104-TS
3/8"	12	STSB-0308-TS	STSR-0308-TS	STSC-0308-TS	STSW-0308-TS
1/2"	10	STSB-0102-TS	STSR-0102-TS	STSC-0102-TS	STSW-0102-TS
3/4"	7	STSB-0304-TS	STSR-0304-TS	STSC-0304-TS	STSW-0304-TS
1"	5	STSB-1000-TS	STSR-1000-TS	STSC-1000-TS	STSW-1000-TS



### 2:1 - O Type - Thin Wall Polyolefin

SIZE	PCS BAG	BLACK	RED	GREEN	BLUE	YELLOW	CLEAR	WHITE
1/8"	15	STOB-0108-TS	STOR-0108-TS	STOG-0108-TS	STOL-0108-TS	STOY-0108-TS	STOC-0108-TS	STOW-0108-TS
3/16"	15	STOB-0316-TS	STOR-0316-TS	STOG-0316-TS	STOL-0316-TS	STOY-0316-TS	STOC-0316-TS	STOW-0316-TS
1/4"	15	STOB-0104-TS	STOR-0104-TS	STOG-0104-TS	STOL-0104-TS	STOY-0104-TS	STOC-0104-TS	STOW-0104-TS
3/8"	12	STOB-0308-TS	STOR-0308-TS	STOG-0308-TS	STOL-0308-TS	STOY-0308-TS	STOC-0308-TS	STOW-0308-TS
1/2"	10	STOB-0102-TS	STOR-0102-TS	STOG-0102-TS	STOL-0102-TS	STOY-0102-TS	STOC-0102-TS	STOW-0102-TS
3/4"	8	STOB-0304-TS	STOR-0304-TS	STOG-0304-TS	STOL-0304-TS	STOY-0304-TS	STOC-0304-TS	STOW-0304-TS
1"	4	STOB-1000-TS	STOR-1000-TS	STOG-1000-TS	STOL-1000-TS	STOY-1000-TS	STOC-1000-TS	STOW-1000-TS





# PYTHON SHRINK™



## CABLE REPAIR SLEEVES

CRS sleeves close easily with a permanent locking system that consists of a raised rail profile and a stainless steel channel. These sleeves are made from crosslinked polyolefin which equals or exceeds the material properties of the original cable jacket. CRS sleeves fit a wide range of cable sizes and have unlimited shelf life.

- 3:1 shrink ratio
- Provides water tight seal upon recovery
- Offers mechanical durability
- Application procedure is quick, simple and clean
- Steel channel provides permanent closure system
- Can be trimmed to desired length
- Installation temperature range: -35°C to 100°C



PART NO	APPROXIMATE CABLE SIZE*	LENGTH	ID BEFORE SHRINK	ID RECOVERED	WALL THICKNESS RECOVERED
STCR-0169-48	#2 AWG - 2/0 AWG	48"	1.69	.39	.09
STCR-0169-12	#2 AWG - 2/0 AWG	12"	1.69	.39	.09
STCR-0295-48	3/0 AWG - 400 MCM	48"	2.95	.59	.10
STCR-0295-12	3/0 AWG - 400 MCM	12"	2.95	.59	.10
STCR-0366-48	500 - 1000 MCM	48"	3.66	.98	.10
STCR-0539-48	1000 - 2000 MCM	48"	5.39	1.34	.10
STCR-0630-48	N/A	48"	6.30	1.65	.10

## HEAT GUNS



- High temperature and power ratings: 1000°F/540°C at up to 1740 watts
- High air flow rating: 23 CFM at 3000 FPM gets the job done fast
- Powerful high speed universal motor
- Sturdy die cast housing
- Kit includes Heat Gun, Shrink Attachment, Spreader Attachment and Storage Case.
- Use to bend plastics, cure adhesives, dry parts, heat parts and shrink tubing.

PART NO	DESCRIPTION	TEMP RANGE
TLHG-1000	ECONOMY HEAT GUN W/CASE	750° - 1000°
TLHG-3000	MASTER APPLIANCE HEAT GUN	200° - 300°
TLHG-3001	MASTER APPLIANCE HEAT GUN	300° - 500°
TLHG-3002	MASTER APPLIANCE HEAT GUN	500° - 750°
TLHG-3003	MASTER APPLIANCE HEAT GUN	750° - 1000°



# PYTHON SHRINK™



## DIRECT BURIAL SPLICE KITS



- 14 to 8 gauge copper wire rated to 600V
- For direct underground burial of UF wire
- Includes 4 conductor splice connector
- Includes the UL listed shrink tubing required for application



PART NO	DESCRIPTION	WIRE RANGE
UFSK-0830	UF CABLE SPLICE DIRECT BURIAL FOR UP TO 4 CONDUCTORS	14/3 - 8/3



- For direct underground burial
- Includes single conductor mechanical connector
- Includes UL listed shrink tubing required for splice



PART NO	DESCRIPTION	WIRE RANGE
UFSK-0831	DUAL RATED MECHANICAL SPLICE KIT DIRECT BURIAL	#8 AWG - #2 AWG
UFSK-0832	DUAL RATED MECHANICAL SPLICE KIT DIRECT BURIAL	#1 AWG - 250 MCM

## SUBMERSIBLE SPLICE KITS



- Dual Wall features a polyolefin exterior with an inner melt liner for a weatherproof seal.
- Features a thick outer polyolefin jacket with an inner adhesive liner.
- Each kit contains tin plated copper butt splices
- For copper to copper connections only

WIRE SIZE	CONDUCTORS	CLEAR DUAL WALL	BLACK DUAL WALL	BLACK HEAVY WALL
12-10 AWG	3	USKC-1203	USKB-1203	USKH-1203
12-10 AWG	4	USKC-1204	USKB-1204	USKH-1204
#8 AWG	3	USKC-0804	USKB-0804	USKH-0804
#6 AWG	3	USKC-0604	USKB-0604	USKH-0604



# PYTHON SHRINK™

## COLD SHRINK

STCS series cold applied splice sealing products are made of specially formulated silicone rubber that offer excellent insulation and moisture proof sealing for in-line cable connector systems or elbow to cable jacket applications. The rubber sleeves are factory expanded and held over a removable, plastic rip core housing. Installs quickly and easily.

- Ease of installation
- Suitable for a wide range of cable sizes
- UV resistance
- 1000V rating as a primary insulation cover
- No special tools or training required for installation
- Operating temperature: -40°C to 105°C



NO HEAT  
REQUIRED



2:1 shrink ratio

PART NO	NOM SIZE BEFORE SHRINK	APPROXIMATE CABLE SIZE*	ID BEFORE SHRINK	ID RECOVERED	RELAXED TUBE LENGTH
STCS-0750	3/4"	#2 AWG - 1/0 AWG	.75	.37	8.00
STCS-1500	1-1/2"	2/0 AWG - 400 MCM	1.50	.51	9.00
STCS-2000	2"	500 MCM - 800 MCM	2.00	.97	9.00
STCS-3000	3"	900 MCM - 1000 MCM	3.00	1.25	9.00
STCS-4000	4"	1250 MCM - 2000 MCM	4.00	1.63	9.00

\* Cable size listed is approximated based on THHN/TFHN/ OD specifications. Please consult your wire manufacturer for proper fitment. Terminations and splices are not calculated in this application guide.

## DIRECT BURIAL SPLICE AND ELECTRONIC POTTING KITS

The Shake N' Seal™ ES Kits are UL Listed and specifically designed for electrical applications up to 600 volts or equivalent by providing a permanent water tight seal.



URB kits for potting and encapsulating electronics. Each kit contains 4 cartridges. Dispenser and mixing nozzles sold separately.

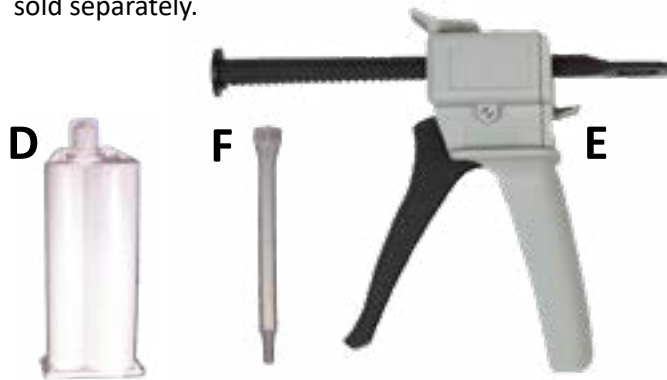

PART NO	MODEL	MAX CONDUCTORS	CONDUCTOR RANGE END SPLICE	CONDUCTOR RANGE BUTT SPLICE
ES137S	A	10	18 - 1 AWG	N/A
ES200S	A	20	18 - 1 AWG	N/A
ES200SV	B	14	18 - 1 AWG	18 AWG - 4/0 AWG
ES1150	C	4	N/A	8 AWG - 250 MCM
URB144C75-1	D	UV INDOOR/OUTDOOR ELECTRONIC POTTING AND ENCAPSULATING COMPOUND		
ACDMA-50	E	DISPENSING DEVICE FOR URB144C75-1		
AC0524L	F	MIXING NOZZLE FOR URB144C75-1		



# ELECTRICAL TAPES

## PVC ELECTRICAL TAPES - BLACK



- Economical all-purpose black electrical tape.
- Provides moisture-tight electrical and mechanical protection.
- Weather resistant. Resists UV rays, acids, alkalis, abrasion, moisture, and corrosion.
- Temperature range: 0°C to 80°C
- Wound on 1.5" ID core.

PART NO	SIZE	COLOR	PACK
TAEL-3460	3/4" X 60FT	BLACK	10
TAEL-2060	2" X 60FT	BLACK	EACH

## PREMIUM VINYL ELECTRICAL TAPES - BLACK



- Cold and heat resistant - Resists: UV rays, acids, alkalis, abrasion, moisture, and corrosion
- Maintains strength, adhesion and integrity over broad temperature range: -18°C to 105°C
- Premium vinyl for primary electrical insulation of wire and cable splices rated up to 600 volts
- Meets ASTM D-3005 and HHI-595 specifications

PART NO	SIZE	COLOR	PACK
TAEL-3463	3/4" X 60FT	BLACK	EACH

## PVC ELECTRICAL TAPES - COLORS 3/4" X 60



- Suitable as a phasing tape for electrical conduit, circuit wires, motor leads, and terminations

PART NO	SIZE	COLOR	PACK
TACA-3460	3/4" X 60FT	GRAY	10
TACP-3460	3/4" X 60FT	PURPLE	10
TACO-3460	3/4" X 60FT	ORANGE	10
TACY-3460	3/4" X 60FT	YELLOW	10
TACR-3460	3/4" X 60FT	RED	10
TACW-3460	3/4" X 60FT	WHITE	10
TACN-3460	3/4" X 60FT	BROWN	10
TACB-3460	3/4" X 60FT	BLUE	10

## PVC ELECTRICAL TAPES - COLORS 1/2 X 20



PART NO	SIZE	COLOR	PACK
TACA-1220	1/2" X 20FT	GRAY	10
TACO-1220	1/2" X 20FT	ORANGE	10
TACY-1220	1/2" X 20FT	YELLOW	10
TACR-1220	1/2" X 20FT	RED	10
TACW-1220	1/2" X 20FT	WHITE	10
TACN-1220	1/2" X 20FT	BROWN	10
TACB-1220	1/2" X 20FT	BLUE	10





# ELECTRICAL TAPES

## LOW VOLTAGE RUBBER TAPE W/LINER



- High quality, un-vulcanized EPR rubber with first-rate self-amalgamating properties carried on a thick poly liner
- Primary insulation for electrical wires and cables splices of not more than 600V
- Suitable for industrial pipe repair, automotive, marine, construction, and many other general applications
- Dielectric strength 490 volts per mil
- Flexible over a wide temperature range: Max operating temperature 176°F
- UL 510 listed. Meets requirements of ASTM-D119 and HHI-553C

PART NO	SIZE	COLOR	PACK
TARU-3422	3/4" X 22yds	BLACK	EACH
TARU-2022	2" X 22yds	BLACK	EACH

## 30MIL HIGH VOLTAGE RUBBER TAPE - W/LINER



- Self-bonding, highly conformable, 30 mil EPR rubber wound on a heavy duty woven poly liner.
- Use as a primary electric insulation for low and high voltage applications through 69 kV.
- Designed for Telcom and Utility applications.
- Rated for up to 194°F continuous operating temperature and intermittent service at 266°F.

PART NO	SIZE	COLOR	PACK
TARH-3422	3/4" X 22yds	BLACK	EACH
TARH-2022	2" X 22yds	BLACK	EACH

## LIQUID ELECTRICAL TAPE



Out-performs common electrical tape by sealing out moisture and dirt to virtually eliminate corrosion, which causes many electrical failures. Sticks to metal, wiring, rubber, vinyl and plastic, forming a tough flexible coating that dries at room temperature in 5 minutes. Handy applicator top and thicker formula is great for getting into tight places that just cannot be reached with ordinary tape. Use anywhere a dependable weather-proof connection is required.

PART NO	SIZE	DESCRIPTION
49412	4 Oz	BRUSH TOP CAN



Visit us on the web at  
[www.posi-tech.com](http://www.posi-tech.com)



# ELECTRICAL TAPES

## GLASS CLOTH TAPE - RUBBER ADHESIVE



- Provides heat stable insulation for use on motor leads, and switches, and controls
- 7mil thickness
- Insulation class: 130°C (266°F)
- Dielectric strength 3,300 volts
- Tensile Strength: 170 lb/in
- Meets UL requirements and MIL-I-15126F (Type GFT)

PART NO	SIZE	COLOR	PACK
TAGL-3466	3/4" X 66FT	WHITE	EACH
TAGL-1066	1" X 66FT	WHITE	EACH

## SILICONE



Silicone Tape is a self-fusing, repair tape that conforms to any surface while providing a water-tight seal. Silicone Tape creates a chemical, moisture-resistant barrier that fixes leaky pipes, hoses and insulates frayed electrical wires. It is easy to remove, leaves no sticky residue and protects from corrosion. Ideal for marine, automotive, plumbing and household applications, plus many more!

- Insulates up to 8,000 volts
- 300% Stretch
- -85°F to 500°F

PART NO	SIZE	COLOR	PACK
TSIB-1010	1" x 10FT	BLACK	EACH

## MASTIC RUBBER WRAP



- Self-bonding 1/8" thick (125mil) electrical grade rubber mastic
- Use for insulating and moisture sealing splices and terminations on solid electric cable
- Can be wrapped, stretched or molded around irregular shapes for insulation build up, water sealing and surface protection
- Apply an overwrap of premium vinyl for optimum durability and protection
- Widely used for cellular tower electrical splices
- Made in USA

PART NO	SIZE	COLOR	PACK
TAMR-2510	2-1/2"(W) X 10FT(L)	BLACK	EACH

## FRICTION TAPE



- Cotton cloth impregnated with scientifically compounded pure rubber based adhesive for maximum elasticity and moisture resistance
- Dielectric strength: 1,000 volts
- Standard color: black
- Tape Thickness: 15.0 mil
- Tensile Strength: 40 lb/in

PART NO	SIZE	COLOR	PACK
TAFR-3460	3/4" X 60FT	BLACK	EACH
TAFR-2060	2" X 60FT	BLACK	EACH



# CONSTRUCTION TAPES

## DUCT TAPE - CLOTH BACKED



100% Dacron® cloth/polyethylene (PE) film with an aggressive pressuresensitive natural rubber adhesive combines to provide a quality utility product. Consistent tensile and even tear in both cross and machine direction. Excellent conformability to irregular surfaces.

Tested in accordance with UL-723

Backing: PE film  
Adhesive Natural: Rubber/Resin  
Reinforcement: PET Cloth



PART NO	SIZE	THICKNESS	TENSILE	PACK	COLOR
TADU-1860	1.88" X 60YDS	6 MIL	16.5LBS	24	GRAY
TADU-2060	1.88" X 60YDS	8 MIL	18LBS	24	GRAY
TADB-2060	1.88" X 60YDS	8 MIL	18LBS	24	BLACK
TADU-2061	1.88" X 60YDS	10 MIL	20LBS	24	GRAY

## MASKING TAPE - INDUSTRIAL GRADE



- Mid grade performance for use in masking applications where moderate heat is applied.
- Rated service temperature 0°F to 203°F
- Tape Thickness: 5.6 mil
- Tensile Strength: 20 lb/in

PART NO	SIZE	THICKNESS	PACK	COLOR
TAMA-3460	3/4" X 60YDS	5.6 MIL	48	NATURAL
TAMA-1060	1" X 60YDS	5.6 MIL	36	NATURAL
TAMA-2060	2" X 60YDS	5.6 MIL	24	NATURAL

## MASKING TAPE - PAINTERS GRADE

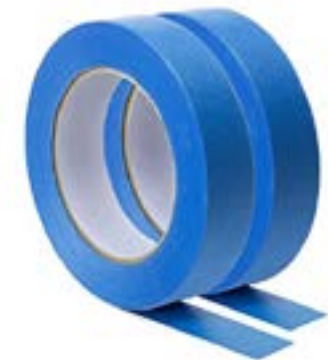

- Special adhesive system permits clean removal from a wide variety of surfaces for up to 7 days
- UV and solvent resistant to prevent bleed through in painting applications
- Not recommended for lacquer applications
- Tape Thickness: 5.5 mil
- Tensile Strength: 22 lb/in

PART NO	SIZE	THICKNESS	PACK	COLOR
TAMB-3460	3/4" X 60YDS	5.5 MIL	48	BLUE
TAMB-1060	1" X 60YDS	5.5 MIL	36	BLUE
TAMB-2060	2" X 60YDS	5.5 MIL	24	BLUE



# GENERAL PURPOSE TAPES

## PTFE PIPE THREAD SEALING TAPE



- Tape Thickness: 4mil
- Standard Density: 0.36 gm/cm3 – 100% virgin PTFE
- Suitable for standard, non-challenging thread seal requirements
- Temperature range – 375°F to 500°F

PART NO	SIZE	THICKNESS	PACK	COLOR
TATL-1226	1/2" X 260"	4 MIL	100	WHITE
TATL-1252	1/2" X 520"	4 MIL	100	WHITE
TATL-3452	3/4" X 520"	4 MIL	70	WHITE

## ACRYLIC CARTON SEALING TAPE



- Tensile Strength: 24 lb/in
- Adhesion: 20 oz/in

PART NO	SIZE	THICKNESS	PACK	COLOR
TAPS-2055	2" X 55YDS	1.8MIL	36	CLEAR
TAPS-2011	2" X 110YDS	2.0MIL	36	CLEAR
TAPS-3011	3" X 110YDS	2.0MIL	24	CLEAR

## STRETCH FILM - HAND APPLIED



- Good puncture resistance, tensile strength, elongation and performance
- Excellent load retention and stretch memory
- Provides compressive force for tighter load holding
- Will perform consistently at higher stretch levels, resulting in excellent cost performance value

PART NO	SIZE	THICKNESS	PACK	COLOR
TASF-1800	18" X 1500FT	80GA	4	CLEAR
TASB-1800	18" X 1500FT	80GA	4	BLACK
TASL-1800	18" X 1500FT	80GA	4	BLUE

## STRETCH FILM APPLICATOR



An excellent, durable dispenser for all 12"-20" stretch film rolls, ideal for light to medium duty warehouse applications.

PART NO	SIZE
TLSF-1000	12-20" ROLLS







# WARNING TAPES

## BARRICADE TAPES



- Long lasting marking solutions for off-limit areas or crowd control
- Durable non-adhesive Polyethylene film with bright visible colors (Yellow or Red)
- Standard legends in black lettering

PART NO	SIZE	LEGEND	THICKNESS	PACK	COLOR
TABN-0300	3" X 300FT	CAUTION CAUTION	1.5MIL	16	YELLOW
TABN-3000	3" X 1000FT	CAUTION CAUTION	2.0MIL	8	YELLOW
TABN-6000	6" X 1000FT	CAUTION CAUTION	2.0MIL	3	YELLOW

PART NO	SIZE	LEGEND	THICKNESS	PACK	COLOR
TARN-0300	3" X 300FT	DANGER DANGER	2.0MIL	16	RED
TARN-3000	3" X 1000FT	DANGER DANGER	2.0MIL	8	RED
TARN-3001	3" X 1000FT	DANGER DO NOT ENTER	2.0MIL	8	RED

## BARRICADE TAPE DISPENSER



Dispenses Barricade tape quickly and easily avoiding waste and snarls. The combined tape storage, transport, and dispensing reel is made from sturdy polypropylene. Its portable lightweight construction is equipped with a hardened steel safety cutting blade and carrying handle to make dispensing barricade tape fast and easy. A retaining bar secures the tape in the housing cylinder providing instant visual inspection of the remaining tape on the reel. Accommodates Standard 3" width rolls

PART NO	FIGURE	SIZE
TLBT-1000	A	3" UP TO 1000FT
TLBT-2000	B	3" UP TO 1000FT

## NEON FLAGGING TAPE



PART NO	SIZE	THICKNESS	PACK	COLOR
TAFO-1315	1-3/16" X 150FT	4MIL	12	ORANGE
TAFP-1315	1-3/16" X 150FT	4MIL	12	PINK
TAFR-1315	1-3/16" X 150FT	4MIL	12	RED
TAFG-1315	1-3/16" X 150FT	4MIL	12	LIME GREEN



Visit us on the web at  
[www.posi-tech.com](http://www.posi-tech.com)



# BURIAL TAPES

## BURIAL TAPES - NON-DETECTABLE



Non-detectable underground marking tape identifies and protects buried utility lines. Non-Detectable underground marking tape acts as a "STOP SIGN" to prevent accidental "dig-ins".

Also available in the following configurations:

- TAAN - **POTABLE WATER**
- TASN - **SEWER**
- TAGN - **GAS**



PART NO	SIZE	LEGEND	THICKNESS	PACK	COLOR
TAWN-3000	3" X 1000FT	ELECTRIC LINE BURIED BELOW	4.0MIL	6	RED
TAWN-6000	6" X 1000FT	ELECTRIC LINE BURIED BELOW	4.0MIL	3	RED
TAYN-3000	3" X 1000FT	ELECTRIC LINE BURIED BELOW	4.0MIL	6	YELLOW

PART NO	SIZE	LEGEND	THICKNESS	PACK	COLOR
TAPN-3000	3" X 1000FT	FIBER OPTIC LINE BURIED BELOW	4.0MIL	6	ORANGE
TAPN-6000	6" X 1000FT	FIBER OPTIC LINE BURIED BELOW	4.0MIL	3	ORANGE
TAPN-3001	3" X 1000FT	COMMUNICATIONS LINE BURIED BELOW	4.0MIL	6	ORANGE

## BURIAL TAPES - DETECTABLE



Detectable Marking Tape is used for detecting, locating, identifying, and protecting buried utility lines for gas, water, sewer, telecommunication, and electrical markets. The width of tape used, is determined by the size of, and depth at which the underground utility line is buried. The depth at which detectable tape is buried, is determined by the width of the tape used.

Also available in the following configurations:

- TAAD - **POTABLE WATER**
- TASD - **SEWER**
- TAGD - **GAS**



PART NO	SIZE	LEGEND	THICKNESS	PACK	COLOR
TAWD-3000	3" X 1000FT	ELECTRIC LINE BURIED BELOW	5.0MIL	6	RED
TAWD-6000	6" X 1000FT	ELECTRIC LINE BURIED BELOW	5.0MIL	3	RED

PART NO	SIZE	LEGEND	THICKNESS	PACK	COLOR
TAPD-3000	3" X 1000FT	FIBER OPTIC LINE BURIED BELOW	5.0MIL	6	ORANGE
TAPD-6000	6" X 1000FT	FIBER OPTIC LINE BURIED BELOW	5.0MIL	3	ORANGE
TAPD-3001	3" X 1000FT	COMMUNICATIONS LINE BURIED BELOW	5.0MIL	6	ORANGE



# FIRESTOP PRODUCTS

## COMMERCIAL FIRESTOP FOAM



BOSS® 813 can be used on any commercial or residential construction where the code calls for a UL system for penetration of wires, cables and metal pipes through drywall, concrete or wood. (Please consult the UL directory for a full list of approved systems). BOSS® 813 can also be used as a fireblock/draftstop in non-fire rated construction. BOSS® 813 prevents the spread of fire, smoke and toxic gasses from one compartment to another, while still maintaining the integrity of the Firewall. BOSS® 813 has excellent insulation and acoustic properties, and is also paintable (after inspection).

BOSS® 813 meets or exceeds all building codes including the new International Building Code. BOSS® 813 has been tested as a Through Penetration Firestop for 1 & 2 hour fire rated construction and is listed to UL 1479 (ASTM E-814) BOSS® 813 must be installed as tested to achieve a 1 or 2 hour rating. Visit [www.bossproducts.com](http://www.bossproducts.com) for a "Complete Firestop Systems Guide" and view the systems as they were tested for proper installation

PART NO	SIZE	CASE
813	24oz	12

## COMMERCIAL FIRESTOP SEALANT



Firestop-814+ Elastomeric Intumescent Firestop Sealant offers comprehensive UL Testing for a wide range of electrical, plumbing, HVAC and head-of-wall applications for "Through Penetrations" found in up to 3 hour fire rated wood, gypsum and concrete floor & wall assemblies. Firestop-814+ is a highly flexible, general purpose firestopping sealant that conforms to ASTM-E814 (UL 1479) standards for multi-family and commercial firestopping applications.

PART NO	SIZE	CASE
CHFC-1030	10oz	12



## COMMERCIAL FIRESTOP PUTTY PADS



Flame Tech Putty Pads are non-curing, 7" x 7" x 1/8" moldable pads that Easy Installation are applied to the backside of electrical boxes to maintain the integrity of 1 & Non-Curing 2 hour fire rated gypsum walls. In fire conditions, Flame Tech Putty Pads expand to form and intumescent char that encloses the electrical box and Long Shelf Life seals off any openings that may allow the spread of flame, smoke, and toxic gases. Flame Tech Putty Pads have been UL tested and classified as a protective material for wall openings for up to 2 hours.

PART NO	SIZE	CASE
CHIP-7070	7" x 7" x 1/8"	20

## COMMERCIAL FIRESTOP PILLOWS



2" x 4" x 8" Intumescent Firestop Pillows designed to firestop large open voids and openings made for penetrating items such as cables, cable trays, ductwork, pipes, and conduits. Firestop Pillows are UL tested to maintain up to a 3 hour rating and are soft, easily stackable, self-supporting and require no mesh or sealant

PART NO	SIZE	CASE
CHPL-4080	2" x 4" x 8"	25



# FIREBLOCK PRODUCTS

## RESIDENTIAL FIREBLOCK FOAM



Handi-Foam Fireblock has a recognizable orange color allowing inspectors to easily identify the use of an approved fireblock product for Type V residential construction. Due to its expansion characteristics, Handi-Foam Fireblock is more effective than many traditional fireblocking materials for preventing the spread of air, flames and smoke in concealed penetrations, preventing flame spread from room to room and floor to floor

PART NO	DISPENSER	SIZE	CASE
P30192	STRAW	24oz	12
P30181	GUN	24oz	12

See dispensing gun below with general void fill.

## RESIDENTIAL FIREBLOCK SEALANT



Fire Caulk-136 is an economical, fire rated, non-combustible material used to fill the annular space around wires, pipes, ducts, and other mechanical penetrating items in steel and wood-framed single family residential construction. Fire Caulk is tested to ASTM-E136 standard for non-combustibility and fulfills fireblocking requirements by resuming the integrity of non-rated penetrations through top plates, ceiling, and floor openings.

PART NO	SIZE	CASE
CHFC-0136	10.1oz	12



# GENERAL VOID FILL

## NON-FIRE RATED FOAM



Handi-Foam® low pressure one-component polyurethane foam sealants are moisture-cured, multipurpose sealants designed to seal and fill small cracks and voids, creating a tight barrier against noise, moisture and air infiltration. Handi-Foam Sealants are UL GREENGUARD® Gold Certified, contributing to healthier indoor environments.

PART NO	DISPENSER TYPE	SIZE	CASE
P30002	STRAW	12oz	12
P30107	STRAW	24oz	12
P30115	GUN	24oz	12
HT300	FOR USE WITH P30181 / P30115		EACH

## DUCT SEAL



Duct Seal is used primarily by the building and specifically by the electrical trade to seal around electrical boxes, flashings, and service mast entries, etc.

PART NO	SIZE	CASE
CHDS-1000	1 LB BARS	50
CHDS-5000	5 LB BARS	10







# SEALANTS

## 100% SILICONE



Our Silicone Sealant is a high performance acetoxy curing silicone sealant adhesive that demonstrates high strength adhesion and excellent weatherability under the most severe conditions. TruSil has been specially formulated to meet low VOC requirements and is recognized for its smooth consistency, low temperature application, ease of tooling, and quick cure time. TruSil 100 adheres to a wide variety of non-porous substrates including glass, aluminum and other metals, non-porous concrete, stone, tile, ceramic, non-oily wood, fiberglass, painted surfaces, plastics, many rubbers and other building materials.

PART NO	COLOR	SIZE	CASE
CHSI-0101	CLEAR	10oz	12
CHSW-0101	WHITE	10oz	12
WL09023	CLEAR (RTV)	3oz	12



## 100% RTV SILICONE - AEROSOL



Sprayon® Silicone Sealants Aerosols provide a tough, flexible bond between wood, metal, glass, plastic, ceramic, masonry, and more. Bonds/seals cracks, holes and pores against water, dust, air leakage, chemicals, oils and greases. Paints do not adhere well to this sealant. Complete painting before applying. Not recommended for exterior, below the-waterline marine applications. Not for use in direct contact with gasoline, kerosene or other liquid solvents.

PART NO	COLOR	SIZE	CASE
SP010	CLEAR	8oz	12

## ASPHALT ROOF CEMENT



Asphalt Roof Cement is ideal for sealing leaks and openings and provides a durable, watertight seal when waterproofing, repairing or sealing roofs. Commonly applied at flashing, copings, roof decks, roof vents and repairing loose shingles.

For use on: aluminum, asphalt, brick, cement, concrete, stone, vinyl

PART NO	COLOR	SIZE	CASE
WL00215	BLACK	10oz	12

## SEALANT DISPENSING GUNS



10.1oz, half-barrel with smooth rod and quick-release mechanism. Holds most standard cartridges

PART NO	SIZE
TLCG-1000	10.1oz



10.1oz, heavy-duty uni-rail construction with hex piston rod and quick release lever. Fits all standard cartridges.

PART NO	SIZE
TLCG-2000	10.1oz



# AEROSOL PAINTS

## GENERAL PURPOSE ENAMEL SPRAY PAINTS

Industrial Work Day™ Aerosol Paints offer an economical solution to marking, color coding and miscellaneous spray paint needs where long term quality and durability are not required. These paints are available for shipment with other Krylon Industrial products. For Interior/Exterior Use On: Marking, color coding and touch-up for a variety of metal and wood surfaces.



PART NO	COLOR	SIZE	CASE
4401	GLOSS WHITE	10oz	12
4402	GLOSS BLACK	10oz	12
4403	BLUE	10oz	12
4404	GLOSS RED	10oz	12
4405	GRAY	10oz	12
4406	YELLOW	10oz	12
4407	GLOSS PINK	10oz	12
4408	GREEN	10oz	12
4409	SKY BLUE	10oz	12
4410	GOLD	10oz	12
4412	FLAT BLACK	10oz	12
4413	ORANGE	10oz	12
4414	CLEAR	10oz	12
4420	DARK GRAY	10oz	12
4422	FLAT WHITE	10oz	12
4431	BROWN	10oz	12
4456	RUE BLUE	10oz	12
4457	ALUMINUM	10oz	12
4418	GRAY PRIMER	10oz	12
4419	RED PRIMER	10oz	12

## WATER-BASED MARKING PAINTS



The Krylon® Industrial Quik-Mark™ offering provides a complete line of Marking Paints for every application: gas, water, electrical, telecommunications, sewer/drain, and other utility lines, as well as proposed excavation, road, and survey markings. The entire line of Quik-Mark Inverted Marking Paints is available in a variety of APWA and Fluorescent colors and sizes to meet all of your application needs.

PART NO	COLOR	SIZE	CASE
A03650	FLUORESCENT RED/ORANGE	20oz	12
A03715	FLUORESCENT PURPLE	20oz	12
A03700	FLUORESCENT ORANGE	20oz	12
A03901	BRILLIANT WHITE	20oz	12
A03911	BRILLIANT RED	20oz	12
A03500	CLEAR	20oz	12
A03620	FLUORESCENT CAUTION BLUE	20oz	12
A03630	FLUORESCENT SAFETY GREEN	20oz	12
A03921	HIGH VISIBILITY YELLOW	20oz	12
A03610	FLUORESCENT SAFETY RED	20oz	12
A03612	FLUORESCENT PINK	20oz	12

K07096 | QUICK-MARK HAND HELD WAND | 34" | 1





# MARKING PRODUCTS

## SPECIALTY ACRYLIC ENAMEL SPRAY PAINTS



Krylon Tough Coat Acrylic Alkyd Enamel Aerosol offers a tough, protective coating that resists chipping and peeling. Features a high-solids formula that ensures maximum coverage and performance. Enamel delivers the ultimate in protection, durability, high gloss and color retention. Perfect for light- to heavy-duty painting projects, both indoors and outdoors.

PART NO	COLOR	SIZE	CASE
R00839	LIGHT MACHINERY GRAY ANSI 61	10oz	12
R00879	DARK MACHINERY GRAY ANSI 49	10oz	12
A01580	OSHA PURPLE	10oz	12

## PERMANENT MARKERS

Ticonderoga RediSharp Markers are the perfect marker for all permanent marking. They can be used on most indoor and outdoor surfaces, including paper, plastic, metal, glass, wood and leather. RediSharp feature a patented thumb button cap for one hand cap release. AP Certified non-toxic. Conforms to ASTM standards.



PART NO	COLOR	SIZE	CASE
SHRP-1000	BLACK	FINE	12
SHRP-2000	BLACK	MEDIUM	12
SHRP-3000	BLACK	LARGE	12

## LUMBER CRAYONS

Extruded lumber crayons last up to 10 times longer than ordinary molded wax crayons. Fade-proof, water-proof, smear-proof. Won't melt in direct sunlight. Will work on wet (green) lumber or dry wood, metal, concrete and most other surfaces.



PART NO	COLOR	CASE
MPLK-0200	BLACK	12
MPLR-0200	RED	12
MPLY-0200	YELLOW	12
MPLB-0200	BLUE	12
MPLW-0200	WHITE	12



Visit us on the web at  
[www.posi-tech.com](http://www.posi-tech.com)



# AEROSOL CHEMICALS

## CONTACT CLEANERS



Sprayon® Electrical Contact Cleaner & Protectant Aerosol is intended to clean/degrease electrical equipment when electrical current exists or when there is a residual electrical potential from a component. Instant solvent and cleaning action leaving a fine, microscopic film for protection against corrosion.

PART NO	DESCRIPTION	SIZE	CASE
EL2001	NON-FLAMMABLE	11oz	12
EL2302	FLAMMABLE - SAFE ON PLASTICS	11oz	12

## ELECTRICAL LACQUER SEALER



Sprayon® Clear Electrical Lacquer Sealer Aerosol seals electrical and electronic parts. Weather/water proofs in one application. Protects against rust, corrosion, tarnish. Resists fungus, chemicals, dirt, grease. Dries to a crystal clear, flexible film. Has exceptional resistance to vegetable oils, mineral oils, greases, chemical fumes. Meets MIL-TT-L-50G.

PART NO	DESCRIPTION	SIZE	CASE
EL2000	WEATHER AND WATERPROOF - CLEAR	11oz	12

## RED INSULATING VARNISH



Sprayon® EL601 Red Insulating Varnish Aerosol is an insulating spray for general coating, impregnating and insulating electrical and electronic work. Excellent adhesion, flexibility, and water resistance. Protects surface against oils, moisture, acid and alkalis. Meets NEMA & UL Class F Requirements.

PART NO	DESCRIPTION	SIZE	CASE
EL601	RESISTS OIL, MOISTURE, ACIDS AND ALKALIS	15.25oz	12
EL601GAL	RESISTS OIL, MOISTURE, ACIDS AND ALKALIS	GALLON	4

## ELECTRIC MOTOR DEGREASER



Sprayon® EL703 Electric Motor Degreaser Aerosol instantly penetrates and removes dirt, oil, grease, wax and moisture from electrical equipment and machinery. Formulated to clean/degrease electrical equipment when electrical current exists or when there is a residual electrical potential from a component.

PART NO	DESCRIPTION	SIZE	CASE
EL703	NON-FLAMMABLE	19oz	12

## ELECTRICAL DEGREASER



Sprayon® EL848 Electrical Degreaser (Flash Free™) Aerosol is a non-flammable, fast-evaporating cleaner that penetrates instantly to remove dirt, oil, grease and wax. Increases the life of electrical components by removing foreign materials that can cause costly downtime. Replaces 1,1,1 Trichloroethylene

PART NO	DESCRIPTION	SIZE	CASE
EL848	NON-FLAMMABLE	13oz	12





# AEROSOL CHEMICALS

## WHITE LITHIUM GREASE



Sprayon® LU100 White Lithium Grease Aerosol is a high solids white grease that provides excellent lubrication for metal-to-metal applications and serves as an excellent corrosion inhibitor for unpainted metal.

PART NO	DESCRIPTION	SIZE	CASE
LU100	FOR USE ON CHAINS, GEARS, DRIVES	11oz	12

## RUST BREAKER



Sprayon® LU103 Heavy-Duty Rust Penetrant (Rust Breaker®) Aerosol quickly loosens rust while penetrating grease and dirt. This high-performance, non-flammable penetrant is transparent and non-staining.

PART NO	DESCRIPTION	SIZE	CASE
LU103	RUST PENETRANT - NON-FLAMMABLE	11oz	12

## DRY FILM MOLY LUBRICANT



Sprayon® LU200 Dry Film Moly Lubricant Aerosol is a high solids, molybdenum disulfide coating that withstands high pressures. This non-conductive lubricant bonds to all clean surfaces that are not adversely affected by alcohol or aromatic hydrocarbons (toluene or xylene) resulting in a high performance dry film lubricant

PART NO	DESCRIPTION	SIZE	CASE
LU200	NON-CONDUCTIVE	11oz	12

## MOLY CHAIN LUBRICANT



Sprayon® LU202 Moly Chain Lubricant Aerosol is a high-viscosity, non-drying oil that clings to moving parts and metal-to-metal applications to provide long-lasting lubrication and reduce friction. The foaming action penetrates close tolerances of chain drive bushings and pins and the moly additive improves its load carrying capacity (will work under extreme pressures).

PART NO	DESCRIPTION	SIZE	CASE
LU202	FOAMING ACTION	11oz	12

## ALL-PURPOSE SILICONE LUBRICANT



Sprayon® LU206 All-Purpose Silicone Lubricant Aerosol is economical for applications where petroleum based products are not desired. 5% silicone formula protects against air and moisture to retard oxidation and corrosion. It virtually eliminates friction and sticking to improve high-speed production.

PART NO	DESCRIPTION	SIZE	CASE
LU206	PAINTABLE	10oz	12



# AEROSOL CHEMICALS

## CUTTING OIL - AEROSOL



Sprayon® LU208 Cutting Oil Aerosol is an excellent lubricant specifically formulated for all ferrous and non-ferrous machining operations. Extends tool life, reducing tool sharpening downtime. It utilizes a unique combination of friction reducing triglycerides which aides in a high degree of fluid film protection.

PART NO	DESCRIPTION	SIZE	CASE
LU208	AEROSOL JET SPRAY	12oz	12

## ALL PURPOSE LUBRICANT - THE PROTECTOR™



Sprayon® LU711 All-Purpose Lubricant (The Protector™) Aerosol is an ultra-thin film, transparent blend of high quality petroleum distillates formulated to ensure maximum moisture displacement. Its film resists the collection of abrasive particles on delicate contacts & connectors. This general maintenance penetrant is unmatched in its versatility & quality.

PART NO	DESCRIPTION	SIZE	CASE
LU711	RUST PENETRANT - NON-FLAMMABLE	11oz	12

## OUTDOOR METAL PROTECTANT



Sprayon® LU777 Outdoor Metal Protectant Aerosol is a waxy corrosion preventative that offers excellent lubrication and long-term outdoor protection. Its tacky film provides an excellent barrier to salt spray and high humidity. Meets MIL-C-16173D- Grade 2.

PART NO	DESCRIPTION	SIZE	CASE
LU777	24 MONTH DURABILITY	11oz	12

## HEAVY DUTY CITRUS DEGREASER



Sprayon® CD757 Heavy-Duty Citrus Degreaser Aerosol is a heavy duty, multi-purpose degreaser, adhesive and graffiti remover. This non-chlorinated formula has the cleaning power of solvents to remove grime, dirt, grease and oil. An outstanding biodegradable cleaner for use in general maintenance, public buildings. Ideal as a cleaner prior to painting.

PART NO	DESCRIPTION	SIZE	CASE
CD757	BIODEGRADABLE - NON-CHLORINATED	16oz	12

## COIL AND FIN CLEANER



Sprayon® CD887 Coil & Fin Cleaner Aerosol is a heavy-duty water-based foaming coil cleaner designed to remove stubborn grease, grime and chloride build up that can accumulate on refrigeration and A/C coils. Its foaming and penetrating action ensures proper coverage and cleaning of finned areas.

PART NO	DESCRIPTION	SIZE	CASE
CD887	NON-FLAMMABLE - NON-CORROSIVE	18oz	12



# PPE CHEMICALS

## WASP AND HORNET KILLER



Sprayon® SP857 Blast'Em Wasp & Hornet Killer is perfect for killing wasps, hornets, yellow jackets without getting close to the insects. It contains a high amount of petroleum distillates for the best knockdown and kill rate. The 20 oz. Aerosol comes equipped with the Accu-Sol™ Ergonomic Trigger Spray Nozzle which sprays from a distance of up to 20 ft.

PART NO	DESCRIPTION	SIZE	CASE
SP857	DIELECTRIC STRENGTH: 33,000 VOLTS	20oz	12

## NATRAPEL™ INSECT REPELLANT



- CDC recommended formula of 20% Picaridin is the recommended concentration to guard against diseases transmitted by insects including the Zika Virus, West Nile Virus, Eastern Equine Encephalitis, Lyme Disease, and Dengue Fever
- Easy to apply and easy on the air with a continuous spray without releasing harmful aerosols
- Enjoy 12+ hours of insect protection
- Safe on your gear as the DEET free formula won't melt jackets, fishing line, and other plastics

PART NO	DESCRIPTION	SIZE	CASE
6772	NATRAPEL 8 HOUR AEROSOL	6oz	12
6878	NATRAPEL 8 HOUR PUMP BOTTLE	3.4oz	12
6095	NATRAPEL 8 HOUR WIPES	3" x 6" x 10"	12

## HAND CLEANER



Orange GOOP™ liquid gel is a 'waterless' hand cleaner that gets hands 'dinner table clean' quickly, with the power of Orange. Orange GOOP™ uses all natural citrus cleaners to remove the toughest of soils, with no harsh chemicals or solvents, and is infused with natural humectants to keep your hands soft. Orange GOOP™ is available in multiple sizes, with fine pumice scrubbers to help remove those extra tough stains, or without pumice to soothe sensitive hands.

PART NO	DESCRIPTION	SIZE	CASE
549	ORANGE GOOP HAND CLEANER W/PUMICE	16oz	12
548	ORANGE GOOP HAND CLEANER W/PUMICE	1/2 GAL	6
46	ORANGE GOOP HAND CLEANER W/PUMICE	GAL	4
950	RUFF TOWELS W/PUMICE	72 CT	6



Visit us on the web at [www.posi-tech.com](http://www.posi-tech.com)



# PVC CEMENT



## REGULAR BODY CLEAR



Clear, regular bodied, high strength, fast setting PVC solvent cement for all classes and schedule, except schedule 80. For use on PVC pipes and fittings. This cement may be used for up to 4" pipes and fittings with interference fit for potable water, irrigation, drain, waste, vent, sewer and conduit applications.

PART NO	DESCRIPTION	SIZE	CASE
CHPC-0063	REGULAR BODY CLEAR UP TO 4"	1/2 PINT	24
CHPC-0125	REGULAR BODY CLEAR UP TO 4"	PINT	12
CHPC-0250	REGULAR BODY CLEAR UP TO 4"	QUART	12
CHPC-1000	REGULAR BODY CLEAR UP TO 4"	GALLON	4

## MEDIUM BODY CLEAR



Clear, medium bodied, high strength, fast setting PVC solvent cement for all classes and schedule. For use on PVC pipes and fittings. This cement may be used for up to 6" pipes and fittings with interference fit for potable water, irrigation, drain, waste, vent, sewer and conduit applications.

PART NO	DESCRIPTION	SIZE	CASE
CHPM-0063	MEDIUM BODY CLEAR UP TO 6"	1/2 PINT	24
CHPM-0125	MEDIUM BODY CLEAR UP TO 6"	PINT	12
CHPM-0250	MEDIUM BODY CLEAR UP TO 6"	QUART	12
CHPM-1000	MEDIUM BODY CLEAR UP TO 6"	GALLON	4

## MEDIUM BODY BLUE FOR WET APPLICATIONS



Blue medium bodied, high strength, fast setting PVC solvent cement for all classes and schedules. For use on PVC pipes and fittings. For use on pipes and fittings with interference fit up to 6". Formulated for wet conditions and suitable for potable water, irrigation, drain, waste, vent, sewer and conduit.

PART NO	DESCRIPTION	SIZE	CASE
CHPS-0250	MEDIUM BODY BLUE FOR WET APPLICATIONS	QUART	12

## CLEANERS, PRIMERS AND PARTS



- Clear cleaner is for use on PVC, CPVC, ABS and Styrene pipes and fittings. This cleaner helps remove dirt, oil, grease and grime from the joining surfaces prior to primer application
- Primer is for use on PVC and PVC pipes and fittings. This primer helps soften the joining surfaces prior to the solvent cement application

PART NO	DESCRIPTION	SIZE	CASE
CHPK-0125	PVC CLEANER CLEAR	PINT	12
CHPK-0250	PVC CLEANER CLEAR	QUART	12
CHPR-0125	PVC PRIMER PURPLE	PINT	12
CHPR-0250	PVC PRIMER PURPLE	QUART	12
CHPE-0250	EMPTY CAN AND DAUBER	QUART	EACH





# LUBRICANTS



## DARK CUTTING OIL



Black Swan Dark Cutting Oil is a heavy duty sulfurized-chlorinated base oil that helps cut clean, sharp threads on steel and brass pipe. It is formulated to reduce friction during the machining process. By reducing this friction heat generation is minimized. The results are cleaner, sharper threads, better fitting joints and longer tool life.

PART NO	DESCRIPTION	SIZE	CASE
CHCO-4242	DARK CUTTING OIL	QUART	12
CHCO-1000	DARK CUTTING OIL	GALLON	6

## ANCHOR LUBE™ CUTTING LUBRICANT



Anchorlube is the future of multi-purpose lubricants, offering a new level of tool-life along with the cleanliness of a water/soap based compound. Anchorlube is a semi-paste and performs well on all metals, especially stainless steel and other exotic metals that tend to shorten tool life considerably. It is a clean lubricant that contains no petroleum, chlorine, or sulfur, and is a water-based soap, maintaining a clean work area with no oily surfaces.

PART NO	DESCRIPTION	SIZE	CASE
CHLU-0400	ANCHOR LUBE SQUEEZE TUBE	4oz	12
CHLU-0800	ANCHOR LUBE SQUEEZE TUBE	8oz	12
CHLU-1600	ANCHOR LUBE SQUEEZE TUBE	16oz	12
CHLU-0771	ANCHOR LUBE	Gallon	4

## CLEAR WIRE PULLING LUBE



Posi-tech Wire Pulling Lubricant is a premium grade lubricant that reduces friction and limits surface tension making difficult wire pulling applications quick and easy. Posi-tech is compatible with all cable jackets and possesses excellent cling characteristics. Non-corrosive and non-toxic.

PART NO	DESCRIPTION	SIZE	CASE
CHWP-0250	CLEAR LUBE SQUEEZE BOTTLE	QUART	12
CHWP-1000	CLEAR LUBE PAIL	GALLON	4
CHWP-5000	CLEAR LUBE BUCKET	5 GAL	EACH

## ANTI-OX FOR AL/CU CONNECTIONS



Anti-Ox is used for aluminum to copper and aluminum to aluminum wire connections and improves the conductivity and overall service life of the electrical connection.

PART NO	DESCRIPTION	SIZE	CASE
CUAL-0400	ANTI-OX FOR AL/CU CONNECTIONS	40z	12
CUAL-1000	ANTI-OX FOR AL/CU CONNECTIONS	80z	12

# WIRE PULLING SUPPLIES



## PULLING TWINE



- Will not rot, mildew or rust
- Ships in plastic pail for ease of use

PART NO	DESCRIPTION	LENGTH	TENSILE
ROPL-6501	SPIRAL PULLING TWINE BLUE/WHITE	6500	210LBS

## SEINE TWINE



Twisted nylon seine twine, made of continuous filament, is strong and nearly indestructible. Excellent for tying, it resists mildew, rot, abrasion, oil, grease, and most chemicals. Also known as masons twine.

PART NO	DESCRIPTION	LENGTH	CASE
RONT-2150	NO. 9 73LB TENSILE (24LB WORKING)	525FT	EACH

## CONDUIT MEASURING TAPE



Manufactured from bonded parallel polyester fibers. This product is produced for use as a measuring tape and light weight pull cord. Each reel is printed in 1 foot increments for accurate measuring of conduit runs. Sequentially printed in 1-ft increments. Lightweight, easily blown through conduit.

PART NO	DESCRIPTION	LENGTH	CASE
ROCM-3630	CONDUIT MEASURING TAPE	3000 FT	EACH

## PULL LINE CONDUIT CARRIERS

Our Conduit Pistons, comprised of industrial foam materials, are designed for quick blowing or vacuuming through most conduits sizes from 1/2" - 6". Tough enough to clean out loose debris and reusable

Our Zip Line Packages are designed to be blown or vacuumed at speeds up to 400 Ft. in 10 seconds  
Combination piston/pull string for use in all types of conduit (IMC, EMT, PVC, rigid, etc.)

### CONDUIT PISTONS

PART NO	SIZE	CASE
CPST-0005	1/2"	EACH
CPST-0007	3/4"	EACH
CPST-0010	1"	EACH
CPST-0012	1-1/4"	EACH
CPST-0015	1-1/2"	EACH
CPST-0020	2"	EACH
CPST-0025	2-1/2"	EACH
CPST-0030	3"	EACH
CPST-0035	3-1/2"	EACH
CPST-0040	4"	EACH
CPST-0050	5"	EACH
CPST-0060	6"	EACH



### ZIP LINE PACKAGES

- Extremely efficient. Blow or vacuum a line 400 Ft. in 10 seconds.
- Combination piston/pull string
- For use in all types of conduit (IMC, EMT, PVC, rigid, etc.)

PART NO	SIZE	LENGTH	PKG
LPAK-1215	1/2"	150 FT	5
LPAK-3445	3/4"	450 FT	5
LPAK-1045	1"	450 FT	5





# ROPE



## 3 STRAND TWISTED YELLOW POLYPROPELENE



Polypropylene rope is an extremely economical rope that is strong and lightweight. Polypropylene can be stored wet and is resistant to mildew, most chemicals, and marine organisms.

PART NO	DIAMETER	LENGTH	BREAK	WORKING
ROPL-1430	1/4"	300FT	1250LBS	94LBS
ROPL-1460	1/4"	600FT	1250LBS	94LBS
ROPL-1412	1/4"	1200FT	1250LBS	94LBS
ROPL-3830	3/8"	300FT	2440LBS	203LBS
ROPL-3860	3/8"	600FT	2440LBS	203LBS
ROPL-3812	3/8"	1200FT	2440LBS	203LBS
ROPL-1230	1/2"	300FT	3780LBS	315LBS
ROPL-1260	1/2"	600FT	3780LBS	315LBS
ROPL-1212	1/2"	1200FT	3780LBS	315LBS
ROPL-5860	5/8"	600FT	5600LBS	465LBS
ROPL-5812	5/8"	1200FT	5600LBS	465LBS
ROPL-3460	3/4"	600FT	7650LBS	638LBS
ROPL-3412	3/4"	1200FT	7650LBS	638LBS

## COMPOSITE DOUBLE BRAID W/EYES



Double braided polyester composite rope is recommended for heavy pulls, especially where multiple cables are being installed. Recommended for use with power pulling equipment.

PART NO	DIAMETER	LENGTH	BREAK
RODB-3860	3/8"	600FT	5000LBS
RODB-3812	3/8"	1200FT	5000LBS
RODB-1260	1/2"	600FT	9500LBS
RODB-1212	1/2"	1200FT	9500LBS
RODB-9660	9/16"	600FT	16,150LBS
RODB-9612	9/16"	1200FT	16,150LBS
RODB-5860	5/8"	600FT	18,000LBS
RODB-5812	5/8"	1200FT	18,000LBS
RODB-3460	3/4"	600FT	26,000LBS
RODB-3412	3/4"	1200FT	26,000LBS

## WOVEN POLYESTER PULLING TAPE



Low stretch, high strength, sequentially footage marked pulling tape. Measure and pull with same product.

PART NO	WIDTH	LENGTH	STRENGTH
ROMT-1230	1/2"	3000FT	1250LBS
ROMT-5830	5/8"	3000FT	1800LBS
ROMT-3430	3/4"	3000FT	2500LBS

# PPE / SAFETY



## CLASS 2 SAFETY VESTS



- 100% polyester mesh
- 2" reflective tape
- Hook-and-loop closure
- ANSI/ISEA 107 Class 2 compliant

SIZE	YELLOW	ORANGE
LARGE	SFVY-1209	SFVO-1209
X-LARGE	SFVY-1210	SFVO-1210
XX-LARGE	SFVY-1211	SFVO-12111

## DUST MASKS



- Adjustable metal nose piece shapes easily to face
- Single strap elastic head band
- DUST-2000 features a 95% filter efficiency level effective against particulate aerosols free of oil; time use restrictions may apply
- 50 masks per box

PART NO	DESCRIPTION	BOX
DUST-1000	NUISANCE DUST MASK	50
DUST-2000	NIOSH N95 PARTICULATE MASK	20

## EAR PLUGS



- Pre-shaped foam ear plugs
- Self-adjusting foam expands to fit virtually every wearer
- Packaged for individual re-sale
- NRR 32

PART NO	DESCRIPTION	CASE
EARS-1000	DISPOSABLE FOAM PLUGS	200pr
EARS-2000	DISPOSABLE FOAM PLUGS (CORDED)	200pr

## DISPOSABLE SHOE COVERS



- Blue sanitary shoe covers feature 2 wide strips on the sole that keeps you from slipping and sliding
- Made of strong, abrasion-resistant spunbond polypropylene.
- Full elastic top stretches so you can slip them on and off easily
- 50 pair (100 each) per bag
- Available in size Large (7-10) and XL (11-13)

PART NO	DESCRIPTION	SIZE	CASE
SCOV-0500	POLYPROPELENE SHOE COVERS	LARGE 7-10	50pr
SCOV-1000	POLYPROPELENE SHOE COVERS	XL 11-13	50pr





# PPE / GLOVES

## NITRILE 6MIL GLOVES



Powder-free exam grade nitrile, free from latex and powders. Outstanding strength, wear and dexterity. Comfortable for wear and textured for excellent chemical resistance and great grip.

PART NO	SIZE	BOX QTY
HPNI-6518-L	LARGE	100 (50PAIR)
HPNI-6519-XL	X-LARGE	100 (50PAIR)
HPNI-6520-XXL	XX-LARGE	100 (50PAIR)

## STEALTH



- Flexible finger impact protection
- Synthetic leather finger sidewalls
- Lycra inner fourchettes for breathability
- 100% Machine Washable : Hang dry

PART NO	SIZE
SDG2B-04-L	LARGE
SDG2B-05-XL	X-LARGE
SDG2B-06-XXL	XX-LARGE





## EXO



- Flexible finger impact protection
- Genuine Goatskin Leather Palm
- Terry Cloth Sweat Wipe
- 100% Machine Washable : Hang dry

PART NO	SIZE
EXO2-MIGL-04-L	LARGE
EXO2-MIGL-05-XL	X-LARGE
EXO2-MIGL-06-XXL	XX-LARGE

## GRX™ CONTRACTOR GLOVES

TYPE	PART NO	DESCRIPTION
	MEDIUM GRXIND431M LARGE GRXIND431L X-LARGE GRXIND431XL	Nitrile coated dipped palm. Seamless nylon shell for secure fit. Provides excellent dry grip and will not absorb liquids into the coating. Black liner w/ gray coating.
	MEDIUM GRXIND551M LARGE GRXIND551L X-LARGE GRXIND551XL	Polyurethane palm and finger coating provides grip, abrasion resistance and dexterity. Seamless nylon shell offers outstanding breathability and comfort. Black liner w/ gray coating.
	MEDIUM GRXTM1000M LARGE GRXTM1000L X-LARGE GRXTM1000XL	Durable synthetic leather palm. Form-fitting and breathable mesh top hand. Black with red fourchettes.
	MEDIUM GRXTM1500M LARGE GRXTM1500L X-LARGE GRXTM1500XL	Soft, durable, golden deerskin palm. Form-fitting and breathable top of and. Slip fit elastic gauntlet. Black with gray fourchettes.



# FIRST AID KITS

## ANSI Z308.1 2009

The "Med Mod" system that puts fresh meds into a separate pocket in the kit at the time of sale, you will no longer run the risk of purchasing a kit with expired meds. This premium first aid kit has all the basic items as well as items which are recommended by the ANSI Z308.1 2009

Includes the following:

- Easy Access Pocket System
- Hard Plastic Case With Gasket
- Instruments & Instructions
- Major Injury supplies
- Medications & Antiseptics
- Minor Cuts & Scrape supplies



PART NO	DESCRIPTION	SIZE
FAKT-1000	ANSI FIRST AID KIT	10 PERSON
FAKT-2500	ANSI FIRST AID KIT	25 PERSON



# HEAD PROTECTION

## 4 POINT SUSPENSION HARD HATS



- 4-Point woven nylon suspension
- Features a short peak and low profile
- Accessory slots accommodate a wide variety of eye, face and hearing products
- Accommodates chin strap
- Moisture wicking brow pad is removable, washable and replaceable
- Meets the low temperature (LT) option of the Z89.1 Standard
- Slide-Lock or Ratchet size adjustment for head sizes 6.5 – 8
- Slide-Lock Cap weight: 13 oz. - Mega Ratchet Cap weight: 14 oz.
- SEI Certified



Ratchet Lock Shown

COLOR	SLIDE-LOCK	RATCHET LOCK	CASE
HIGH-VIZ PINK	SAHS-9769	SAHR-9320	12
HIGH-VIZ GREEN	SAHS-9820	SAHR-9321	12
WHITE	SAHS-9821	SAHR-9322	12
YELLOW	SAHS-9822	SAHR-9323	12
ORANGE	SAHS-9823	SAHR-9324	12
RED	SAHS-9824	SAHR-9326	12
BLUE	SAHS-9826	SAHR-9327	12
GRAY	SAHS-9827	SAHR-9328	12
GREEN	SAHS-9828	SAHR-9335	12
HIGH-VIZ ORANGE	SAHS-9835	SAHR-9369	12



# SAFETY EYEWEAR

## DB2 ADVANCED EYEWEAR



- High-impact polycarbonate lens
- 99.9% UV Protection
- Scratch-resistant lens
- Foam brow guard and non-slip temples, nose piece
- Meets ANSI Z87.1-2015

PART NO	DESCRIPTION
SAFT-0919	IRIDIUM LENS / GOLD FRAME
SAFT-0519	ICE BLUE LENS / SILVER FRAME
SAFT-0610	CLEAR LENS / BLACK FRAME

## COMMANDO CAMO EYEWEAR

- Hard coated polycarbonate lens
- Integrated rubber temples
- Scratch resistant
- High impact
- Meets the requirements of ANSI Z87.1



PART NO	DESCRIPTION
SAFT-8615	GRAY LENS / WALNUT CAMO FRAME
SAFT-8616	AMBER LENS / CAMO FRAME

## NSX TURBO ECONOMY EYEWEAR



- High-impact polycarbonate lens
- 99.9% UV Protection
- Scratch resistant coating
- Single lens design
- Lightweight wrap-around lens
- Meets ANSI Z87.1-2015

PART NO	DESCRIPTION
SAFT-5330	CLEAR ECONOMY
SAFT-5331	DARK TINTED ECONOMY
SAFT-5332	AMBER TINTED ECONOMY
SAFT-5333	LIGHT BLUE TINTED ECONOMY



# VOICE & DATA

## RJ11 TELEPHONE WALL PLATES

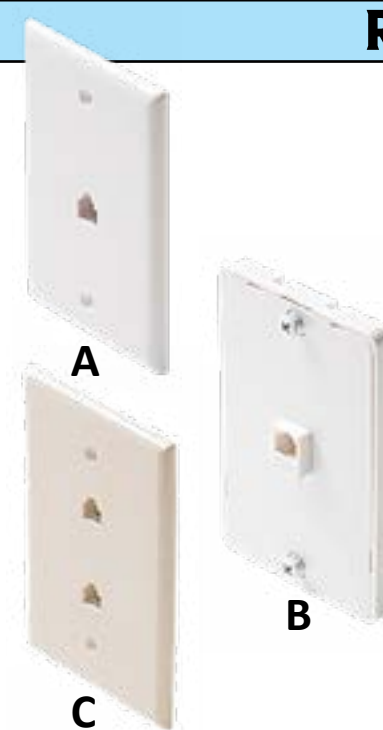

Modular telephone (6P4C) standard wall plate High-impact ABS Plastic Gold-plated contacts Flush-mount smooth finish Matching color mounting screws.

PART NO	MODEL	COLOR	DESCRIPTION	PACK
TTPW-4000	A	WHITE	4COND SMOOTH	10
TTPV-4000	A	IVORY	4COND SMOOTH	10
TTPA-4000	A	ALMOND	4COND SMOOTH	10
TTPL-4000	A	LT ALMOND	4COND SMOOTH	10

TTW-4000	B	WHITE	4COND WALL MOUNT	10
TTV-4000	B	IVORY	4COND WALL MOUNT	10

TTPW-4200	C	WHITE	4COND DUPLEX SMOOTH	10
TTPV-4200	C	IVORY	4COND DUPLEX SMOOTH	10
TTPA-4200	C	ALMOND	4COND DUPLEX SMOOTH	10
TTPL-4200	C	LT ALMOND	4COND DUPLEX SMOOTH	10

## RJ11 / F81 COMBO WALL PLATES



- Common 6P4C (RJ11) telephone jack paired with an F81 Coaxial Splice
- High-impact ABS plastic
- Flush-mount smooth finish

PART NO	MODEL	COLOR	DESCRIPTION	PACK
TTPW-8140	E	WHITE	4COND TEL/COAX SMOOTH	10
TTPV-8140	E	IVORY	4COND TEL/COAX SMOOTH	10

## DECOR RJ11 TELEPHONE WALL PLATES

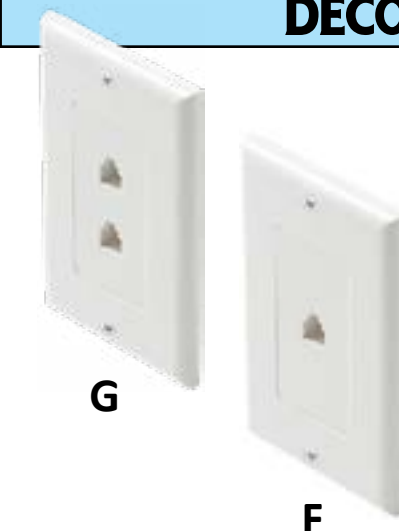

Single-gang decorator-Style flush plate Mounts in standard electrical boxes Includes cover plate and jack assembly High-impact ABS plastic mounting bracket Gold-plated contacts Matching color mounting screws.

PART NO	MODEL	COLOR	DESCRIPTION	PACK
TTDW-4000	F	WHITE	4COND 1 GANG	10
TTDV-4000	F	IVORY	4COND 1 GANG	10

TTDW-4200	G	WHITE	4COND DUPLEX	10
TTDV-4200	G	IVORY	4COND DUPLEX	10

TTDW-8140	N/S	WHITE	4COND TEL/COAX	10
TTDV-8140	N/S	IVORY	4COND TEL/COAX	10





# VOICE & DATA

## IDC CONNECTORS



Available in a variety of contact styles for splicing telecom/telephone wiring, tapping existing wiring, or joining wires of different wire gauges, these connectors provide a moisture resistant barrier for reliable connections. Butt splice connectors are easy to use, and are ideal for many types of cable splicing. Operating temperature: -22°F to 158°F (-30°C to 70°C).

PART NO	MODEL	COLOR	DESCRIPTION	WIRE	PACK
TTUR-1000-JR	A	RED	UR 3-WIRE	22-26	100/JAR
TTUR-2000-JR	B	RED	UR2 3-WIRE	19-26	100/JAR
TTUY-1000-JR	C	YELLOW	UY 2-WIRE	22-26	100/JAR
TTUG-1000-JR	D	GREEN	UG TAP/RUN	22-26	100/JAR
TTUB-1000-JR	E	BLUE	UB TAP/RUN	22-26	50/JAR

## RJ11 6P4C CONNECTORS - VOICE



Crimp on RJ11 connectors for 4 Conductor Solid Wires

PART NO	DESCRIPTION	WIRE	PACK
TTPF-4006	RJ11 6P4C CONNECTOR FOR FLAT WIRE	24-26	100/JAR
TTPR-4006	RJ11 6P4C CONNECTOR FOR ROUND WIRE	24-26	100/JAR

## BEAN CONNECTORS



These B-Connectors are used to splice low voltage wires, and designed to accept up to four strands of solid or stranded 22 Solid Copper AWG wire unstripped. It is great for alarm and telephone wiring, phones, intercoms and, telecom, networking and installation of most communication curcuit equipment.

PART NO	DESCRIPTION	WIRE	PACK
TTBB-1000	BLUE GEL FILLED	19-26	100/JAR
TTBW-1000	WHITE DRY	19-26	100/JAR

## SPLITTERS AND SPLICES



PART NO	DESCRIPTION	PACK
TTCI-4000	RJ11 6P4C PHONE CABLE EXTENDER	EACH
TTBW-1000	RJ11 6P4C 1 FEMALE TO 2 FEMALE SPLITTER	EACH

## TOOLING



PART NO	DESCRIPTION	PACK
TLCP-6488	CRIMP TOOL FOR RJ11, RJ12 AND RJ45	EACH
TLPD-1000	PUNCH DOWN TOOL FOR 110/88 OR 66 BLOCKS	EACH



# VOICE & DATA

## F81 COAXIAL WALL PLATES

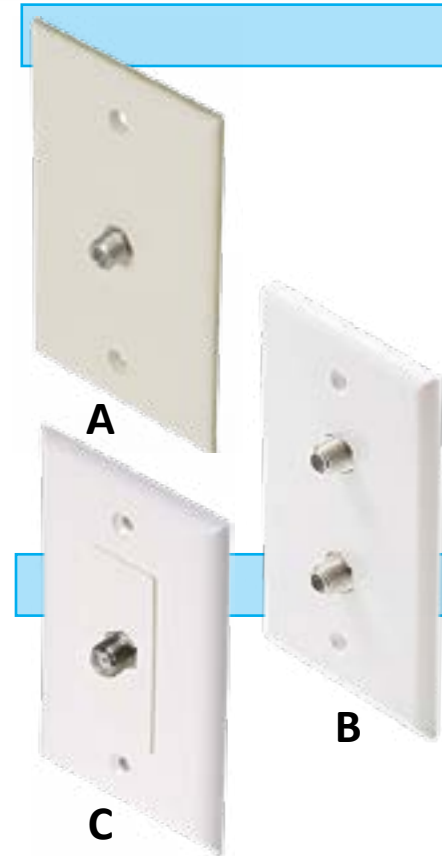

Modular telephone standard wall plate High-impact ABS Plastic Gold-plated contacts Flush-mount smooth finish Matching color mounting screws Dimensions: 2 3/4"(W) x 4 1/2"(H)

PART NO	MODEL	COLOR	DESCRIPTION	PACK
TTCW-4000	A	WHITE	F81 SMOOTH	10
TTCV-4000	A	IVORY	F81 SMOOTH	10
TTCA-4000	A	ALMOND	F81 SMOOTH	10
TTCL-4000	A	LT ALMOND	F81 SMOOTH	10
TTCW-8200	B	WHITE	DUPLEX F81 SMOOTH	10
TTCV-8200	B	IVORY	DUPLEX F81 SMOOTH	10

## DECORATOR F81 COAXIAL PLATES

PART NO	MODEL	COLOR	DESCRIPTION	PACK
TTDW-8100	C	WHITE	DECORATOR F81	10
TTDV-8100	C	IVORY	DECORATOR F81	10
TTDW-8200	N/S	WHITE	DUPLEX DECORATOR F81	10
TTDV-8200	N/S	IVORY	DUPLEX DECORATOR F81	10

## F TYPE COAXIAL SPLITTERS



F type coaxial splitters are designed to distribute incoming cable TV, digital cable and off-air signals to multiple locations. Each splitter features a die cast body that is configured with mounting tabs and ground screw.

TYPE	900MHZ	1GHZ 130dB (1000MHZ)	2.4GHZ 90dB (2400MHZ)	PACK
2 WAY	TTSP-0102	TTSP-1102	TTSP-2102	10
3 WAY	TTSP-0103	TTSP-1103		10
4 WAY	TTSP-0104	TTSP-1104	TTSP-2104	5
6 WAY	TTSP-0106	TTSP-1106		EACH
8 WAY	TTSP-0108	TTSP-1108		EACH

## F TYPE COAXIAL GROUNDING BLOCKS



This ground block is used to ground coax cables from a multi-switch, satellite dish or outdoor antenna. Used to ground and help protect fragile electronics such as satellite receivers and televisions from damaging lightning strikes and power surges.

PART NO	CONNECTIONS	DESCRIPTION	PACK
TTGB-8100	SINGLE	F-TYPE GROUNDING BLOCK	5
TTGB-8200	DOUBLE	F-TYPE GROUNDING BLOCK	5



# VOICE & DATA

## COMPRESSION F CONNECTORS



A

The Ridgeloc® Connector's textured sleeve cylinder and the end bell capture rings prevent backing up regardless if end bell is located in the sleeve. The coax is positively captured by the end bell every time.



B

PART NO	MODEL	DESCRIPTION	PACK
TTCP-6000	A	RG6 CONNECTOR	50/JAR
TTCP-6000-U	B	RG6/RG6-QUAD UNIVERSAL CONNECTOR	50/JAR



Compression Tool for RG59/6, compression length: 21mm. This is a heavy duty metal compressor tool for RG-6 F-connectors that have a compression depth of 21mm. Works great on any axially compressed F connector.



PART NO	DESCRIPTION
TLCP-1000	COMPRESSION TOOL FOR RG59 / RG6
TLCS-1000	COAXIAL JACKET STRIPPER RG59/RG6

## F CONNECTORS



A

PART NO	MODEL	DESCRIPTION	PACK
TTCB-8100-AP	A	F81 BARREL CONNECTOR	25/BOX
TTCB-8100-JR	A	F81 BARREL CONNECTOR	50/JAR



B

TTCC-6000-AP	B	RG6 F CRIMP CONNECTOR	25/BOX
TTCC-6000-JR	B	RG6 F CRIMP CONNECTOR	50/JAR
TTCC-5900-AP	B	RG59 F CRIMP CONNECTOR	25/BOX
TTCC-5900-JR	B	RG59 F CRIMP CONNECTOR	50/JAR



C

TTCS-6000-AP	C	RG6 F SCREW-ON CONNECTOR	25/BOX
TTCS-6000-JR	C	RG6 F SCREW-ON CONNECTOR	50/JAR



D

TTCQ-6000-AP	D	RG6 QUAD SHIELD F CRIMP CONNECTOR	25/BOX
TTCW-6000-JR	D	RG6 QUAD SHIELD FCRIMP CONNECTOR	50/JAR

## TOOLING



Crimp and stripping tooling designed for use with RG59, RG6 and RG6 Quad Shield (excluding TLCO-1000).



PART NO	DESCRIPTION
TLCO-1000	F CONNECTOR CRIMP TOOL RG6/RG59
TLCO-2000	F CONNECTOR CRIMP TOOL RG6/RG6 QUAD
TLCS-1000	COAXIAL JACKET STRIPPER RG59/RG6



# VOICE & DATA

## KEYSTONE PLATES



- Flush-mount keystone faceplate with four cavities
- High-impact ABS construction holds industry standard modular insert
- Accomodates CAT5, 5e, CAT6 and RJ11 keystone inserts
- Matching color mounting screws

CAVITY	WHITE	IVORY	PACK
1	TTKW-8001	TTKV-8001	10
2	TTKW-8002	TTKV-8002	10
3	TTKW-8003	TTKV-8003	10
4	TTKW-8004	TTKV-8004	10
6	TTKW-8006	TTKV-8006	10

## RJ45 8P8C KEYSTONE JACK



- 22-26 AWG 110-IDC Contacts
- UL94V-0 Thermoplastic ABS housing 180°

COLOR	CATEGORY 5/5e	CATEGORY 6	PACK
WHITE	TTRJ-4580-WH	TTRJ-4586-WH	10
IVORY	TTRJ-4580-IV	TTRJ-4586-IV	10
BLUE	TTRJ-4580-BL	TTRJ-4586-BL	10
GREEN	TTRJ-4580-GR		10
ORANGE	TTRJ-4580-OR	TTRJ-4586-OR	10
YELLOW	TTRJ-4580-YL		10
BLACK	TTRJ-4580-BK	TTRJ-4586-BK	10

## F81 COAXIAL KEYSTONE JACK



- Connector-module insert used with keystone wall plates
- Sturdy snap-in construction provides tamper-resistant protection

TYPE	WHITE	IVORY	PACK
KEYSTONE	TTKB-8100-WH	TTKB-8100-IV	10

## KEYSTONE BLANK



- Blanks can be snapped easily into compatible patch panels and wallplates
- Sturdy snap-in construction provides tamper-resistant protection
- Provides a neat, clean & professional looking installation in the home or office

TYPE	WHITE	IVORY	PACK
KEYSTONE	TTKI-1000-WH	TTKI-1000-IV	10





# VOICE & DATA

## RJ45 8P8C CONNECTORS AND STRAIN RELIEFS



- These crimp connectors are used to terminate a CAT-5 or CAT-5E cable
- 8-pin Gold-plated connections
- Easy-to-grasp retention clips

PART NO	DESCRIPTION	PACK
TTRJ-4500-JR	CAT 5 / 5E RJ45 CONNECTOR	100/JAR
TTRJ-4506-JR	CAT 6 RJ45 CONNECTOR	100/JAR



- RJ45 Boots Cover for RJ45 Connectors; Color: White
- Compatible Connectors: CAT5, CAT5e, CAT6

COLOR	PART NO	DESCRIPTION	PACK
BLUE	TTSL-4500-JR	RJ45 STRAIN RELIEF COVER	100/JAR
BLACK	TTSB-4500-JR	RJ45 STRAIN RELIEF COVER	100/JAR

## RJ45 8P8C SPLICE



- Modular Inline Coupler
- Joins two Ethernet cables together -- helps extend connections

PART NO	DESCRIPTION	PACK
TTCI-005E	CAT 5/5e SPLICE	5
TTCI-0060	CAT 6 SPLICE	5

## TOOLING



PART NO	DESCRIPTION
TLCP-6488	Crimp tool for RJ11, RJ12 and RJ45
TLPD-1000	Punch down tool for 110/88 or 66 Blocks
TLLT-4500	Network Cable Tester for Cat5 RJ45 RJ11 RJ12

## NETWORKING TOOL KIT



- Crimping tool for: 4P4C (RJ10), 6P4C (RJ11), 6P6C (RJ12), 8P8C (RJ45)
- LAN tester
- UTP/STP wire stripper & cutter
- Punch down tool with 66 & 110/88 blades
- 125 modular plugs: 50 x 6P6C, 50 x 4P4C, 25 x 8P8C

PART NO	DESCRIPTION
TLNK-0129	NETWORK TERMINATION KIT W/CASE



# CARGO SECURITY

## ROPE RATCHET TIE-DOWN



Each ROPE RATCHET is made super tough to take all the hard work you do. The outer casings are made from #6 - 33% Glass Filled Nylon with interior mechanisms of Die Cast Zinc. The rope is Solid Braided Polyester or Polypropylene and the hooks are Zinc Plated Steel.

With the ROPE RATCHET you simply attach the two hooks and pull the loose end of the rope for a secure, tight hold. ROPE RATCHETS stay tight, locking in place as you pull the free end. To loosen you just pull the rope to reduce tension and push the handy thumb release. It's that easy!

PART NO	DESCRIPTION	QTY PACK
CGRR-1408	1/4" RATCHET W/ 8FT ROPE	1
CGRR-3808	3/8" RATCHET W/ 8FT ROPE	1
CGRR-3815	3/8" RATCHET W/ 15FT ROPE	1
CGRR-1215	1/2" RATCHET W/ 15FT ROPE	1



## RATCHET STRAPS



These durable ratchet tie downs feature a new comfortable ergonomic molded rubber grip. The webbing is UV treated for direct sun durability. The polyester webbing has very low elasticity for minimum tie-down stretching. All steel parts are heat treated for additional strength. Our ratchet tie downs have plenty of uses such as moving, travel, camping, building materials, power sports, motorcycles, ATV, 4x4, quad, trailer, mountain bikes, snowmobiles, scooters, lawnmowers, jet skis, boats and anything else under the sun that needs to be tied down and tightly secured.

PART NO	DESCRIPTION	LENGTH	WIDTH	CAPACITY	QTY PACK
CGRT-7200	HEAVY DUTY (BLUE/SILVER)	6FT	1"	600LBS	2
CGRT-8400	SUPER DUTY (GREEN/SILVER)	14FT	1"	1000LBS	2
CGRT-1701	MEGA DUTY (YELLOW/GOLD)	15FT	1-1/2"	1830LBS	1

## CARGO SECURITY KIT BOX



This set contains various sizes of bungee cords, bungee ties, ratchet tie-down straps and regular tie-down straps all conveniently stored in a durable, clear plastic container. Contains 20 pcs plus case.

PART NO	DESCRIPTION
CGTB-1000	ASSORTED TRUCK BOX





# CARGO SECURITY

## BUNGEE CORD ASSORTMENTS



- Heavy Duty Bungee Cords feature molded hooks to prevent rusts and corrosion
- Coated steel hooks have extra wide openings to improve fit and performance
- Color coded by cord size

PART NO	DESCRIPTION	PCS/JAR
CGBG-8600	ASSORTED LENGTHS - STANDARD DUTY	12
CGBG-8400	ASSORTED LENGTHS - STANDARD DUTY	24
CGBG-2500	ASSORTED LENGTHS - TRIPLE STRENGTH	10

## EPDM HEAVY DUTY RUBBER TIE-DOWNS

Ozone-resistant multipurpose EPDM tarp straps are designed to be used in outdoor applications; won't rot or lose stretchability when left out in the elements. Include S-hooks on both ends.



PART NO	DESCRIPTION	PCS/BOX
CGTD-1510	EPDM RUBBER TIE DOWN 15"	10
CGTD-2105	EPDM RUBBER TIE DOWN 21"	5
CGTD-3105	EPDM RUBBER TIE DOWN 31"	5

## HEAVY DUTY TARPS



Tarp is lightweight yet durable, manufactured from high-density polyethylene and woven into black fabric and then laminated silver on both sides then finished by hemming the edges with poly twine inserted in hem. All seams and hems are heat sealed. UV treated for

PART NO	DESCRIPTION
TARP-0810	SILVER HD TARPAULIN 8FT X 10FT
TARP-1012	SILVER HD TARPAULIN 10FT X 12FT
TARP-1216	SILVER HD TARPAULIN 12FT X 16FT
TARP-1620	SILVER HD TARPAULIN 16FT X 20FT

## SECURING YOUR LOAD WITH RATCHET STRAPS

Ratchet straps use a mechanically geared, slotted drum and a crank handle to tension the strap. Once the webbing is threaded through the slotted drum, the crank handle is used to take up the slack and tension the strap to the required level. The ratchet lever is then moved to the "closed position". It is crucial that there is at least one complete winding of the webbing around the drum since this type of mechanism relies on the friction between the wound layers of webbing to keep the webbing from slipping through the slot when under tension. Too many wraps of webbing around the drum may cause the mechanism to jam. Releasing the tension is a simple matter of pulling the center latch and moving the ratchet crank handle to the "open" position and pulling the webbing back through the slotted drum.



Visit us on the web at  
[www.posi-tech.com](http://www.posi-tech.com)



# RAZOR KNIVES

## KUTTO - THE ORIGINAL SAFETY BOX CUTTER

Kutto© Master Carton Cutter Perfect for box top trimming, tray packing and carton splitting. Made of heavy gauge, zinc-plated steel insuring years of heavy use. Safety design allows blade to fully retract and remain secure at any depth.



PART NO	DESCRIPTION
KUTT-020R	RIGHT HANDED - INCLUDES SIX BLADES
KUTT-020L	LEFT HANDED - INCLUDES SIX BLADES
KUTT-0K17	REPLACEMENT BLADES 5/PACK

## SIMPLE BOX CUTTER



PART NO	DESCRIPTION
TLRZ-1000	ECONOMY BOX CUTTER
TLRZ-0005	REPLACEMENT BLADES

## TURBO X KNIFE™ - RETRACTABLE RAZOR KNIFE

The Turbo X Knife™ is the next generation of Utility Knives. The blade retracts and locks in 10 different positions to accommodate various projects. The non-slip, soft touch finish is comfortable and the ergonomic design offers a comfortable grip. Single hand slide-action operation with open/close lock and quick change mechanism.



PART NO	DESCRIPTION
TBKN-0130	GREEN CAMOUFLAGE
TBKN-0132	SOLID RED
TBKN-0133	SOLID ORANGE
TBKN-0134	SOLID BLUE
TLUB-0005	REPLACEMENT UTILITY BLADE

## TURBOFOLD™ - FOLDING RAZOR KNIFE

The Turbofold folding knife is an enhanced version of the traditional folding razor knife that has been used successfully for decades now. This edition adds a 5 position locking blade and quick blade release dial. A diverse selection of color patterns ensures that your Turbofold won't be mistaken for others on the jobsite.



PART NO	COLOR/PATTERN
TLRZ-0204	GREEN CAMOUFLAGE
TLRZ-0207	ORANGE CAMOUFLAGE
TLRZ-0208	PINK CAMOUFLAGE
TLRZ-0209	DIGITAL GREY CAMOUFLAGE
TLRZ-0210	SNOW CAMOUFLAGE
TLRZ-0200	SOLID BLACK
TLUB-0005	REPLACEMENT UTILITY BLADE





# TOOLS AND SUPPLIES

## UGLYS ELECTRICAL REFERENCE SERIES



Offering the most pertinent information used by electricians, including: mathematical formulas, National Electrical Code tables, wiring configurations, conduit bending, ampacity and conduit fill information, and life-saving first aid procedures.

PART NO	DESCRIPTION	ISBN	YEAR
BKUG-2017	UGLY'S ELECTRICAL REFERENCES	978-1-284-11936-7	2017
BKUG-2017-EM	UGLY'S ELECTRIC MOTORS AND CONTROLS	978-1-284-11942-8	2017
BKUG-2017-CB	UGLY'S CONDUIT BENDING	978-1-284-11944-2	2017
BKUG-2017-70E	UGLY'S ELECTRICAL SAFETY AND NFPA 70E	978-1-284-11940-4	2017
BKUG-2017-RW	UGLY'S RESIDENTIAL WIRING	978-1-284-11947-3	2017

## PVC SAWS / CUTTERS



PART NO	FIG	DESCRIPTION	MAX SIZE
TLPC-0500	1	ECONOMY CABLE CUTTER	8"
TLPC-1000	2	RATCHETING CUTTER	1-5/8"
TLPC-2000	3	RATCHETING CUTTER	2-1/2"
TLPC-3000	4	HAND SAW	10"



Visit us on the web at [www.posi-tech.com](http://www.posi-tech.com)



# TOOLS AND SUPPLIES

## CONDUIT BENDING LEVELS



This tool is indispensable if you want to bend precision offsets, saddles, and stubs without dog legs or wows. The "wow-watcher" or no-dog is constructed of Vertron, a space age material made of fiberglass and nylon compounds. This combination of materials provides a tough, yet lightweight tool. A thumb screw with a brass insert is used for securing the device to any type of conduit, in sizes 1/2" through 6". The precision straight bubble vial is used so the tool can accurately indicate level in all positions.

PART NO	DESCRIPTION
LEVL-1000	ECONOMY CONDUIT LEVEL

## SAVAGE™ CONDUIT BENDING LEVELS



The SAVAGE™ Aluminum Torpedo Levels are equipped with the most innovative and time-saving features of any level on the market today, all in one pocket-sized, lightweight tool – perfect for contractors and electrical and plumbing professionals. The Savage™ and Lil' Savage™ levels are made of precision-machined, solid-billet aluminum alloy, anodized for maximum durability.

PART NO	DESCRIPTION	LENGTH
LEVL-2000	SAVAGE TORPEDO LEVEL W/CONDUIT CLAMP	6 INCH
LEVL-3000	SAVAGE TORPEDO LEVEL	9 INCH



## BATTERIES

The Rayovac ultra pro alkaline batteries are the smart choice for your battery powered devices because they last as long as other leading brands, but cost less.



PART NO	DESCRIPTION	PACK
AAA	AAA ALKALINE	24
AA	AA ALKALINE	24
C	C ALKALINE	12
D	D ALKALINE	12
9V	9V ALKALINE	8



# HOLE SAW BLADES



Use High Speed Steel saws with varied cutting teeth for easily cut materials, such as unalloyed steel (up to 101,521 psi strength), non-ferrous and light metals, plastics, plasterboard and light building boards, fiberboard, plywood and wood.

- Alloyed steel 6135 jacket
- Cutting depth up to 1-1/2"
- High rotational precision
- Sturdy construction
- Welded HSS teeth
- 5 teeth per inch



## PILOT BIT



PART NO	DESCRIPTION
DBPB-0014	1/4" ARBOR

PART NO	SIZE	FOR PIPE SIZE	ARBOR THREAD
SOBS-0062	5/8"		1/2"-20
SOBS-0075	3/4"	3/8"	1/2"-20
SOBS-0087	7/8"	1/2"	1/2"-20
SOBS-0100	1"		1/2"-20
SOBS-0112	1-1/8"	3/4"	1/2"-20
SOBS-0125	1-1/4"		5/8"-18
SOBS-0137	1-3/8"	1"	5/8"-18
SOBS-0150	1-1/2"		5/8"-18
SOBS-0162	1-5/8"		5/8"-18
SOBS-0175	1-3/4"	1-1/4"	5/8"-18
SOBS-0187	1-7/8"		5/8"-18
SOBS-0200	2"	1-1/2"	5/8"-18
SOBS-0212	2-1/8"		5/8"-18
SOBS-0225	2-1/4"		5/8"-18
SOBS-0237	2-3/8"		5/8"-18
SOBS-0250	2-1/2"	2"	5/8"-18
SOBS-0262	2-5/8"		5/8"-18
SOBS-0275	2-3/4"		5/8"-18
SOBS-0300	3"	2-1/2"	5/8"-18
SOBS-0350	3-1/2"		5/8"-18
SOBS-0362	3-5/8"	3"	5/8"-18
SOBS-0375	3-3/4"		5/8"-18
SOBS-0400	4"		5/8"-18
SOBS-0412	4-1/8"	3-1/2"	5/8"-18
SOBS-0425	4-1/4"		5/8"-18
SOBS-0450	4-1/2"	4"	5/8"-18
SOBS-0475	4-3/4"		5/8"-18
SOBS-0500	5"		5/8"-18
SOBS-0550	5-1/2"		5/8"-18
SOBS-0562	5-5/8"	5"	5/8"-18
SOBS-0600	6"		5/8"-18
SOBS-0637	6-3/8"	6"	5/8"-18

## HOLE SAW ARBORS



PART NO	THREAD	SHANK	RANGE
TLHH-1238	1/2"-20	3/8"	9/16" - 1-3/16"
TLHH-1276	1/2"-20	7/16"	9/16" - 1-3/16"
TLHH-5838	5/8"-18	3/8"	1-1/4" - 6-3/8"
TLHH-5876	5/8"-18	7/16"	1-1/4" - 6-3/8"



# HOLE SAW KITS



PART NO	DESCRIPTION
SOKE-1000	ELECTRICIAN'S KIT 1 EA: 7/8", 1-1/8", 1-3/8", 1-3/4", 2", 2-11/16" 2 ARBORS
SOKM-1000	MASTER HOLE SAW KIT 5/8, 3/4, 13/16, 15/16, 1, 1-1/8, 1-1/4, 1-7/16, 1-9/16, 1-7/8, 2, 2-1/8, 2-3/8, 2-7/8, 3-1/4 2 ARBORS



# SAW BLADES

## HACKSAW BLADES



This HSS bi-metallic hacksaw blade is made of two different types of steel. The cutting edge is made of hard HSS molybdenum steel and the saw blade body is made of alloyed heat-treated steel. The combination of the two types of steel in one saw blade makes the hacksaw blade extremely wear-resistant, unbreakable and gives it outstanding cutting durability.

PART NO	TPI	QTY/PACK
SKBS-1812	18	10
SKBS-2412	24	10
SKBS-3212	32	10

## HACKSAW FRAMES



PART NO	DESCRIPTION
TLHK-1000	ECONOMY FULL FRAME
TLHK-2000	PREMIUM FULL FRAME

## RECIPROCATING SAW BLADES



HSS bimetal saw blades are the correct choice where the material to be cut and the conditions of use subject the saw-blade to extreme stresses. The teeth of the saw blade are made of HSS steel whereas the spine is made of a softer and more elastic HCS steel. This combination of materials makes the HSS bimetal saw blades highly flexible and gives them high cutting performance and long service life at the same time.

PART NO	LENGTH	WIDTH	TPI	QTY/PACK
SRBS-0663	6"	3/4"	6	5
SRBS-1063	6"	3/4"	10	5
SRBS-1463	6"	3/4"	14	5
SRBS-1863	6"	3/4"	18	5
SRBS-2463	6"	3/4"	24	5
SRBS-1083	8"	3/4"	10	5
SRBS-1483	8"	3/4"	14	5
SRBS-1883	8"	3/4"	18	5
SRBS-0613	12"	3/4"	6	5
SRBS-1113	12"	3/4"	10/14	5







# TWIST DRILLS

## FRACTIONAL - JOBBER LENGTH

**118° ECONOMY:** Optimal for for drilling aluminum, die cast alloys and sheet metals. Wide flutes and high spiral are conducive of good chip removal and require less thrust than conventional drills.

**135° BLACK AND GOLD:** The self-centering split point eliminates walking for accurate hole location. Black and Gold surface treated for use in hardened steels, increasing abrasion resistance and increase chip flow.

**135° COBALT:** Made from M35 cobalt steel, our cobalt twist drills are manufactured to National Aerospace standard 907. These drill bits display high red hardness, permitting speeds up to 30% greater than with conventional M2 high speed steel, and are especially effective in drilling tough, high tensile strength materials like stainless steel, inconel, and titanium.



118° ECONOMY BLACK OXIDE HSS

135° BLACK AND GOLD HSS

135° M35 COBALT STEEL

SIZE	135° SPLIT POINT	118° ECONOMY HSS	135° COBALT	LENGTH
1/16"	DBHS-0116-135	DBHS-0116	DBCO-0116	1-7/8"
5/64"	DBHS-0564-135	DBHS-0564	DBCO-0564	2"
3/32"	DBHS-0332-135	DBHS-0332	DBCO-0332	2-1/4"
7/64"	DBHS-0764-135	DBHS-0764	DBCO-0764	2-5/8"
1/8"	DBHS-0108-135	DBHS-0108	DBCO-0108	2-3/4"
9/64"	DBHS-0964-135	DBHS-0964	DBCO-0964	2-7/8"
5/32"	DBHS-0532-135	DBHS-0532	DBCO-0532	3-1/8"
11/64"	DBHS-1164-135	DBHS-1164	DBCO-1164	3-1/4"
3/16"	DBHS-0316-135	DBHS-0316	DBCO-0316	3-1/2"
13/64"	DBHS-1364-135	DBHS-1364	DBCO-1364	3-5/8"
7/32"	DBHS-0732-135	DBHS-0732	DBCO-0732	3-3/4"
15/64"	DBHS-1564-135	DBHS-1564	DBCO-1564	3-7/8"
1/4"	DBHS-0104-135	DBHS-0104	DBCO-0104	4"
17/64"	DBHS-1764-135	DBHS-1764	DBCO-1764	4-1/8"
9/32"	DBHS-0932-135	DBHS-0932	DBCO-0932	4-1/4"
19/64"	DBHS-1964-135	DBHS-1964	DBCO-1964	4-3/8"
5/16"	DBHS-0516-135	DBHS-0516	DBCO-0516	4-1/2"
21/64"	DBHS-2164-135	DBHS-2164	DBCO-2164	4-5/8"
11/32"	DBHS-1132-135	DBHS-1132	DBCO-1132	4-3/4"
23/64"	DBHS-2364-135	DBHS-2364	DBCO-2364	4-7/8"
3/8"	DBHS-0308-135	DBHS-0308	DBCO-0308	5"
25/64"	DBHS-2564-135	DBHS-2564	DBCO-2564	5-1/8"
13/32"	DBHS-1332-135	DBHS-1332	DBCO-1332	5-1/4"
27/64"	DBHS-2764-135	DBHS-2764	DBCO-2764	5-3/8"
7/16"	DBHS-0716-135	DBHS-0716	DBCO-0716	5-1/2"
29/64"	DBHS-2964-135	DBHS-2964	DBCO-2964	5-5/8"
15/32"	DBHS-1532-135	DBHS-1532	DBCO-1532	5-3/4"
31/64"	DBHS-3164-135	DBHS-3164	DBCO-3164	5-7/8"
1/2"	DBHS-0102-135	DBHS-0102	DBCO-0102	6"



# TWIST DRILLS

## NUMBERS - JOBBER LENGTH

Optimal for for drilling aluminum, die cast alloys and sheet metals. Wide flutes and high spiral are conducive of good chip removal and require less thrust than conventional drills.



SIZE	PART NUMBER	QTY PACK
#1	DBHS-0001	12
#2	DBHS-0002	12
#3	DBHS-0003	12
#4	DBHS-0004	12
#5	DBHS-0005	12
#6	DBHS-0006	12
#7	DBHS-0007	12
#8	DBHS-0008	12
#9	DBHS-0009	12
#10	DBHS-0010	12
#11	DBHS-0011	12
#12	DBHS-0012	12
#13	DBHS-0013	12
#14	DBHS-0014	12
#15	DBHS-0015	12
#16	DBHS-0016	12
#17	DBHS-0017	12
#18	DBHS-0018	12
#19	DBHS-0019	12
#20	DBHS-0020	12
#21	DBHS-0021	12
#22	DBHS-0022	12
#23	DBHS-0023	12
#24	DBHS-0024	12
#25	DBHS-0025	12
#26	DBHS-0026	12
#27	DBHS-0027	12
#28	DBHS-0028	12
#29	DBHS-0029	12
#30	DBHS-0030	12

SIZE	PART NUMBER	QTY PACK
#31	DBHS-0031	12
#32	DBHS-0032	12
#33	DBHS-0033	12
#34	DBHS-0034	12
#35	DBHS-0035	12
#36	DBHS-0036	12
#37	DBHS-0037	12
#38	DBHS-0038	12
#39	DBHS-0039	12
#40	DBHS-0040	12
#41	DBHS-0041	12
#42	DBHS-0042	12
#43	DBHS-0043	12
#44	DBHS-0044	12
#45	DBHS-0045	12
#46	DBHS-0046	12
#47	DBHS-0047	12
#48	DBHS-0048	12
#49	DBHS-0049	12
#50	DBHS-0050	12
#51	DBHS-0051	12
#52	DBHS-0052	12
#53	DBHS-0053	12
#54	DBHS-0054	12
#55	DBHS-0055	12
#56	DBHS-0056	12
#57	DBHS-0057	12
#58	DBHS-0058	12
#59	DBHS-0059	12
#60	DBHS-0060	12

## LETTERS - JOBBER LENGTH

SIZE	PART NUMBER	QTY PACK
SIZE A	DBHS-9901	6
SIZE B	DBHS-9902	6
SIZE C	DBHS-9903	6
SIZE D	DBHS-9904	6
SIZE E	DBHS-9905	6
SIZE F	DBHS-9906	6
SIZE G	DBHS-9907	6
SIZE H	DBHS-9908	6
SIZE I	DBHS-9909	6
SIZE J	DBHS-9910	6
SIZE K	DBHS-9911	6
SIZE L	DBHS-9912	6
SIZE M	DBHS-9913	6

SIZE	PART NUMBER	QTY PACK
SIZE N	DBHS-9914	6
SIZE O	DBHS-9915	6
SIZE P	DBHS-9916	6
SIZE Q	DBHS-9917	6
SIZE R	DBHS-9918	6
SIZE S	DBHS-9919	6
SIZE T	DBHS-9920	6
SIZE U	DBHS-9921	6
SIZE V	DBHS-9922	6
SIZE W	DBHS-9923	6
SIZE X	DBHS-9924	6
SIZE Y	DBHS-9925	6
SIZE Z	DBHS-9926	6



# TWIST DRILLS



## GATOR HIDE TWIST DRILL INDEX



Gator contractor grade twist drill index, from Posi-tech, is the most durable drill bit index available today. Constructed from high impact plastic.

- Shatterproof
- Weatherproof
- Convenient portability with molded belt clip

PART NO	DESCRIPTION
DBKJ-0290	118° HSS ECONOMY INDEX
DBKJ-0290-135	135° PREMIUM BLACK AND GOLD
DBKJ-0290-CO	135° COBALT

## TWIST DRILL INDEX KITS

- Each storage hole precisely sized for accurate, quick drill selection
- Compact design for easy storage
- Corrosion resistant, epoxy baked on coating
- Secure, snap-lock steel cover
- Rugged, heavy gauge all-steel case



PART NO	DESCRIPTION
DBKJ-0130	118° HSS ECONOMY INDEX 1/16" - 1/4" X 64THS - 13PCS
DBKJ-0150	118° HSS ECONOMY INDEX 1/16" - 1/2" X 32NDS - 15PCS
DBKJ-1290	118° HSS ECONOMY INDEX 1/16" - 1/2" X 64THS - 29PCS

Our 115 pc index includes all of our fractional, letter and number jobber length twist drills. Available in both economy 118° and premium 135° Black and Gold.

PART NO	DESCRIPTION
DBKJ-0115	118° ECONOMY COMPLETE INDEX - 115PCS
DBKJ-0115-135	135° BLACK AND GOLD COMPLETE INDEX - 115PCS

270PC, 29 compartment counter display - available completely stocked with any one of our three standard jobber length twist drill series.

PART NO	DESCRIPTION
DBCD-0029	118° HSS ECONOMY COUNTER DISPLAY
DBCD-0029-135	135° PREMIUM BLACK AND GOLD COUNTER DISPLAY
DBCD-0029-CO	135° COBALT COUNTER DISPLAY
DBCD-0290-DIY	EMPTY DISPLAY



# CUTTING TOOLS



## AIRCRAFT LENGTH TWIST DRILL - EXTRA LONG



12"

Manufactured to National Aerospace Standard 907. 135° split point is self-centering and reduces thrust. Ideal for drilling in mild steels where extra length for reach is required. They have a black oxide surface treatment that is abrasion resistant, reduces chip welding and improves chip flow. Sizes smaller than #52 and 1/16 have the 118° standard point.

SIZE	PART NO	LENGTH
3/16"	DBHS-0316-135-12	12"
1/4"	DBHS-0104-135-12	12"
5/16"	DBHS-0516-135-12	12"
3/8"	DBHS-0308-135-12	12"
1/2"	DBHS-0102-135-12	12"

## HAND TAPS - CARBON STEEL



Carbon Steel Hand Taps are used to re-thread damaged and/or jammed threads. Carbon Steel Hand Taps may also be used to thread mild steels.

- Taper Style - Starts the thread square with the workpiece
- Plug Style - Generally used in thru holes
- Bottom style - Generates the thread to the bottom of the hole

SIZE	PRE-DRILL SIZE	TAPER	PLUG	BOTTOM
6-32	#35	DBTT-0632	DBTP-0632	DBTB-0632
8-32	#29	DBTT-0832	DBTP-0832	DBTB-0832
10-24	#25	DBTT-1024	DBTP-1024	DBTB-1024
10-32	#21	DBTT-1032	DBTP-1032	DBTB-1032
12-24	#16	DBTT-1224	DBTP-1224	DBTB-1224
1/4-20	#7	DBTT-1420	DBTP-1420	DBTB-1420
5/16-18	F	DBTT-5618	DBTP-5618	DBTB-5618
3/8-16	5/16"	DBTT-3816	DBTP-3816	DBTB-3816
1/2-13	27/64"	DBTT-1213	DBTP-1213	DBTB-1213

## STEP DRILLS - TITANIUM COATED



Step drill bits are ideal for electrical, plumbing and HVAC contractors. Titanium-coated step drill bits remain clean and accurate even in the toughest materials; superior durability that lasts up to six times longer life than high-speed steel.

PART NO	STEPS	DESCRIPTION
DBUB-1805	13	1/8" - 1/2"
DBUB-3605	6	3/16" - 1/2"
DBUB-1407	9	1/4" - 3/4"
DBUB-3687	12	3/16" - 7/8"
DBUB-1412	3	1/4" - 1-1/8"
DBUB-7813	5	7/8" - 1-3/8"





# MASONRY DRILLS

## SMOOTH/ROUND SHANK



Engineered with wide flutes to provide fast dust removal in softer materials. Designed for drilling in brick, concrete, and sandstone. Carbide tips brazed to tough steel bodies and are larger than the nominal drill size to provide clearance for installation of anchor screws, expansion shields and toggle bolts. For use in portable electric drills.

DIAMETER	4"	6"	12"	18"
3/16"	DBMB-0316	DBMC-0316	DBMD-0316	DBME-0316
1/4"	DBMB-0104	DBMC-0104	DBMD-0104	DBME-0104
5/16"		DBMC-0516	DBMD-0516	DBME-0516
3/8"	DBMB-0308	DBMC-0308	DBMD-0308	DBME-0308
1/2"		DBMC-0102	DBMD-0102	DBME-0102
5/8"		DBMC-0508	DBMD-0508	DBME-0508
3/4"		DBMC-0304	DBMD-0304	DBME-0304
7/8"			DBMD-0708	DBME-0708
1"			DBMD-9000	DBME-9000

## SDS / SDS PLUS



SDS Carbide Tipped Drill Bits are designed for drilling stone or concrete. Carbide-tipped tools feature cutting edges of carbide for wear resistance and a steel shank for toughness.

DIAMETER	6"	12"	18"
5/32"	DBDS-5306		
3/16"	DBDS-3606		
1/4"	DBDS-1406		
5/16"	DBDS-5606		
3/8"	DBDS-3806	DBDS-3812	DBDS-3818
1/2"	DBDS-1206	DBDS-1212	DBDS-1218
5/8"		DBDS-5812	DBDS-5818
3/4"		DBDS-3412	DBDS-3418
7/8"		DBDS-7812	DBDS-7818
1"		DBDS-10012	DBDS-10018

## CONCRETE SCREW MASONRY BITS



Concrete screw drill bits feature a specially designed carbide tip that provides optimum pilot hole sizes for 3/16" and 1/4" concrete screws. DBTH series drill bits are designed with a tanged shank for use with installation tools.

LENGTH	FOR USE WITH LENGTHS	5/32"	3/16"
3-1/2"	1-1/4" - 1-3/4"	DBTH-0532	DBTH-0316
4-1/2"	2-1/4" - 2-3/4"	DBTH-1532	DBTH-1316
5-1/2"	3-1/4" - 4"	DBTH-2532	DBTH-2316
6-3/4"	5"		DBTH-3316



# WOOD BORING

## AUGER BITS

Durable hardened cutting edge for long life in tough materials. Fully-forged bit for maximum durability. Extra Wide flutes for maximum chip removal and less binding. Aggressive screw-pitch for faster drilling.



SIZE	PART NO
9/16"	DBSS-0916
5/8"	DBSS-0508
11/16"	DBSS-1116
3/4"	DBSS-0304
13/16"	DBSS-1316
7/8"	DBSS-0708
1"	DBSS-9000
1-1/8"	DBSS-9108
1-1/4"	DBSS-9104
1-3/8"	DBSS-9308
1-1/2"	DBSS-9102

SIZE	PART NO
9/16"	DBSL-0916
5/8"	DBSL-0508
11/16"	DBSL-1116
3/4"	DBSL-0304
13/16"	DBSL-1316
7/8"	DBSL-0708
1"	DBSL-9000
1-1/8"	DBSL-9108
1-1/4"	DBSL-9104
1-3/8"	DBSL-9308
1-1/2"	DBSL-9102

## NAIL BUSTER AUGER BITS

Nail buster auger drill bits are professional grade drill bits made to cut through nail-embedded wood. The drill bit comes with a self-feed screw point for fast drilling and are machined on a true center to prevent wobbling. A unique head makes it easy to resharpen.



SIZE	PART NO
9/16"	DBSS-0916-NE
5/8"	DBSS-0508-NE
11/16"	DBSS-1116-NE
3/4"	DBSS-0304-NE
13/16"	DBSS-1316-NE
7/8"	DBSS-0708-NE
1"	DBSS-9000-NE
1-1/8"	DBSS-9108-NE
1-1/4"	DBSS-9104-NE
1-3/8"	DBSS-9308-NE
1-1/2"	DBSS-9102-NE

SIZE	PART NO
9/16"	DBSL-0916-NE
5/8"	DBSL-0508-NE
11/16"	DBSL-1116-NE
3/4"	DBSL-0304-NE
13/16"	DBSL-1316-NE
7/8"	DBSL-0708-NE
1"	DBSL-9000-NE
1-1/8"	DBSL-9108-NE
1-1/4"	DBSL-9104-NE
1-3/8"	DBSL-9308-NE
1-1/2"	DBSL-9102-NE



# WOOD BORING

## SPADE BITS

Also known as paddle bits, these bits are commonly used for economical hole drilling in low density timbers. Equipped with a 1/4-inch hex shank, our paddle bits can be used in most common portable drills. 6" lengths.

SIZE	PART NO
1/4"	DBPS-0104
5/16"	DBPS-0516
3/8"	DBPS-0308
7/16"	DBPS-0716
1/2"	DBPS-0102
9/16"	DBPS-0916
5/8"	DBPS-0508
11/16"	DBPS-1116
3/4"	DBPS-0304

6"

SIZE	PART NO
13/16"	DBPS-1316
7/8"	DBPS-0708
15/16"	DBPS-1516
1"	DBPS-9000
1-1/8"	DBPS-9108
1-1/4"	DBPS-9104
1-3/8"	DBPS-9308
1-1/2"	DBPS-9102



- For Drilling Wood, Drywall, Plywood
- 6 Pc Spade Bit Set - (1 Pack)

PART NO	DESCRIPTION
DBPK-6000	SPADE BIT KIT 3/8"- 1/2"- 5/8" - 3/4"- 7/8"- 1"

## EXTENSION

For use with any 1/4" shank drill bit. Extends existing length by 12" for hard to reach places. Quick release shank for use with impact drivers or any adjustable chuck.



SIZE	PART NO
12"	DBPX-1000

### CHOOSING THE RIGHT DRILL BIT FOR WOOD

When choosing the proper drill bit for attacking your wood project, there are several factors to be considered. For small holes, under 1/4", a HSS twist drill is suitable for most applications. For low volume, larger holes, the spade bit (also known as a paddle bit) is an excellent choice. This is an economical means to drill holes up to 1-1/2" in pine and other softwoods. For repeated and rapid hole making, the auger bit is superior in every respect and will make short work of most construction timber. Available up to 18" in length, auger bits are sold in standard steel and high-grade steel for use in nail embedded timber.



# BITS AND DRIVERS

## PHILLIPS INSERT BITS

PART NO	SIZE	LENGTH
TLPH-1001	NO 1	1"
TLPH-2001	NO 2	1"
TLPH-3001	NO 3	1"



## PHILLIPS POWER BITS

PART NO	SIZE	LENGTH
TLPH-1002	NO 1	1-15/16"
TLPH-2002	NO 2	1-15/16"
TLPH-3002	NO 3	1-15/16"
TLPH-1003	NO 1	2-3/4"
TLPH-2003	NO 2	2-3/4"
TLPH-3003	NO 3	2-3/4"
TLPH-1004	NO 1	3-1/2"
TLPH-2004	NO 2	3-1/2"
TLPH-3004	NO 3	3-1/2"
TLPH-1006	NO 1	6"
TLPH-2006	NO 2	6"
TLPH-3006	NO 3	6"



## SLOT INSERT BITS

PART NO	SIZE	LENGTH
TLSL-0501	#4-#5	1"
TLSL-0801	#6-#8	1"
TLSL-1201	#8-#12	1"

## SOCKET ADAPTERS

Socket adapters will turn into one of your power drill into a high speed power nut driver

PART NO	DRIVE SIZE
TLSA-1402	1/4"
TLSA-3803	3/8"
TLSA-1203	1/2"

## SQUARE INSERT BITS

PART NO	SIZE	LENGTH
TLSX-1001	#1	1"
TLSX-2001	#2	1"
TLSX-3001	#3	1"



## SQUARE POWER BITS

PART NO	SIZE	LENGTH
TLSX-1002	#1	1-15/16"
TLSX-2002	#2	1-15/16"
TLSX-3002	#3	1-15/16"
TLSX-1003	#1	2-3/4"
TLSX-2003	#2	2-3/4"
TLSX-3003	#3	2-3/4"
TLSX-2006	#2	6"
TLSX-3006	#3	6"



## STAR INSERT BITS

PART NO	SIZE	LENGTH
TLTO-0801	#8	1"
TLTO-1001	#10	1"
TLTO-1501	#15	1"
TLTO-2001	#20	1"
TLTO-2501	#25	1"
TLTO-2701	#27	1"
TLTO-3001	#30	1"
TLTO-4001	#40	1"

## STAR POWER BITS

PART NO	SIZE	LENGTH
TLTO-0802	#8	2"
TLTO-1002	#10	2"
TLTO-1502	#15	2"
TLTO-2002	#20	2"
TLTO-2502	#25	2"
TLTO-2702	#27	2"
TLTO-3002	#30	2"
TLTO-4002	#40	2"





# BITS AND DRIVERS

## HEX DRIVERS / NUT SETTERS



DRIVE SIZE	LENGTH			
	1-3/4"	2-9/16"	4"	6"
1/4"	TLHX-1400	TLHX-1403	TLHX-1404	TLHX-1406
5/16"	TLHX-5600	TLHX-5603	TLHX-5604	TLHX-5606
3/8"	TLHX-3800	TLHX-3803	TLHX-3804	TLHX-3806
7/16"	TLHX-7600	TLHX-7603	TLHX-7604	TLHX-7606
1/2"	TLHX-1200	TLHX-1203	TLHX-1204	TLHX-1206
9/16"	TLHX-9600	TLHX-9603	TLHX-9604	TLHX-9606

### MAGNETIC BIT HOLDERS



PART NO	SIZE	LENGTH
TLBH-1000	1/4"	2"
TLBH-1006	1/4"	6"

### QUICK RELEASE BIT HOLDER



PART NO	SIZE	LENGTH
TLBH-2000	1/4"	2-3/8"



### STAR SECURITY BITS

PART NO	SIZE	LENGTH
TLSO-0802	#8	2"
TLSO-1002	#10	2"
TLSO-1502	#15	2"
TLSO-2002	#20	2"
TLSO-2502	#25	2"
TLSO-2702	#27	2"
TLSO-3002	#30	2"
TLSO-4002	#40	2"

### SECURITY BIT KITS



PART NO	DESCRIPTION
TPKT-0500	33PC MINI KIT
TPKT-1000	100PC PREMIUM KIT

### SPANNER SECURITY BITS



PART NO	SIZE	LENGTH
TLTO-0801	#8	1"
TLTO-1001	#10	1"
TLTO-1501	#15	1"
TLTO-2001	#20	1"
TLTO-2501	#25	1"



# RIGID STRAPS

## SNAP-ON ONE HOLE

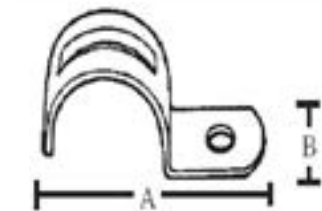

Our snap on style, one-hole rigid straps are crafted from highly resilient, Zinc plated steel and feature an inverted rib for added strength. Easy to install and available in a variety of sizes to suit multiple applications. Available in 1/2" to 4" sizes; supports both IMC and Rigid conduit.

SIZE	ELECTRO GALVANIZED	A	B	316 STAINLESS	A	B
1/4" (3/8" MC)	CSRC-1002	1.51"	.56"	C3RC-1002	1.51"	.56"
3/8"	CSRC-1003	1.81"	.56"	C3RC-1003	1.81"	.56"
1/2"	CSRC-1005	1.91"	.63"	C3RC-1005	1.91"	.63"
3/4"	CSRC-1007	2.21"	.75"	C3RC-1007	2.21"	.75"
1"	CSRC-1010	2.57"	.88"	C3RC-1010	2.57"	.88"
1-1/4"	CSRC-1012	2.79"	.88"	C3RC-1012	2.79"	.88"
1-1/2"	CSRC-1015	3.69"	.90"	C3RC-1015	3.69"	.90"
2"	CSRC-1020	4.17"	1.14"	C3RC-1020	4.17"	1.14"
2-1/2"	CSRC-1025	5.00"	1.28"	C3RC-1025	5.00"	1.28"
3"	CSRC-1030	5.55"	1.28"	C3RC-1030	5.55"	1.28"
3-1/2"	CSRC-1035	6.37"	1.28"	C3RC-1035	6.37"	1.28"
4"	CSRC-1040	6.87"	1.28"	C3RC-1040	6.87"	1.28"

## TWO HOLE



Our Two Hole rigid straps are crafted from highly resilient, zinc plated steel and feature an inverted rib for added strength. Easy to install and available in a variety of sizes to suit multiple applications.

SIZE	ELECTRO GALVANIZED	A	B	316 STAINLESS	A	B
1/2"	CSRC-2005	2.43"	.63"	C3RC-2005	2.43"	.63"
3/4"	CSRC-2007	2.81"	.69"	C3RC-2007	2.81"	.69"
1"	CSRC-2010	3.28"	.75"	C3RC-2010	3.28"	.75"
1-1/4"	CSRC-2012	4.02"	.88"	C3RC-2012	4.02"	.88"
1-1/2"	CSRC-2015	4.58"	1.00"	C3RC-2015	4.58"	1.00"
2"	CSRC-2020	5.22"	1.00"	C3RC-2020	5.22"	1.00"
2-1/2"	CSRC-2025	5.91"	1.00"	C3RC-2025	5.91"	1.00"
3"	CSRC-2030	6.71"	1.00"	C3RC-2030	6.71"	1.00"
3-1/2"	CSRC-2035	7.51"	1.00"	C3RC-2035	7.51"	1.00"
4"	CSRC-2040	8.31"	1.00"	C3RC-2040	8.31"	1.00"





# EMT STRAPS

## SNAP-ON ONE HOLE



One-hole EMT straps are crafted from highly resilient, Zinc plated steel and feature an inverted rib for added strength. Easy to install and available in a variety of sizes to suit multiple applications.

SIZE	ELECTRO GALVANIZED	A	B	304 STAINLESS	A	B
1/2"	CSTC-1005	1.79"	.57"	C2TC-1005	1.79"	.57"
3/4"	CSTC-1007	1.96"	.62"	C2TC-1007	1.96"	.62"
1"	CSTC-1010	2.25"	.75"	C2TC-1010	2.25"	.75"
1-1/4"	CSTC-1012	2.85"	.88"	C2TC-1012	2.85"	.88"
1-1/2"	CSTC-1015	3.16"	.99"	C2TC-1015	3.16"	.99"
2"	CSTC-1020	3.93"	1.10"	C2TC-1020	3.93"	1.10"

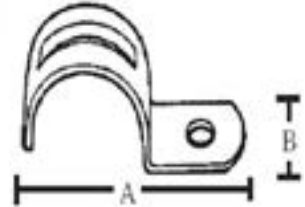

## TWO HOLE

Our Two Hole EMT straps are crafted from highly resilient, Zinc plated steel and feature an inverted rib for added strength. Easy to install and available in a variety of sizes to suit multiple applications.

SIZE	ELECTRO GALVANIZED	A	B	304 STAINLESS	A	B
1/2"	CSTC-2005	2.20"	.56"	C2TC-2005	2.20"	.56"
3/4"	CSTC-2007	2.67"	.62"	C2TC-2007	2.67"	.62"
1"	CSTC-2010	2.97"	.68"	C2TC-2010	2.97"	.68"
1-1/4"	CSTC-2012	3.67"	.75"	C2TC-2012	3.67"	.75"
1-1/2"	CSTC-2015	4.22"	.88"	C2TC-2015	4.22"	.88"
2"	CSTC-2020	4.91"	1.00"	C2TC-2020	4.91"	1.00"



## CONDUIT HANGERS

Our Conduit Hangers securely connect EMT or rigid conduit directly to mounting surface. Bolt features slotted Phillips head and nut. Fabricated from strong and long lasting steel with zinc plating

SIZE RIGID	ELECTRO GALVANIZED	316 STAINLESS	A	B	C	D
1/2"	CSHS-0505	C2HS-0505	1.88"	.75"	.73"	.25"
3/4"	CSHS-0707	C2HS-0707	2.13"	.75"	.85"	.25"
1"	CSHS-1010	C2HS-1010	2.44"	.875"	.98"	.25"
1-1/4"	CSHS-0012	C2HS-0012	2.75"	.875"	.98"	.25"
1-1/2"	CSHS-1215	C2HS-1215	3.13"	1.00"	1.13"	.25"
2"	CSHS-2020	C2HS-2020	3.88"	1.00"	1.15"	.25"
2-1/2"	CSHS-2525	C2HS-2525	4.63"	1.25"	1.23"	3.13"
3"	CSHS-3030	C2HS-3030	5.50"	1.25"	1.28"	3.13"
3-1/2"	CSHS-3535	C2HS-3535	5.75"	1.25"	1.28"	3.13"
4"	CSHS-4040	C2HS-4040	6.25"	1.25"	1.28"	3.13"

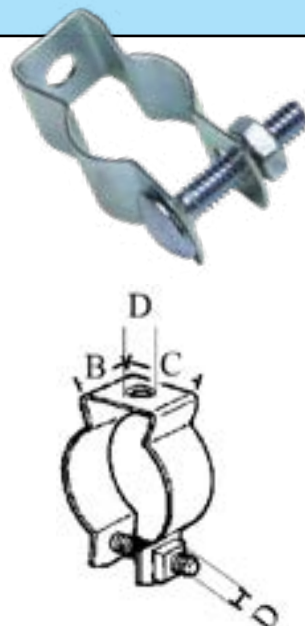

# PVC ACCESSORIES



## PVC TWO HOLE STRAPS



Features

- Two hole construction enables greater load bearing capacity
- Holes in the feet of the strap for mounting with screws or nails
- A U-shaped conduit support device used to anchor conduit to building surfaces
- Designed to handle the extra thickness of PVC conduit systems

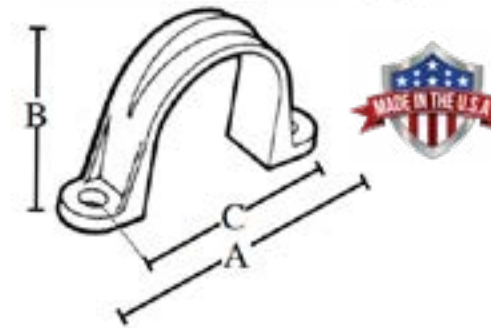

PART NO	SIZE	A	B	C
CSPC-2005	1/2"	2.19"	1.00"	1.69"
CSPC-2007	3/4"	2.50"	1.25"	2.00"
CSPC-2020	1"	2.81"	1.50"	2.00"
CSPC-2012	1-1/4"	3.16"	1.81"	2.50"
CSPC-2015	1-1/2"	3.38"	2.13"	2.69"
CSPC-2010	2"	4.00"	2.56"	3.31"
CSPC-2025	2-1/2"	5.50"	2.56"	4.56"
CSPC-2030	3"	6.00"	3.00"	5.13"
CSPC-2040	4"	7.00"	4.63"	6.00"

## ANTI SHORT BUSHINGS

Orbit Industries' anti-short circuit bushings are used to create insulating barriers against sharp edges of flexible metal conduits that have been cut in the field. They protect wires passing through flexible metal conduits. The bushings snap in place on the cut edge of flexible metal conduits. They help prevent short circuits and rework. In addition, they help ensure wires are protected from damage.



PART NO	SIZE	FLEX SIZE
ASBU-0	0	5/16"
ASBU-1	1	3/8"
ASBU-2	2	7/16"
ASBU-3	3	1/2"
ASBU-4	4	3/4"

## NMC CONNECTORS

Non-metallic snap style connectors are smaller and more easily installed in confined and tight areas. No tools required, just snap in and you're done. Easily removed from knockouts and easy removal of NMC from connectors.



PART NO	SIZE	LENGTH
TLSO-0802	#8	2"
TLSO-1002	#10	2"

Visit us on the web at [www.posi-tech.com](http://www.posi-tech.com)







# NM STAPLES

## NMSC STAPLES

### FOR WOOD AND LOW DENSITY SUBSTRATES



- Secures NM or UF Cable to wood structural members or low density substrates
- Nail heads are recessed for minimum exposure
- UV-resistant polyethylene saddle will not rust, rot or deteriorate

PART NO	SIZE	APPLICATION	COLOR	PACKAGE
PSRX-0050-CL	1/2"	14/2, 12/2, 10/2	WHITE	100/BAG
PSRX-0050-JR	1/2"	14/2, 12/2, 10/2	WHITE	100/JAR

PSRX-0075-CL	3/4"	14/3, 12/3, 10/3	WHITE	100/BAG
PSRX-0075-JR	3/4"	14/3, 12/3, 10/3	WHITE	100/JAR

## NMSC STACKING STAPLES

### FOR WOOD AND LOW DENSITY SUBSTRATES



- Secure combinations of NM and UF cable to wood structural members and low density substrates
- UV-resistant polyethylene saddle will not rust, rot or deteriorate

PART NO	SIZE	APPLICATION	COLOR	PACKAGE
PSTK-0002	1/2"	QTY 2 - 14/2 OR 12/2	WHITE	100/BAG
PSTK-0003	1/2"	QTY 3 - 14/2 OR 12/2	WHITE	100/BAG
PSTK-0004	1/2"	QTY 4 - 14/2 OR 12/2	WHITE	100/BAG

## NMSC STAPLES FOR BLOCK AND MASONRY

- Secures NM or UF Cable to cement block, mortar or plaster surfaces
- Hardened steel nails
- UV-resistant polyethylene saddle will not rust, rot or deteriorate



PART NO	SIZE	APPLICATION	COLOR	PACKAGE
PSMX-0050-CL	1/2"	14/2, 12/2, 10/2	WHITE	100/BAG
PSMX-0050-JR	1/2"	14/2, 12/2, 10/2	WHITE	100/JAR

PSMX-0075-CL	3/4"	14/3, 12/3, 10/3	WHITE	100/BAG
PSMX-0075-JR	3/4"	14/3, 12/3, 10/3	WHITE	100/JAR

## NMSC MULTICABLE STAPLES



- MultiCable Staples organize and secure multiple cable runs on a stud
- Secures NMSC, coaxial and CAT 5 all on the same staple
- Snap lock gate quickly and easily secures all cables
- Self-centering tab guides perfect placement on the stud
- Easy installation with one nail for wood studs or one screw for metal studs (fasteners included)
- Polypropylene material is flame retardant

Cable Combinations: (8) NM-B Flat 14-2 | (8) NM-B Flat 12-2 | (4) NM-B Flat 10-2  
(2) NM-B Round 14-3 | NM-B Round 12-3 | (10) RG-59 | (8) RG-6 | (10) Cat-5

PART NO	PACKAGE
STCK-0400-AL	25/BAG
STCK-0400-BK	100/BOX



# NM STEEL STAPLES

## FOR USE WITH UF AND NMSC CABLES



Graphite Metallic Steel Staples are designed to secure NMSC cables. These straight-driving, burr free, steel staples feature sharper tips so the legs drive in straight without splitting wood and have recessed heads to protect cable jackets. Virtually oil-free for cleaner handling and engineered to contractor preferred length. Designed to be driven into wood with a hammer.

PART NO	SIZE W	SIZE L	CONDUCTOR	QTY	PACK
STPL-1005-CK	1/2"	1"	14/2, 12/2, 10/2	100	BOX
STPL-1005-JR	1/2"	1"	14/2, 12/2, 10/2	100	JAR
STPL-1005-DK	1/2"	1"	14/2, 12/2, 10/2	500	BOX
STPL-1005-JRD	1/2"	1"	14/2, 12/2, 10/2	500	JAR
STPL-1005-BU	1/2"	1"	14/2, 12/2, 10/2	5000	BUCKET

STPL-1256-CK	9/16"	1-1/4"	14/3, 12/3, 10/3	100	BOX
STPL-1256-JR	9/16"	1-1/4"	14/3, 12/3, 10/3	100	JAR
STPL-1256-DK	9/16"	1-1/4"	14/3, 12/3, 10/3	500	BOX
STPL-1256-JRD	9/16"	1-1/4"	14/3, 12/3, 10/3	500	JAR
STPL-1256-BU	9/16"	1-1/4"	14/3, 12/3, 10/3	5000	BUCKET

## INSULATED - FOR USE WITH UF AND NMSC CABLES



Insulated Graphite Metallic Steel Staples are designed to secure NMSC cables. These straight-driving, burr free, steel staples feature sharper tips so the legs drive in straight without splitting wood and have recessed heads to protect cable jackets. Virtually oil-free for cleaner handling and engineered to contractor preferred length. Designed to be driven into wood with a hammer.

PART NO	SIZE W	SIZE L	CONDUCTOR	QTY	PACK
STPI-1005-CK	1/2"	1"	14/2, 12/2, 10/2	100	BOX
STPI-1005-JR	1/2"	1"	14/2, 12/2, 10/2	100	JAR

STPI-1256-CK	9/16"	1-1/4"	14/3, 12/3, 10/3	100	BOX
STPI-1256-JR	9/16"	1-1/4"	14/3, 12/3, 10/3	100	JAR

## SE/SEU/BX STEEL STAPLES



Attach large diameter cable to wood surfaces with our SE/SEU/BX staples. These staples feature offset legs to prevent wood splitting and a diamond head for easy hammering.

PART NO	SIZE W	SIZE L	CONDUCTOR	QTY	PACK
STPL-1307-CK	13/16"	1-3/8"	SEU 6/3 w/GROUND	100	BOX
STPL-1307-JR	13/16"	1-3/8"	SEU 6/3 w/GROUND	100	JAR

STPL-1516-CK	1-1/8"	1-1/2"	4/3 OR 2/3 SE CABLE	100	BOX
STPL-1516-JR	1-1/8"	1-1/2"	4/3 OR 2/3 SE CABLE	100	JAR

STPL-2115-CK	1-5/8"	2-1/8"	4/0 SE, BX, FLEX	100	BOX
STPL-2115-JR	1-5/8"	2-1/8"	4/0 SE, BX, FLEX	100	JAR



# CABLE STAPLES / NAILS

## SER/SEU PLASTIC STAPLES



SER

- Secures 2/3 SER cable to wood
- Zinc plated nails provide rust and corrosion resistance and provide a smooth finish
- Grey plastic saddle holds and protects the cable
- Sharp points for easy installation

PART NO	CONDUCTOR	QTY	PACK
PSER-0603-XL	6-3 SER W/GROUND	10	BAG
PSER-0603-AK	6-3 SER W/GROUND	25	BOX

PSEU-0602-XL	6-2 SEU W/GROUND	10	BAG
PSEU-0602-AK	6-2 SEU W/GROUND	25	BOX

PSER-0203-XL	2-3 SER W/GROUND	10	BAG
PSER-0203-AK	2-3 SER W/GROUND	25	BOX

PSEU-0202-XL	2-2 SEU W/GROUND	10	BAG
PSEU-0202-AK	2-2 SEU W/GROUND	25	BOX

PSER-2003-XL	2/0-3 SER W/GROUND	10	BAG
PSER-2003-AK	2/0-3 SER W/GROUND	25	BOX

PSEU-4002-XL	4/0-2 SER W/GROUND	10	BAG
PSEU-4002-AK	4/0-2 SER W/GROUND	25	BOX

PSER-4003-XL	4/0-3 SER W/GROUND	10	BAG
PSER-4003-AK	4/0-3 SER W/GROUND	25	BOX



SEU

## SINKER GENERAL CONSTRUCTION NAIL

For construction, carpentry and framing. Checkered countersunk head designed to sink flush with surface. Vinyl-coated smooth shank for easier nailing and firmer holding power. Made to conform to ASTM F1667.

Sold by the box - 1lb each

PART NO	PENNY	LENGTH	APPROX COUNT/LB
BCNL-005D	5D	1-5/8"	387
BCNL-006D	6D	1-7/8"	293
BCNL-007D	7D	2-1/8"	223
BCNL-008D	8D	2-3/8"	153
BCNL-010D	10D	2-7/8"	111
BCNL-012D	12D	3-1/8"	81
BCNL-016D	16D	3-1/4"	64
BCNL-020D	20D	3-3/4"	40



Visit us on the web at  
[www.posi-tech.com](http://www.posi-tech.com)



# LOW VOLTAGE STAPLES

## FOR USE WITH RG-59 & RG-6 CABLES



- For securing RG-59 and RG-6 coaxial cables
- Polyethylene saddle resists UV damage for indoor and outdoor use
- Smooth saddle helps prevent damage to insulation

### WOOD AND LOW DENSITY SUBSTRATES

PART NO	NAIL	COLOR	QTY	PACK
PSRG-0596-W	WOOD	WHITE	100	BAG
PSRG-0596-B	WOOD	BLACK	100	BAG

### BLOCK AND MASONRY

PART NO	NAIL	COLOR	QTY	PACK
PSMG-0596-W	MASONRY	WHITE	100	BAG
PSMG-0596-B	MASONRY	BLACK	100	BAG

## BELL, THERMOSTAT, SPEAKER AND PHONE



- For securing bell, speaker, thermostat and telephone wire
- UV resistant polyethylene saddles will not rust, rot or deteriorate
- Smooth saddle helps prevent damage to insulation

### WOOD AND LOW DENSITY SUBSTRATES

PART NO	NAIL	COLOR	QTY	PACK
PSBL-0596-W	WOOD	WHITE	100	BAG
PSBL-0596-B	WOOD	BLACK	100	BAG

### BLOCK AND MASONRY

PART NO	NAIL	COLOR	QTY	PACK
PSML-0596-W	MASONRY	WHITE	100	BAG
PSML-0596-B	MASONRY	BLACK	100	BAG

## RJ11, RJ12, RJ45, CATEGORY 4 & 5



- For securing RJ45, RJ11 AND RJ12
- UV-resistant polyethylene saddle construction
- Suitable for indoor and outdoor use
- Smooth saddle helps prevent damage to insulation

### WOOD AND LOW DENSITY SUBSTRATES

PART NO	NAIL	COLOR	QTY	PACK
PSRG-0596-W	WOOD	WHITE	100	BAG
PSRG-0596-B	WOOD	BLACK	100	BAG

### BLOCK AND MASONRY

PART NO	NAIL	COLOR	QTY	PACK
PSMG-0596-W	MASONRY	WHITE	100	BAG
PSMG-0596-B	MASONRY	BLACK	100	BAG





# THREADED ROD AND CLAMPS

## ZINC PLATED - ASTM A36 STEEL

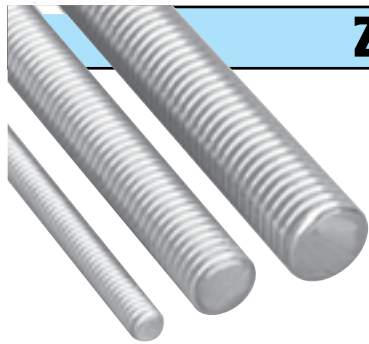

Low carbon steel, zinc plated fully threaded rod is used in construction, plumbing, heating and electrical for hanging, mounting, bracing and supporting.

THREAD	6FT	10FT	MAX LOAD	PCS/FT TUBE
1/4-20	TRZS-1406	TRZS-1410	240LBS	50pcs / 300ft
3/8-16	TRZS-3806	TRZS-3810	610LBS	25pcs / 150ft
1/2-13	TRZS-1206	TRZS-1210	1130LBS	12pcs / 72ft
5/8-11	TRZS-5806	TRZS-5810	1810LBS	8pcs / 48ft

## 18-8 STAINLESS STEEL

## 316 STAINLESS STEEL

THREAD	6FT	12FT	MAX LOAD
1/4-20	T2ZS-1406	T2ZS-1412	240LBS
3/8-16	T2ZS-3806	T2ZS-3812	610LBS
1/2-13	T2ZS-1206	T2ZS-1212	1130LBS
5/8-11	T2ZS-5806	T2ZS-5812	1810LBS

## BEAM CLAMPS



### ELECTRICIANS STYLE

Our heavy duty beam clamps feature single screw, two-hole assembly and are fabricated from high grade, long lasting malleable iron. Manufactured with precision to optimize functionality and dependability; jaw openings range from 3/4" to 1 1/8"; appropriate for load capacities from 125 to 600 lbs. Solid, malleable iron body will not distort or slip off beam when tightened.

PART NO	TAP SIZE	JAW	MAX LOAD
BCZM-1420	1/4-20	3/4"	125LBS
BCZM-3816	3/8-16	7/8"	300LBS
BCZM-1213	1/2-13	1-1/8"	600LBS



### JR STYLE

Designed for attaching hanger rod to the top flange of a beam or bar joist, where the flange thickness does not exceed 3/4 inch. The open U design permits rod adjustment.

PART NO	TAP SIZE	JAW	MAX LOAD
BCPM-3816	3/8-16	3/4"	400LBS
BCPM-1213	1/2-13	3/4"	500LBS
BCPM-5811	5/8-11	3/4"	600LBS



### STAMPED STEEL

These beam clamps provide an economical means of hanging medium duty loads. Their threaded backs and bottoms allow for versatility in design. Additionally, their hardened cup point screw and heavy gauge steel body will not distort when tightened on the beam.

PART NO	TAP SIZE	JAW	MAX LOAD
BCCS-1420	1/4-20	11/16"	50LBS
BCCS-3816	3/8-16	1"	100LBS



# WIRE FASTENERS

## FIXTURE HANGERS

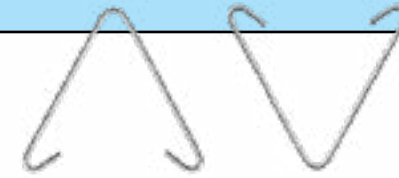

Fluorescent Light Fixture Hangers are easy to install and come in side or top mount and used with our chain and s-hooks.

PART NO	ORIENTATION	WIRE
FXHN-1000	SIDE MOUNT	.120
FXHN-2000	TOP/END MOUNT	.135



## TIE WIRE



### GALVANIZED

PART NO	GAUGE	WEIGHT/ROLL	LENGTH (APPROX)
CSTG-1635	16	3.5LBS	336ft



### PLAIN STEEL

PART NO	GAUGE	WEIGHT/ROLL	LENGTH (APPROX)
CSTP-1635	16	3.5LBS	336ft



### 316 STAINLESS STEEL

PART NO	GAUGE	WEIGHT/ROLL	LENGTH (APPROX)
C3TG-1635	16	3.5LBS	336ft

## JACK CHAIN

No.12 Single Jack Chain is ideal for suspending fixtures, lighting and other light equipment.



### GALVANIZED STEEL

PART NO	GAUGE	PAYOUT	FT/BOX	MAX LOAD
CNJB-1200-CK	12	BOX	100	29LBS
CNJB-1200-CR	12	REEL	100	29LBS
CNJB-1000-CK	10	BOX	100	43LBS

### 316 STAINLESS STEEL

PART NO	GAUGE	PAYOUT	FT/BOX	MAX LOAD
C2JB-1200-CK	12	BOX	100	29LBS



### S-HOOKS

PART NO	GAUGE	LENGTH	QTY/BOX	MAX LOAD
CNSH-1200	12	1.31"	100	31LBS
CNSH-1000	10	1.40"	100	25LBS





# STUD GUARDS



## 1-1/2" WIDE



Our stud guards are made from true 16ga steel, conforming with most electrical and plumbing building codes. Graduated sharp spikes ensure proper penetration without bounce-back seen in other brands.

PART NO	DIMENSION	HOLES	SPIKES	GAUGE	PACK
CSNP-1000	1-1/2" x 3"	2	2X2	16	100/BOX
CSNP-1000-NH	1-1/2" x 3"	NONE	2X2	16	100/BOX
CSNP-5000	1-1/2" x 5"	2	2X2	16	100/BOX
CSNP-6000	1-1/2" x 6"	2	2X2	16	100/BOX

## 3" WIDE

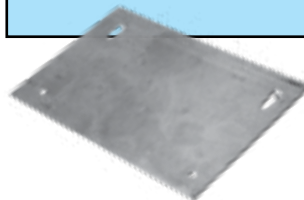

Our stud guards are made from true 16ga steel, conforming with most electrical and plumbing building codes. Graduated sharp spikes ensure proper penetration without bounce-back seen in other brands.

PART NO	DIMENSION	HOLES	SPIKES	GAUGE	PACK
CSNP-3050	3" x 5"	4	2	16	100

## BOCA PLATES



Boca Plates are primarily used to protect vertical running piping in between studs from drywall nails that could potentially puncture the piping. We offer a wide variety of lengths, widths, gauges, and hole locations to accommodate varying building codes across America.

PART NO	DIMENSION	HOLES	SPIKES	GAUGE	PACK
CSNP-3560	3-1/2" x 6"	2	NO	16	50
CSNP-3561	3-1/2" x 6"	2*	YES	16	50
CSNP-3518	3-1/2" x 18"	4	NO	16	25
CSNP-5080	5" x 8"	6	NO	16	50

\*Combination triangular hole and spike

## 1-1/2 WIDE FHA PLATES



FHA Plates are a highly utilized product in a construction project. Most building codes require the use of FHA Plates to help protect piping from nails during drywall application.

PART NO	DIMENSION	HOLES	SPIKES	GAUGE	PACK
CFHA-1609	1-1/2" x 9"	8	NO	16	100
CFHA-1612	1-1/2" x 12"	8	NO	16	100
CFHA-1618	1-1/2" x 18"	8	NO	16	100
CFHA-1624	1-1/2" x 24"	8	NO	16	100
CFHA-1209	1-1/2" x 9"	8	NO	12	100
CFHA-1212	1-1/2" x 12"	8	NO	12	100
CFHA-1218	1-1/2" x 18"	8	NO	12	100
CFHA-1224	1-1/2" x 24"	8	NO	12	100

# ENCLOSURE HARDWARE



## STEEL CONDUIT LOCKNUTS



POSI-TECH locknuts are used to secure threaded conduits or connectors to electrical junction boxes or enclosures in wet locations. The conduit locknuts allow standard junction boxes to be used with unthreaded conduit knockout openings in wet locations. Serrated teeth on the locknut bite into the box and enclosure to prevent vibratory loosening of the connection.

TRADE SIZE	STEEL	DIECAST	PACK
1/2"	LNST-0005	LNDC-0005	100
3/4"	LNST-0007	LNDC-0007	100
1"	LNST-0010	LNDC-0010	100
1-1/4"	LNST-0012	LNDC-0012	50
1-1/2"	LNST-0015	LNDC-0015	50
2"	LNST-0020	LNDC-0020	25
2-1/2"	LNST-0025	LNDC-0025	25
3"	LNST-0030	LNDC-0030	25
4"	LNST-0040	LNDC-0040	10

## SNAP-IN KNOCKOUT SEALS



POSI-TECH knockout seals are inserted into unused open box knockouts to protect exposed wires. They are used in standard, air tight or dust tight applications. POSI-TECH's snap in knockouts can seal, close and secure open knockout holes without removing box devices or covers.

TRADE SIZE	SIZE	PACK
1/2"	KOSI-0005	100
3/4"	KOSI-0007	100
1"	KOSI-0010	50
1-1/4"	KOSI-0012	50
1-1/2"	KOSI-0015	50
2"	KOSI-0020	25

## 3 PIECE KNOCKOUT SEALS



POSI-TECH knockout seals are inserted into unused open box knockouts to protect exposed wires. They are used in standard, air tight or dust tight applications. POSI-TECH's 3-piece knockout seal provides an additional layer of security for exposed boxes where additional security is required.

TRADE SIZE	SIZE	PACK
1/2"	KO3P-0005	100
3/4"	KO3P-0007	100
1"	KO3P-0010	50
1-1/4"	KO3P-0012	50
1-1/2"	KO3P-0015	50
2"	KO3P-0020	50
2-1/2"	KO3P-0025	10
3"	KO3P-0030	10
3-1/2"	KO3P-0035	10
4"	KO3P-0040	10





# STRUT ACCESSORIES

## RIGID STRUT STRAPS



**RIGID**



Designed for use with both rigid and emt conduit, this strap reduces inventory costs associated with keeping both EMT and Rigid sizes in stock.

SIZE	DESIGN LOAD	ELECTRO-GALV	304 STAINLESS	316 STAINLESS
1/2"	400LBS	SCR0050EG	SCR0050S4	SCR0050S6
3/4"	600LBS	SCR0075EG	SCR0075S4	SCR0075S6
1"	600LBS	SCR0100EG	SCR0100S4	SCR0100S6
1-1/4"	600LBS	SCR0125EG	SCR0125S4	SCR0125S6
1-1/2"	800LBS	SCR0150EG	SCR0150S4	SCR0150S6
2"	800LBS	SCR0200EG	SCR0200S4	SCR0200S6
2-1/2"	800LBS	SCR0250EG	SCR0250S4	SCR0250S6
3"	800LBS	SCR0300EG	SCR0300S4	SCR0300S6
3-1/2"	1000LBS	SCR0350EG	SCR0350S4	SCR0350S6
4"	1000LBS	SCR0400EG	SCR0400S4	SCR0400S6

## UNIVERSAL STRUT STRAPS



**EMT/RIGID**



Designed for use with both rigid and emt conduit, this strap reduces inventory costs associated with keeping both EMT and Rigid sizes in stock.

SIZE	DESIGN LOAD	ELECTRO-GALV
1/2"	400LBS	SCU0050EG
3/4"	600LBS	SCU0075EG
1"	600LBS	SCU0100EG
1-1/4"	600LBS	SCU0125EG
1-1/2"	800LBS	SCU0150EG
2"	800LBS	SCU0200EG

## CHANNEL NUTS



**Reg. Spring**

Regular spring channel nuts are designed for use with 1-5/8" x 1-5/8" channels. Case hardened with serrated channel grips, our channel nuts won't slip during installation.

SIZE	THICKNESS	ELECTRO-GALV	316 STAINLESS
1/4-20	.25"	CNR20025EG	CNR20025S6
3/8-16	.37"	CNR20037EG	CNR20037S6
1/2-13	.37"	CNR30050EG	CNR30037S6

Secure channel nuts regardless of channel depth using a top spring nut. Sets easily within the channel without the hassle of dealing with properly aligned bottom springs. For use on all 1-5/8" wide channel, regardless of depth.



**Top Spring**

SIZE	THICKNESS	ELECTRO-GALV
1/4-20	.25"	CNT20025EG
3/8-16	.37"	CNT20037EG
1/2-13	.50"	CNT30050EG

**PLEASE INQUIRE ABOUT DOMESTIC SPRING NUTS**



# FLAT STRUT FITTINGS



## SQUARE WASHERS



POSI-TECH strut square washers are used to secure threaded rod and other singular fastening requirements. Our washers provide a positive lock against channel and channel nuts, ensuring that all connections are secure and stable.

BOLT SIZE	DIMENSIONS	ELECTRO-GALV	304 STAINLESS	316 STAINLESS
1/4"	1-5/8" x 1-5/8"	F100025EG	F100025S4	F100025S6
3/8"	1-5/8" x 1-5/8"	F110037EG	F110037S4	F110037S6
1/2"	1-5/8" x 1-5/8"	F120050EG	F120050S4	F120050S6

## SPLICE PLATES



POSI-TECH splice plates are designed to join two lengths of strut channel in-line, end to end. Splice plates provide a positive lock against channel and channel nuts, ensuring that all connections are secure and stable.

DIMENSIONS	HOLES	ELECTRO-GALV	316 STAINLESS
1-5/8" x 5-3/8"	3	F310000EG	F310000S6
1-5/8" x 7-1/4"	4	F320000EG	F320000S6

## TEE SPLICE PLATES



POSI-TECH tee splice plates are designed to join two lengths of strut channel, creating a 90 degree intersection. Splice plates provide a positive lock against channel and channel nuts, ensuring that all connections are secure and stable.

DIMENSIONS	HOLES	ELECTRO-GALV
1-5/8" x 5-3/8" x 3-1/2"	4	F600000EG

## CORNER SPLICE PLATES



POSI-TECH corner splice plates are designed to join two lengths of strut channel, creating a 90 degree angle. Splice plates provide a positive lock against channel and channel nuts, ensuring that all connections are secure and stable.

DIMENSIONS	HOLES	ELECTRO-GALV
1-5/8" x 3-1/2" x 3-1/2"	3	F510000EG

**MADE IN THE USA**

Our strut fittings are proudly made in the United States of America with the highest quality standards. Available in Electro-Galv, 304 and 316 Stainless!



# ANGLE STRUT FITTINGS



## INSIDE CORNER ANGLE 45 DEGREE



POSI-TECH inside corner angles are designed to join two lengths of strut channel, creating a 45 degree acute corner joint. Angle plates provide a positive lock against channel and channel nuts, ensuring that all connections are secure and stable.

DIMENSIONS	HOLES	ELECTRO-GALV
1-5/8" x 3-1/2" x 2-1/2"	2	L610000EG
1-5/8" x 5" x 4-3/8"	4	L630000EG

## INSIDE CORNER ANGLE 90 DEGREE



POSI-TECH inside corner angles are designed to join two lengths of strut channel, creating a 90 degree corner joint. Angle plates provide a positive lock against channel and channel nuts, ensuring that all connections are secure and stable.

DIMENSIONS	HOLES	ELECTRO-GALV	316 STAINLESS
1-5/8" x 2" x 1-7/8"	2	L110000EG	L110000S6
1-5/8" x 3-7/8" x 1-7/8"	3	L120000EG	L120000S6
1-5/8" x 3-7/8" x 3-3/4"	4	L130000EG	L130000S6

## INSIDE CORNER ANGLE 135 DEGREE



POSI-TECH inside corner angles are designed to join two lengths of strut channel, creating a 135 degree (often referred to as an open 45) obtuse corner joint. Angle plates provide a positive lock against channel and channel nuts, ensuring that all connections are secure and stable.

DIMENSIONS	HOLES	ELECTRO-GALV
1-5/8" x 1-1/8" x 3-1/2"	2	L600000EG
1-5/8" x 3-11/16" x 3-1/2"	4	L620000EG

## STRUT POST BASES

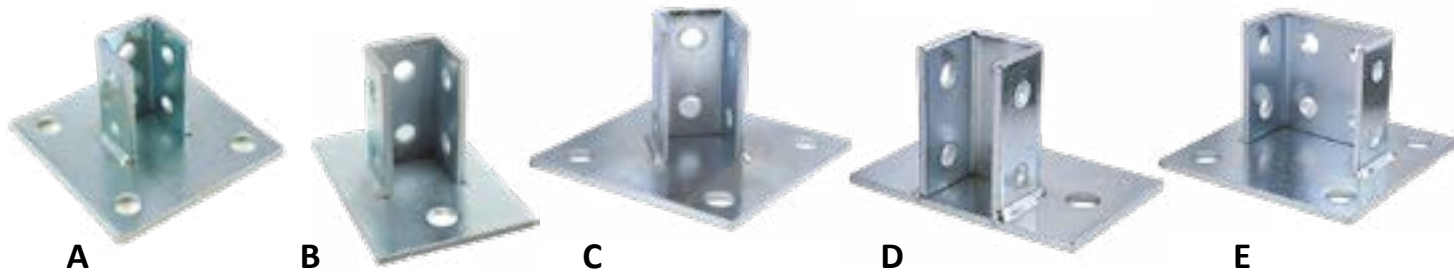

FIGURE	ORIENTATION	DIMENSIONS	ELECTRO-GALV	316 STAINLESS
A	SQUARE	6" X 6" BASE 3-1/2" TALL	P100000EG	P100000S6
B	SQUARE	4" X 6" BASE 3-1/2" TALL	P140000EG	P140000S6
C	45 DEG	6" X 6" BASE 3-1/2" TALL	P130000EG	P130000S6
D	SQUARE	4" X 6" BASE 3-1/2" TALL	P110000EG	P110000S6
E	SQUARE	6" X 6" BASE 3-1/2" TALL DBL WIDTH	P200000EG	P200000S6

# TURNT STEEL FASTENERS



## U-BOLTS



U-bolts are versatile fasteners used to secure pipes, conduit, cables, and machinery, or as an anchor in foundations and roofs. All POSI-TECH U-Bolts includes finished hex nuts and flat plate.

PIPE SIZE	WIDTH BETWEEN LEGS	THREAD	INSIDE LENGTH	ZINC PLATED STEEL	304 STAINLESS	PACK
1/2"	1"	1/4-20	2-3/4"	UBLT-1405-AK	U2LT-1405-AK	25/BOX
3/4"	1-1/8"	1/4-20	2-1/2"	UBLT-1407-AK	U2LT-1407-AK	25/BOX
1"	1-3/8"	1/4-20	2-3/4"	UBLT-1410-AK	U2LT-1410-AK	25/BOX
1-1/4"	1-3/4"	1/4-20	3"	UBLT-1412-XK	U2LT-1412-XK	10/BOX
1-1/2"	2"	1/4-20	3-1/2"	UBLT-1415-XK	U2LT-1415-XK	10/BOX
2"	2-1/2"	5/16-18	3-1/2"	UBLT-5620-XK	U2LT-5620-XK	10/BOX
2-1/2"	3"	3/8-16	4-1/8"	UBLT-3825-VK	U2LT-3825-VK	5/BOX
3"	3-1/2"	3/8-16	4-5/8"	UBLT-3830-VK	U2LT-3830-VK	5/BOX
3-1/2"	4"	3/8-16	6"	UBLT-3835-VK	U2LT-3835-VK	5/BOX
4"	4-1/2"	1/2-13	6-1/2"	UBLT-1240-VK	U2LT-1240-VK	5/BOX



## EYE BOLTS



Turned eye bolts are intended for light duty applications such as tie-downs and wire guiding. Not for use in lifting operations. All POSI-TECH eye bolts include finished hex nuts.

THREAD SIZE	OAL	THREAD LENGTH	EYE DIA	ZINC PLATED STEEL	304 STAINLESS	PACK
10-24	1-1/2"	3/4"	3/8"	NA	E2BT-3615	25/BOX
10-24	1-3/4"	7/8"	3/8"	EYBT-3617	NA	25/BOX
10-24	2"	1-5/16"	5/16"	NA	E2BT-3620	25/BOX
10-24	2-1/4"	1-3/8"	3/8"	EYBT-3622	NA	25/BOX
10-24	2-3/4"	1-7/8"	3/8"	EYBT-3627	NA	25/BOX
1/4-20	2"	7/8"	9/16"	EYBT-1420	E2BT-1420	25/BOX
1/4-20	3"	1-3/4"	9/16"	EYBT-1430	E2BT-1430	25/BOX
1/4-20	4"	2-3/4"	9/16"	EYBT-1440	E2BT-1440	10/BOX
1/4-20	5"	3"	9/16"	EYBT-1450	NA	10/BOX
5/16-18	3-1/4"	1-1/2"	3/4"	EYBT-5632	E2BT-5632	10/BOX
5/16-18	4"	2-1/4"	3/4"	EYBT-5640	E2BT-5640	10/BOX
5/16-18	5"	3"	3/4"	EYBT-5650	E2BT-5650	10/BOX
3/8-16	2-1/2"	1/2"	1"	EYBT-3825	NA	10/BOX
3/8-16	3-7/8"	2-3/8"	5/8"	NA	E2BT-3837	10/BOX
3/8-16	4"	2"	1"	EYBT-3840	E2BT-3840	10/BOX
3/8-16	5"	3"	1"	EYBT-3850	NA	5/BOX
3/8-16	6"	3"	1"	EYBT-3860	E2BT-3860	5/BOX







# ROD HANGERS



## HANGERMATE™ FOR CONCRETE SUBSTRATE



The HangerMate®+ concrete screw is a one piece, steel anchor designed for rod hanging applications such as fire protection systems, ventilation systems, electrical conduit, pipe hanging and cable trays. Tested and qualified for use in cracked concrete and seismic conditions.

PART NO	ROD SIZE	DIMENSIONS	ORIENTATION	PACK	DRIVE TOOL	MASONRY DRILL
PFM2211100	1/4-20	1/4" X 1-5/8"	VERTICAL	25/BOX	PFM1491050	DBDS-1406
PFM2211200	3/8-16	1/4" X 1-5/8"	VERTICAL	25/BOX	PFM1491100	DBDS-1406

For 1/2-13 rod, see page 136 for adapter



HangerMate® Suspenders threaded rod anchors feature a one-piece design that is both end-tapped and cross-tapped to permit both in-line mounting and side-mounting of threaded rod systems, eye rings and more.

PART NO	ROD SIZE	DIMENSIONS	ORIENTATION	PACK	DRIVE TOOL	MASONRY DRILL
PFM2271050	3/8-16	5/16" X 2-1/4"	DUAL	25	PFM2201300	DBDS-5606

## HANGERMATE™ FOR METAL SUBSTRATE



The HangerMate®+ concrete screw is a one piece, steel anchor designed for rod hanging applications such as fire protection systems, ventilation systems, electrical conduit, pipe hanging and cable trays. Tested and qualified for use in cracked concrete and seismic conditions.

PART NO	ROD SIZE	DIMENSIONS	ORIENTATION	PACK	DRIVE TOOL
PFM2231000	1/4-20	1/4-20 X 1" #3	VERTICAL	25	PFM2201200
PFM2231100	3/8-16	1/4-20 X 1" #3	VERTICAL	25	PFM2201200
PFM223110N	3/8-16	1/4-20 X 1" #3 W/NUT	VERTICAL	25	PFM2201200
PFM2231150	3/8-16	1/4-20 X 1" #5	VERTICAL	25	PFM2201200
PFM223115N	3/8-16	1/4-20 X 1" #3 W/NUT	VERTICAL	25	PFM2201200
PFM2241150	3/8-16	1/4-20 X 1" #3	HORIZONTAL	25	PFM2201200



HangerMate® Suspenders® threaded rod anchors feature a one-piece design that is both end-tapped and cross-tapped to permit both in-line mounting and side-mounting of threaded rod systems, eye rings and more.

PART NO	ROD SIZE	DIMENSIONS	ORIENTATION	PACK	DRIVE TOOL
PFM227130N	3/8-16	1/4-20 X 1-1/2" #5 W/NUT	DUAL	25	PFM2201300



# ROD HANGERS



## HANGERMATE™ FOR WOOD SUBSTRATE



The HangerMate®+ concrete screw is a one piece, steel anchor designed for rod hanging applications such as fire protection systems, ventilation systems, electrical conduit, pipe hanging and cable trays. Tested and qualified for use in cracked concrete and seismic conditions.

PART NO	ROD SIZE	DIMENSIONS	ORIENTATION	PACK	DRIVE TOOL
PFM2251000	1/4-20	1/4" X 2"	VERTICAL	25	PFM2201150
PFM2251100	3/8-16	1/4" X 2"	VERTICAL	25	PFM2201150
PFM2261000	3/8-16	1/4" X 1"	HORIZONTAL	25	PFM2201150
PFM2261050	3/8-16	1/4" X 1"	HORIZONTAL	25	PFM2201150
PFM2281100	3/8-16	1/4" X 2"	HORIZONTAL	25	PFM2201150

## ACCESSORIES AND TOOLING



Adapter for hanging 1/2" rod. Requires pairing with 3/8-16 Hangermate anchor.

PART NO	SIZE	DESCRIPTION
PFM2201050	1/2-13	ADAPTER ONLY



Socket drivers for standard CONCRETE Hangermate anchors

PART NO	FOR SIZE	DESCRIPTION
PFM1491050	1/4-20	SOCKET DRIVER FOR CONCRETE HM
PFM1491100	3/8-16	SOCKET DRIVER FOR CONCRETE HM



Socket driver for standard STEEL Hangermate anchors

PART NO	FOR SIZE	DESCRIPTION
PFM2201200	ALL	SOCKET DRIVER FOR STEEL HM



Socket driver for standard WOOD Hangermate anchors

PART NO	FOR SIZE	DESCRIPTION
PFM2201150	ALL	SOCKET DRIVER FOR WOOD HM



Socket driver for Suspenders Hangermate anchors

PART NO	FOR SIZE	DESCRIPTION
PFM2201300	3/8-16	SOCKET DRIVER FOR SUSPENDER HM





# CONCRETE ANCHORS



## PIPE SPIKES™

The Pipe Spike is a, one-piece, vibration resistant anchor for use in concrete block or stone. Designed to suspend threaded rod and fasteners, the Pipe Spike anchor is formed with an "s" shaped configuration at the working end of the anchor to create an expansion mechanism. Since the anchor is pre-formed, there is no secondary tightening operation required which greatly reduces the overall cost of an anchor installation.



ROD SIZE	LENGTH	PART NO	DRILL DIA	SUGGESTED DRILL BIT
1/4"	1-1/4"	ANPS-1400	1/4"	DBDS-1406
3/8"	1-1/2"	ANPS-3800	1/4"	DBDS-1406

Tie Wire Pipe Spike featuring a eyelet designed for securing suspended ceiling wire and other fixtures.



HOLE SIZE	LENGTH	PART NO	DRILL DIA	SUGGESTED DRILL BIT
3/16"	1-1/8"	ANPS-3600-TW	3/16"	DBDS-3606
9/32"	1-1/8"	ANPS-1400-TW	1/4"	DBDS-1406

## DROP-IN ANCHORS



The Steel Dropin is an all-steel, machine bolt anchor available in carbon steel and two types of stainless steel. It can be used in solid concrete, hard stone, and solid block. A coil-thread version for forming applications is also available.

ROD/ANCHOR SIZE	LENGTH	ZINC STEEL	304 STAINLESS	316 STAINLESS	DRILL DIA	SDS DRILL BIT	SETTING TOOL
1/4-20	1"	ANDI-1438-CK	A2DI-1438-CK	A3DI-1438-CK	3/8"	DBDS-3806	TLDI-1400
3/8-16	1-9/16"	ANDI-3812-BK	A2DI-3812-BK	A3DI-3812-BK	1/2"	DBDS-1206	TLDI-3800
1/2-13	2"	ANDI-1258-BK	A2DI-1258-BK	A3DI-1258-BK	5/8"	DBDS-5806	TLDI-1200
5/8-11	2-1/2"	ANDI-5834-AK	A2DI-5834-AK	A3DI-5834-AK	3/4"	DBDS-3406	TLDI-5800
3/4-10	3-3/16"	ANDI-3410-XK	A2DI-3410-XK	A3DI-3410-XK	1"	DBDS-10060	TLDI-3400

Applications where user does not have an SDS drill available, please refer to page 117 for smooth shank masonry drill bits.



TLDI / TLSI DROP-IN SETTING TOOL

## MINI DROP-IN

The Mini Dropin is a carbon steel, machine bolt anchor for use in shallow embedment applications. Besides, solid concrete and hollow core concrete plank, it can be used in hard stone and solid block. It may also be used in overhead applications.



Stop bits ensure proper drilling depth for drop-in anchors. This is especially important when drilling into post tension slabs. The 1.25" shoulder keeps user from over drilling. Fits all SDS+ Hammers



DBDA STOP BIT

ROD/ANCHOR SIZE	LENGTH	ZINC STEEL	SDS STOP BIT	SETTING TOOL
1/4-20	5/8"	ANDI-1438-S-CK	DBDA-3878	TSDI-1400
3/8-16	3/4"	ANDI-3812-S-BK	DBDA-1256	TSDI-3800
1/2-13	1"	ANDI-1258-S-BK	DBDA-5813	TSDI-1200



# CONCRETE ANCHORS



## CALK-IN™ ANCHORS



TLMS

The Calk-In™ is a pre-assembled precision cast calking type machine bolt anchor which can be used in concrete, block, brick or stone. The anchor consists of an antimonial lead alloy calking sleeve and a Zamac alloy internally-threaded expander cone.

ROD/ANCHOR SIZE	LENGTH	PART NO	DRILL DIA	SUGGESTED DRILL BIT	HAMMER SET TOOL
10-24	.84"	ANMS-1024	3/8"	DBDS-3806	TLMS-1024
1/4-20	.93"	ANMS-1420	1/2"	DBDS-1206	TLMS-1400
5/16-18	1.00"	ANMS-5618	5/8"	DBDS-5806	TLMS-5600
3/8-16	1.30"	ANMS-3816	3/4"	DBDS-3406	TLMS-3800
1/2-13	1.50"	ANMS-1213	7/8"	DBDS-7806	TLMS-1200

## RAPIDSET® CALK-IN ANCHOR TOOL

- The fastest, easiest and most reliable way to install machine screw anchors (Calk-In™ Anchors)
- Power tool does all the work—no pounding with setting tools
- Put RapidSet® Installation Tool into power tool, trigger tool to rapidly spin anchor onto tool, insert into hole and trigger tool
- Eliminates the need for anchor to be bottom bearing, great for use in hollow block
- Automatically sets anchor just below the surface—no guessing on depth



SIZE	PART NO
10-24	EZB-790
1/4-20	EZB-800
3/8-16	EZB-820



## LAG SHIELDS™

The Lag Shield™ is a screw style anchor designed for use with lag bolts. It is suitable for use in concrete and the mortar joints of block or brick walls. Lag Shield™ anchors are formed from Zamac alloy. In harder masonry materials, short style Lag Shields are used to reduce drilling time. The long style version is used in soft or weak masonry for improved strength.

### SHORT



SIZE	LENGTH	PART NO	DRILL DIA	SUGGESTED DRILL BIT
1/4"	1"	ANLS-1412	1/2"	DBDS-1206
3/8"	1-3/4"	ANLS-3858	5/8"	DBDS-5806
1/2"	2"	ANLS-1234	3/4"	DBDS-3406

### LONG



SIZE	LENGTH	PART NO	DRILL DIA	SUGGESTED DRILL BIT
1/4"	1-1/2"	ANLL-1412	1/2"	DBDS-1206
3/8"	2-1/2"	ANLL-3858	5/8"	DBDS-5806
1/2"	3"	ANLL-1234	3/4"	DBDS-3406





# CONCRETE ANCHORS



## WEDGE ANCHORS



The Power-Stud+ SD1 anchor is a fully threaded, torque-controlled, wedge expansion anchor which is designed for consistent performance in cracked and uncracked concrete. Suitable base materials include normal-weight concrete, structural sand-lightweight concrete and concrete over metal deck. The anchor is manufactured with a zinc plated carbon steel body and expansion clip. Nut and washer are included.

DIAMETER	LENGTH	ZINC STEEL	304 STAINLESS	316 STAINLESS	DRILL DIA	SDS DRILL BIT
1/4"	1-3/4"	ANWG-1417	A2WG-1417	A3WG-1417	1/4"	DBDS-1406
1/4"	2-1/4"	ANWG-1422	A2WG-1422	A3WG-1422	1/4"	DBDS-1406
1/4"	3-1/4"	ANWG-1432	A2WG-1432	A3WG-1432	1/4"	DBDS-1406
3/8"	2-1/4"	ANWG-3822	A2WG-3822	A3WG-3822	3/8"	DBDS-3806
3/8"	2-3/4"	ANWG-3827	A2WG-3827	A3WG-3827	3/8"	DBDS-3806
3/8"	3"	ANWG-3830	A2WG-3830	A3WG-3830	3/8"	DBDS-3806
3/8"	3-1/2"	ANWG-3835	A2WG-3835	A3WG-3835	3/8"	DBDS-3806
3/8"	3-3/4"	ANWG-3837	A2WG-3837	A3WG-3837	3/8"	DBDS-3806
3/8"	5"	ANWG-3850	A2WG-3850	A3WG-3850	3/8"	DBDS-3812
3/8"	7"	ANWG-3870	A2WG-3870	A3WG-3870	3/8"	DBDS-3812
1/2"	2-3/4"	ANWG-1227	A2WG-1227	A3WG-1227	1/2"	DBDS-1206
1/2"	3-3/4"	ANWG-1237	A2WG-1237	A3WG-1237	1/2"	DBDS-1206
1/2"	4-1/2"	ANWG-1242	A2WG-1242	A3WG-1242	1/2"	DBDS-1206
1/2"	5-1/2"	ANWG-1255	A2WG-1255	A3WG-1255	1/2"	DBDS-1212
1/2"	7"	ANWG-1270	A2WG-1270	A3WG-1270	1/2"	DBDS-1212

Larger sizes available. Please inquire with customer service.

## EXPANSION ANCHORS

Expansion machine bolt anchors are particularly suited for materials of questionable strength. It can be used in solid concrete and some block, brick and stone base materials.



### SINGLE

SIZE	LENGTH	PART NO	DRILL DIA	SUGGESTED DRILL BIT
1/4"	1"	ANLS-1412	1/2"	DBDS-1206
3/8"	1-3/4"	ANLS-3858	5/8"	DBDS-5806
1/2"	2"	ANLS-1234	3/4"	DBDS-3406

### DOUBLE

SIZE	LENGTH	PART NO	DRILL DIA	SUGGESTED DRILL BIT
1/4"	1-1/2"	ANLL-1412	1/2"	DBDS-1206
3/8"	2-1/2"	ANLL-3858	5/8"	DBDS-5806
1/2"	3"	ANLL-1234	3/4"	DBDS-3406



# CONCRETE ANCHORS

## SLEEVE ANCHORS



The Power-Bolt™ anchor is a heavy duty sleeve style anchor which is vibration resistant and removable. It is available with a finished hex or acorn head and can be used in concrete, block, brick, or stone

DIAMETER	LENGTH	ZINC STEEL	304 STAINLESS	DRILL DIA	SDS DRILL BIT
1/4"*	1-3/8"	ANSV-1413	A2SV-1413	1/4"	DBDS-1406
1/4"*	2-1/4"	ANSV-1422	A2SV-1422	1/4"	DBDS-1406
3/8"	1-7/8"	ANSV-3818	A2SV-3818	3/8"	DBDS-3806
3/8"	3"	ANSV-3830	A2SV-3830	3/8"	DBDS-3806
3/8"	4"	ANSV-3840	A2SV-3840	3/8"	DBDS-3806
1/2"	2-1/2"	ANSV-1225	A2SV-1225	1/2"	DBDS-1206
1/2"	3"	ANSV-1230	A2SV-1230	1/2"	DBDS-1206
1/2"	3-3/4"	ANSV-1237	A2SV-1237	1/2"	DBDS-1206
1/2"	5-1/4"	ANSV-1252	A2SV-1252	1/2"	DBDS-1212
1/2"	6"	ANSV-1260	A2SV-1260	1/2"	DBDS-1212

\*1/4" Sleeve Anchors feature an acorn head

## PRE-CAST CONCRETE INSERTS FOR METAL SUBSTRATES



Bang-It concrete inserts are specifically designed to provide hanger attachments for mechanical, electrical, plumbing (MEP) and fire protection. Bang-It concrete inserts are designed for installation in and through composite steel deck (i.e. "pan-deck") used to support newly poured concrete floors or roof slabs. After installation, the protective sleeve of the insert protrudes below the surface of the deck. The sleeves are color coded by size and allow overhead attachment of steel threaded rod in sizes ranging from 1/4" to 3/4" in diameter. The sleeve prevents sprayed fireproofing material and acoustical dampening products from clogging the internal threads of the insert. It also prevents burying, masking or losing the insert location. A hex impact plate offers resistance to rotation within the concrete as a steel threaded rod is being installed.

ROD DIAMETER	COLOR	PART NO
1/4"	BROWN	BBMS-2500
3/8"	GREEN	BBMS-3700
1/2"	YELLOW	BBMS-5000

## PRE-CAST CONCRETE INSERTS FOR WOOD SUBSTRATES



Wood-Knocker concrete inserts are specifically designed to provide hanger attachments for mechanical, electrical, plumbing (MEP) and fire protection. Wood-Knocker II concrete inserts are installed onto wooden forms used to support newly poured concrete floor slabs, roof slabs or walls. When the forms are stripped, the color-coded flange is visibly embedded in the concrete surface. The inserts allow the attachment of steel threaded rod or threaded bolts in sizes ranging from 1/4" to 3/4" in diameter. The hex impact plate offers resistance to rotation within the concrete as a steel threaded rod or threaded bolt is being installed.

ROD DIAMETER	COLOR	PART NO
1/4"	BROWN	BBWF-2500
3/8"	GREEN	BBWF-3700
1/2"	YELLOW	BBWF-5000



# THREADED ANCHORS

## CONCRETE SCREWS - HEX WASHER HEAD (W/ SLOT)



410 SS



AVAILABLE IN CONTRACTOR BUCKETS

Posi-tech Concrete Screw Anchors are designed to meet the needs of most light to medium duty applications in concrete, block and brick. Our Concrete Screw Anchor is produced in either hex washer head or Phillips flat head styles in both blue rust preventative coated and 410 stainless steel.

DIA	LENGTH	BLUE STEEL	410 STAINLESS	DRILL DIA	DRILL BIT
3/16"	1-1/4"	ANTH-3612	A2TH-3612	5/32"	DBTH-0532
3/16"	1-3/4"	ANTH-3617	A2TH-3617	5/32"	DBTH-0532
3/16"	2-1/4"	ANTH-3622	A2TH-3622	5/32"	DBTH-1532
3/16"	2-3/4"	ANTH-3627	A2TH-3627	5/32"	DBTH-1532
3/16"	3-1/4"	ANTH-3632	A2TH-3632	5/32"	DBTH-2532
3/16"	4"	ANTH-3640	A2TH-3640	5/32"	DBTH-2532
1/4"	1-1/4"	ANTH-1412	A2TH-1412	3/16"	DBTH-0316
1/4"	1-3/4"	ANTH-1417	A2TH-1417	3/16"	DBTH-0316
1/4"	2-1/4"	ANTH-1422	A2TH-1422	3/16"	DBTH-1316
1/4"	2-3/4"	ANTH-1427	A2TH-1427	3/16"	DBTH-1316
1/4"	3-1/4"	ANTH-1432	A2TH-1432	3/16"	DBTH-2316
1/4"	4"	ANTH-1440	A2TH-1440	3/16"	DBTH-2316
1/4"	5"	ANTH-1450	A2TH-1450	3/16"	DBTH-3316

See page 117 for Concrete Screw Drill Bits (Both tanged smooth shank and SDS available)

## CONCRETE SCREWS - FLAT HEAD - PHILLIPS DRIVE



410 SS



AVAILABLE IN CONTRACTOR BUCKETS

DIA	LENGTH	BLUE STEEL	410 STAINLESS	DRILL DIA	DRILL BIT
3/16"	1-1/4"	ANTF-3612	A2TF-3612	5/32"	DBTH-0532
3/16"	1-3/4"	ANTF-3617	A2TF-3617	5/32"	DBTH-0532
3/16"	2-1/4"	ANTF-3622	A2TF-3622	5/32"	DBTH-1532
3/16"	2-3/4"	ANTF-3627	A2TF-3627	5/32"	DBTH-1532
3/16"	3-1/4"	ANTF-3632	A2TF-3632	5/32"	DBTH-2532
3/16"	4"	ANTF-3640	A2TF-3640	5/32"	DBTH-2532
1/4"	1-1/4"	ANTF-1412	A2TF-1412	3/16"	DBTH-0316
1/4"	1-3/4"	ANTF-1417	A2TF-1417	3/16"	DBTH-0316
1/4"	2-1/4"	ANTF-1422	A2TF-1422	3/16"	DBTH-1316
1/4"	2-3/4"	ANTF-1427	A2TF-1427	3/16"	DBTH-1316
1/4"	3-1/4"	ANTF-1432	A2TF-1432	3/16"	DBTH-2316
1/4"	4"	ANTF-1440	A2TF-1440	3/16"	DBTH-2316
1/4"	5"	ANTF-1450	A2TF-1450	3/16"	DBTH-3316

See page 117 for Concrete Screw Drill Bits (Both tanged smooth shank and SDS available)

## CONCRETE SCREW TOOL KIT

PART NO	DESCRIPTION
TLTH-1000	7 PC INSTALL KIT (BLOW MOLDED CASE)



# THREADED ANCHORS



## WEDGE BOLT™



The Wedge-Bolt+ anchor is a one piece, heavy duty screw anchor with a finished hex head. It is simple to install, easy to identify and fully removable. The Wedge-Bolt+ has many features and benefits that make it well suited for many applications in a variety of base materials. The anchor is designed for consistent and reliable performance in cracked and uncracked concrete.

DIA	LENGTH	ZINC PLATED	DRILL DIA	DRILL BIT
3/8"	1-3/4"	ANCA-3817	3/8"	DBDS-3806
3/8"	2-1/2"	ANCA-3825	3/8"	DBDS-3806
3/8"	3"	ANCA-3830	3/8"	DBDS-3806
3/8"	4"	ANCA-3840	3/8"	DBDS-3806
3/8"	5"	ANCA-3850	3/8"	DBDS-3812
3/8"	6"	ANCA-3860	3/8"	DBDS-3812
1/2"	3"	ANCA-1230	1/2"	DBDS-1206
1/2"	4"	ANCA-1240	1/2"	DBDS-1206
1/2"	5"	ANCA-1250	1/2"	DBDS-1212
1/2"	6"	ANCA-1260	1/2"	DBDS-1212

See page 117 for Concrete Screw Drill Bits (Both tanged smooth shank and SDS available)

## ACOUSTICAL SCREWS



Easily secure tie wire, ceiling grid wire and light duty jack chain from these easy to install acoustical screws. Available in lag point for wood substrates and self-drilling for light gauge steel.

### SELF-DRILLING FOR STEEL

PART NO	SIZE	HOLE DIAMETER	THREAD LENGTH	FLANGE WIDTH
ASDS-1420	1/4" x 2"	3/16"	3/4"	9/16"
ASDS-1430	1/4" x 3"	3/16"	2"	9/16"

### LAG POINT FOR WOOD

ASDS-1430	1/4" x 3"	3/16"	1-5/8"	9/16"
-----------	-----------	-------	--------	-------

### DRIVER TOOL

TLAL-1000	ALL ACOUSTICAL SCREWS
-----------	-----------------------

## LEAD WOOD SCREW ANCHORS



DIA	LENGTH	PART NO	DRILL DIA	DRILL BIT
6-8	1"	ANWS-0610	1/4"	DBDS-1406
10-14	1"	ANWS-1010	5/16"	DBDS-5606
10-14	1-1/2"	ANWS-1015	5/16"	DBDS-5606





# POWDER ACTUATED

## POWDER LOADS



POWER LEVEL	COLOR CODE	22 CALIBER SINGLE SHOTS Powers: P1000, P2201, P7201 Ramset®: 721, M70, RS22 Hilti®: DXE37, DXE72	25 CALIBER STRIP LOADS Powers: P35s Hilti®: DX35	27 CALIBER STRIP LOADS Powers: P3500, PA3500, PA351, P3600, Sniper Ramset®: SA270, Viper, Cobra Hilti®: DX350, DX351, DX36M and DX451, DX460, DX2
1	GRAY	ANDL-0001		
2	BROWN	ANDL-0002		ANDL-0002-27
3	GREEN	ANDL-0003	ANDL-0003-25	ANDL-0003-27
4	YELLOW	ANDL-0004	ANDL-0004-25	ANDL-0004-27
5	RED		ANDL-0005-25	ANDL-0005-27

## PINS

Drive pins with a 0.300" diameter head are designed for permanently fastening a fixture to concrete, some types of masonry and A36 or A572 structural steel. Drive pins are manufactured with a 0.145" diameter shank in various lengths. A plastic flute is mounted over the point to retain the drive pin in the fastener guide of the tool providing guidance during the driving operation.



## .300 DRIVE PINS

PART NO	LENGTH	DIA
ANDP-0005	1/2"	.145
ANDP-0007	3/4"	.145
ANDP-0010	1"	.145
ANDP-0012	1-1/4"	.145
ANDP-0015	1-1/2"	.145
ANDP-0020	2"	.145
ANDP-0025	2-1/2"	.145
ANDP-0030	3"	.145



## .300 DRIVE PINS w/ 7/8 WASHER

PART NO	LENGTH	DIA
ANDW-0010	1"	.145
ANDW-0012	1-1/4"	.145
ANDW-0015	1-1/2"	.145
ANDW-0020	2"	.145
ANDW-0025	2-1/2"	.145
ANDW-0030	3"	.145

## CEILING CLIP ASSEMBLIES

For acoustical applications and suspended ceiling systems or light fixtures. Designed for attaching ceiling clips and threaded rod to Concrete or Steel



PART NO	LENGTH	DIA
ANCC-0010	1"	.145



# POWDER ACTUATED



## THREADED STUDS



Threaded studs are available in 1/4"-20 and 3/8"-16 thread diameters with a variety of thread and shank lengths for use in concrete, some types of concrete block, and A36 or A572 structural steel. They are used for applications where it may be desirable to remove the fixture, where shimming may be required or for suspending sprinkler systems.

PART NO	THREAD	THREAD LENGTH	SHANK LENGTH	PIN DIA
ANDS-0705	1/4-20	3/4"	1/2"	.145
ANDS-0707	1/4-20	3/4"	3/4"	.145
ANDS-0510	1/4-20	1/2"	1"	.145
ANDS-0710	1/4-20	3/4"	1"	.145
ANDS-0712	1/4-20	3/4"	1-1/4"	.145

PART NO	THREAD	THREAD LENGTH	SHANK LENGTH	PIN DIA
ANDS-3807	3/8-16	1-1/4"	3/4"	.205
ANDS-3810	3/8-16	1-1/4"	1"	.205
ANDS-3812	3/8-16	1-1/4"	1-1/4"	.205

## BX AND CONDUIT CLIPS

For the electrical trade, BX and conduit clips are provided in various sizes for attaching conduit to base materials where easy removal is not a requirement.



PART NO	CONDUIT SIZE	SHANK LENGTH	PIN DIA
ANDC-38BX	BX	1"	.145
ANDC-0510	1/2" EMT	1"	.145
ANDC-0710	3/4" EMT	1"	.145
ANDC-1010	1" EMT	1"	.145

## POWDERLESS PINS

Hammer Drive pins are designed for permanently fastening a fixture to concrete and some types of masonry. This fastener is designed for use in a standard hand tool and should not be used in a powder actuated tool. The pins are formed with a 1/4" diameter head on one end and a 0.140" diameter shank in various lengths. A 3/8" diameter steel washer is mounted over the point to retain the drive pin in the fastener guide of the tool providing guidance during the driving operation. The fastener is recommended for light duty static load applications where holding power is not a critical factor. It should not be used overhead.



PART NO	LENGTH
ANDH-1407	3/4"
ANDH-1410	1"
ANDH-1412	1-1/4"
ANDH-1415	1-1/2"
ANDH-1420	2"



## DRIVER TOOL

2lb Hammer Recommended for best results.

PART NO
TLDH-1400



# WALL ANCHORS

## TOGGLE BOLTS

The Toggle Bolt is a spring wing type hollow wall anchor designed for use in block, wallboard and other hollow base materials. The Toggle Bolt is a two-part assembly consisting of a slot/phillips truss head machine screw and a matching spring wing toggle.



AVAILABLE IN



CONTRACTOR BUCKETS

DIA	LENGTH	ZINC PLATED	HOLE DIA
1/8" (6-32)	2"	ANTC-1802	3/8"
1/8" (6-32)	3"	ANTC-1803	3/8"
1/8" (6-32)	4"	ANTC-1804	3/8"
3/16" (10-24)	2"	ANTC-3602	1/2"
3/16" (10-24)	3"	ANTC-3603	1/2"
3/16" (10-24)	4"	ANTC-3604	1/2"
3/16" (10-24)	5"	ANTC-3605	1/2"
3/16" (10-24)	6"	ANTC-3606	1/2"
1/4-20	3"	ANTC-1403	5/8"
1/4-20	4"	ANTC-1404	5/8"
1/4-20	5"	ANTC-1405	5/8"
1/4-20	6"	ANTC-1406	5/8"
5/16-18	3"	ANTC-5603	7/8"
5/16-18	4"	ANTC-5604	7/8"
5/16-18	5"	ANTC-5605	7/8"
5/16-18	6"	ANTC-5606	7/8"
3/8-16	3"	ANTC-3803	7/8"
3/8-16	4"	ANTC-3804	7/8"
3/8-16	5"	ANTC-3805	7/8"
3/8-16	6"	ANTC-3806	7/8"
1/2-13	4"	ANTC-1204	1-1/4"
1/2-13	6"	ANTC-1206	1-1/4"

## TOGGLE WINGS (WITHOUT SCREWS)

PART NO	DIA	HOLE DIA
ANTW-1800	1/8" (6-32)	3/8"
ANTW-3600	3/16" (10-24)	1/2"
ANTW-1400	1/4-20	5/8"
ANTW-5600	5/16-18	7/8"
ANTW-3800	3/8-16	7/8"
ANTW-1200	1/2-13	1-1/4"



## TRUSS HEAD SLOT/PHIL MACHINE SCREWS

DIA	2"	3"	4"	5"	6"
1/8" (6-32)	MSTC-1820	MSTC-1830	MSTC-1840		
3/16" (10-24)	MSTC-3620	MSTC-3630	MSTC-3640	MSTC-3650	MSTC-3660
1/4-20	MSTC-1420	MSTC-1430	MSTC-1440	MSTC-1450	MSTC-1460
5/16-18		MSTC-5630	MSTC-5640	MSTC-5650	MSTC-5660
3/8-16		MSTC-3830	MSTC-3840	MSTC-3850	MSTC-3860
1/2-13		MSTC-1230	MSTC-1240	MSTC-1250	MSTC-1260



# WALL ANCHORS

## SNAPTOGGLES™

The SNAPTOGGLE anchor is a heavy-duty hollow wall anchor for use in walls, ceilings, or floors of materials such as gypsum board or drywall. The anchor is pre-assembled and ready for immediate use. The ratcheting strap and locking cap assembly positions the one-piece zinc-plated (or stainless) steel anchoring channel flush against the rear of the wall. The cap slides down the straps to lock flush against the front of the wall. The straps on the outside of the wall are then easily and quickly snapped off by hand flush with the surface of the wall (no extra tools required).



Now available with 2-1/2" screws included on 3/16" and 1/4"

ANCHOR SIZE	ZINC STEEL	304 STAINLESS	SCREW INCLUDED	USE WITH SCREW	HOLE DIA
3/16"	ANTS-3600	A2TS-3600	NO	10-24	1/2"
3/16"	ANTS-3625	NA	YES	10-24	1/2"
1/4"	ANTS-1400	A2TS-1400	NO	1/4-20	1/2"
1/4"	ANTS-1425	NA	YES	1/4-20	1/2"
5/16"	ANTS-5600	A2TS-5600	NO	5/16-18	3/4"
3/8"	ANTS-3800	A2TS-3800	NO	3/8-16	3/4"
1/2"	ANTS-1200	A2TS-1200	NO	1/2-13	3/4"

Screws are available on page 157

## HOLLOW WALL POLLY ANCHORS

The Polly™ is a sleeve type hollow wall anchor designed for use in base materials such as plaster, wallboard, concrete block, hollow tile or plywood. Self-piercing, requires no pre-drilling.



PART NO	LENGTH	WALL THICKNESS
ANHW-1318	1-3/8"	1/8" - 1/4"
ANHW-2038	2"	3/8" - 1/2"
ANHW-2312	2-3/8"	1/2" - 3/4"

Hollow Wall Tool

ANHW-2312	2-3/8"	1/2" - 3/4"
-----------	--------	-------------

## PLASTIC TOGGLES



Plastic Toggle anchors ideal for static applications requiring light to medium load performance. Installation is very fast, needing a pre-drilled 5/16" diameter hole. The fastener pre-installs without a screw, allowing for easy placement and removal of the fixture. Pop-Toggle™ fasteners are not recommended for use overhead or applications where holding values are critical.

PART NO	WALL THICKNESS	SCREW SIZE	HOLE SIZE	FOR SCREW SIZES	SUGGESTED TWIST DRILL
ANPT-3800	1/8" - 1/4"	#6-#14	5/16"	#6 - #14	DBHS-0516
ANPT-1200	3/8" - 1/2"	#6-#14	5/16"	#6 - #14	DBHS-0516
ANPT-5800	5/8" - 3/4"	#6-#14	5/16"	#6 - #14	DBHS-0516





# WALL ANCHORS

## WALL DOG DRYWALL ANCHORS



- Screw and anchor in one; Easily penetrate wood and metal studs
- Holds up to 50-Pound (1/2-Inch drywall), 175-Pound (4000 psi concrete), 95-Pound (brick)
- For use in wallboard, plywood, concrete, block, brick and plaster
- 1-1/4" length (ANWD-1409 and ANWD-1410 are 1-1/2")

PART NO	HEAD STYLE	DRIVE	HEAD COLOR	PLATING
ANWD-1400	OVAL	PHILLIPS	CHROME	CHROME
ANWD-1401	PAN	PHILLIPS	CHROME	CHROME
ANWD-1402	OVAL	PHILLIPS	WHITE	CHROME
ANWD-1403	PAN	PHILLIPS	WHITE	CHROME
ANWD-1405	PAN	SQUARE	CHROME	CHROME
ANWD-1406	HEX	SLOT/PHIL	CHROME	CHROME
ANWD-1407	OVAL	PHILLIPS	BRASS	BRASS
ANWD-1408	PAN	PHILLIPS	BRASS	BRASS
ANWD-1409	PAN	PHILLIPS	BRONZE	BRONZE
ANWD-1410	PAN	PHILLIPS	BLACK	BLACK

## EASY DRYWALL ANCHORS



- No pre-drilling necessary - drills directly into drywall even if you hit a wood stud.
- Starts easier than other self-drilling drywall anchors
- A superior alternative to traditional plastic plugs and mollys.
- Each kit includes 50 anchors and 50 pan head slot/phillips combo sheet metal screws

PART NO	TYPE	FOR SCREW DIA
ANEZ-0208	ZAMAK STANDARD	#8
ANEZ-0206	ZAMAK MINI	#6
ANEP-0208	NYLON STANDARD	#8
ANEP-0206	NYLON MINI	#6



## EASY DRYWALL ANCHOR KITS



PART NO	TYPE	SCREW DIA	SCREW LENGTH
ANKE-0050	ZAMAK STANDARD	#8	1"
ANKE-0051	ZAMAK STANDARD	#8	1-1/4"
ANKE-0060	ZAMAK MINI	#6	1"

PART NO	TYPE	SCREW DIA	SCREW LENGTH
ANKP-0050	NYLON STANDARD	#8	1"
ANKP-0051	NYLON STANDARD	#8	1-1/4"
ANKP-0060	NYLON MINI	#6	1"



# WALL ANCHORS

## HAMMER SCREW™ ANCHORS



The Zamac Hammer-Screw® is a unique, one-step drive anchor featuring a Phillips type head and a screw thread for use in concrete, block, brick or stone. With a body formed from corrosion resistant Zamac alloy and a carbon or stainless steel drive screw, this anchor has been developed by Powers as an improvement over standard nail-in anchors.

PART NO	DIA	DEPTH	DRILL DIA	SDS DRILL BIT
ANZH-1407	1/4"	3/4"	1/4"	DBDS-1406
ANZH-1410	1/4"	1"	1/4"	DBDS-1406
ANZH-1412	1/4"	1-1/4"	1/4"	DBDS-1406
ANZH-1415	1/4"	1-1/2"	1/4"	DBDS-1406
ANZH-1420	1/4"	2"	1/4"	DBDS-1406
ANZH-1422	1/4"	2-1/4"	1/4"	DBDS-1406
ANZH-1430	1/4"	3"	1/4"	DBDS-1406

## HAMMER DRIVE ANCHORS



The Zamac Nailin® is a tamper-proof nail drive anchor which has a body formed from Zamac alloy. Nails are available in carbon or stainless steel. The anchor can be used in concrete, block, brick or stone. This anchor is not recommended for applications overhead.

PART NO	DIA	DEPTH	DRILL DIA	SDS DRILL BIT
ANZN-3608	3/16"	7/8"	3/16"	DBDS-3606
ANZN-1407	1/4"	3/4"	1/4"	DBDS-1406
ANZN-1410	1/4"	1"	1/4"	DBDS-1406
ANZN-1412	1/4"	1-1/4"	1/4"	DBDS-1406
ANZN-1415	1/4"	1-1/2"	1/4"	DBDS-1406
ANZN-1420	1/4"	2"	1/4"	DBDS-1406
ANZN-1430	1/4"	3"	1/4"	DBDS-1406



## NYLON NAIL ANCHORS



The Nylon Nailin® is a pin drive anchor with a body formed from engineered nylon and nails available in carbon and stainless steel. The anchor can be used in concrete, block, or brick. This anchor is not recommended for applications overhead.

PART NO	DIA	DEPTH	DRILL DIA	SDS DRILL BIT
ANNN-3610	3/16"	1"	3/16"	DBDS-3606
ANNN-3615	3/16"	1-1/2"	3/16"	DBDS-3606
ANNN-1410	1/4"	1"	1/4"	DBDS-1406
ANNN-1415	1/4"	1-1/2"	1/4"	DBDS-1406
ANNN-1420	1/4"	2"	1/4"	DBDS-1406





# WALL ANCHORS



- Anchor features a tapered end for easy installation
- Flanged ribs prevent turning or twisting in the hole
- Carbide drill bit included with each kit



UNLESS STATED OTHERWISE, EACH KIT CONTAINS 100 SCREWS AND ANCHORS PLUS DRILL BIT

## 3/16 CONICAL ANCHOR KIT

PART NO	ANCHOR SIZE	ANCHOR COLOR	SCREW SIZE	SCREW HD DRIVE	HOLE SIZE
ANKR-3601	6-8	RED	#8 X 1"	PAN PHILLIPS	3/16"
ANKR-3606	6-8	RED	#8 X 1"	HEX SLOT COMBO	3/16"

## 1/4 CONICAL ANCHOR KIT

PART NO	ANCHOR SIZE	ANCHOR COLOR	SCREW SIZE	SCREW HD DRIVE	HOLE SIZE
ANKR-1401	10-12	RED	#10 X 1"	PAN PHILLIPS	1/4"
ANKB-1401	10-12	BLUE	#10 X 1"	PAN PHILLIPS	1/4"
ANKW-1401	10-12	WHITE	#10 X 1"	PAN PHILLIPS	1/4"
ANKG-1401	10-12	GREEN	#10 X 1"	PAN PHILLIPS	1/4"

ANKR-1406	10-12	RED	#10 X 1"	HEX SLOT COMBO	1/4"
ANKB-1406	10-12	BLUE	#10 X 1"	HEX SLOT COMBO	1/4"
ANKW-1406	10-12	WHITE	#10 X 1"	HEX SLOT COMBO	1/4"
ANKG-1406	10-12	GREEN	#10 X 1"	HEX SLOT COMBO	1/4"

ANKR-1405	10-12	RED	#10 X 1"	SQUARE RECESS	1/4"
ANKB-1405	10-12	BLUE	#10 X 1"	SQUARE RECESS	1/4"

## 5/16 CONICAL ANCHOR KIT

PART NO	ANCHOR SIZE	ANCHOR COLOR	SCREW SIZE	SCREW HD DRIVE	HOLE SIZE
ANKR-5601	14-16	RED	#14 X 1"	PAN PHILLIPS	5/16"
ANKR-5606	14-16	RED	#14 X 1"	HEX SLOT COMBO	5/16"

5/16" ANCHOR KITS CONTAIN 50PCS OF EACH SCREW AND ANCHOR

## 1/4 SUPER RIBBED ANCHOR KIT

Anchors feature expanding plastic shield that expands as the screw is tightened with engineered ribs holding anchor firmly in place. Can be used in all types of base materials including concrete and gypsum drywall.



PART NO	ANCHOR SIZE	ANCHOR COLOR	SCREW SIZE	SCREW HD DRIVE	HOLE SIZE
ANKY-1401	10-12	YELLOW	#10 X 1"	PAN PHILLIPS	1/4"
ANKY-1406	10-12	YELLOW	#10 X 1"	HEX SLOT COMBO	1/4"



# WALL ANCHORS

## CONICAL ANCHORS

Conical wall anchors are a plastic anchor designed for use with lightweight fixtures using a sheet metal or wood screw. The anchor is recommended for light duty static applications where holding power is not a critical factor. Ideal for masonry, block and stucco wall applications. It should not be used overhead.



SCREW SIZE	HOLE DIA	RED	BLUE	WHITE	GREEN	PKG
6-8	3/16"	ANCP-3606-JR	ANCB-3606-JR	ANCW-3606-JR	ANCG-3606-JR	100/JAR
6-8	3/16"	ANCP-3606-JRD	ANCB-3606-JRD	ANCW-3606-JRD	ANCG-3606-JRD	500/JAR
6-8	3/16"	ANCP-3606-ML	ANCB-3606-ML	ANCW-3606-ML	ANCG-3606-ML	1000/BAG
10-12	1/4"	ANCP-1410-JR	ANCB-1410-JR	ANCW-1410-JR	ANCG-1410-JR	100/JAR
10-12	1/4"	ANCP-1410-JRD	ANCB-1410-JRD	ANCW-1410-JRD	ANCG-1410-JRD	500/JAR
10-12	1/4"	ANCP-1410-ML	ANCB-1410-ML	ANCW-1410-ML	ANCG-1410-ML	1000/BAG
14-16	5/16"	ANCP-5614-JR	ANCB-5614-JR	ANCW-5614-JR	ANCG-5614-JR	100/JAR
14-16	5/16"	ANCP-5614-JRD	ANCB-5614-JRD	ANCW-5614-JRD	ANCG-5614-JRD	500/JAR
14-16	5/16"	ANCP-5614-ML	ANCB-5614-ML	ANCW-5614-ML	ANCG-5614-ML	1000/BAG

Recommended SDS Masonry Drill Bits



3/16" Part No DBDS-3606

1/4" Part No DBDS-1406

5/16" Part No DBDS-5606

## SUPER RIBBED EXPANDING ANCHOR



Anchors feature expanding plastic shield that expands as the screw is tightened with engineered ribs holding anchor firmly in place. Can be used in all types of base materials including concrete and gypsum drywall

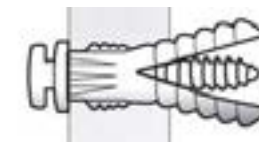

PART NO	SCREW SIZE	HOLE DIA	SDS DRILL BIT	PKG
ANYS-1410-JR	10-12	1/4"	DBDS-1406	100/JAR
ANYS-1410-JRD	10-12	1/4"	DBDS-1406	500/JAR

## SHARKIE™ SELF-MOLDING ANCHORS



The Sharkie wall anchor is engineered for strength - the screw extrudes and compresses the anchor polymer into the wall under tremendous pressure. The anchor molds and conforms exactly to the surface of the hole. All of the forces supported by the screw are transmitted outwardly 360° providing greater holding power by distributing the force over the maximum area possible.



PART NO	SCREW SIZE	HOLE DIA	SDS DRILL BIT	PKG
ANYS-1410-JR	10-12	1/4"	DBDS-1406	100/JAR
ANYS-1410-JRD	10-12	1/4"	DBDS-1406	500/JAR





# SHEET METAL SCREW

## HEX WASHER HEAD



Sheet metal screws, known technically as tapping screws (not to be confused with self-drilling), have sharp threads that cut (or thread) into materials such as plastic, plexi glass, wood, and sheet metal. They are also recommended for use with Conical and Easy Wall Anchors. They make excellent fasteners for attaching metal hardware to wood because the fully threaded shank provides good retention in wood.

AVAILABLE IN



CONTRACTOR BUCKETS

SCREW SIZE	LENGTH	THREAD PITCH	HEX SIZE	STEEL ZINC HEX SLOT/PHIL*	18-8 STAINLESS HEX SLOT	PKG
6	1/2"	18	1/4"	SMHC-0605-JR	S2HX-0605-JR	100/JAR
6	3/4"	18	1/4"	SMHC-0607-JR	S2HX-0607-JR	100/JAR
6	1"	18	1/4"	SMHC-0610-JR	S2HX-0610-JR	100/JAR
6	1-1/4"	18	1/4"	SMHC-0612-JR	S2HX-0612-JR	100/JAR
6	1-1/2"	18	1/4"	SMHC-0615-JR	S2HX-0615-JR	100/JAR
6	2"	18	1/4"	SMHC-0620-JR	S2HX-0620-JR	100/JAR
8	1/2"	15	1/4"	SMHC-0805-JR	S2HX-0805-JR	100/JAR
8	3/4"	15	1/4"	SMHC-0807-JR	S2HX-0807-JR	100/JAR
8	1"	15	1/4"	SMHC-0810-JR	S2HX-0810-JR	100/JAR
8	1-1/4"	15	1/4"	SMHC-0812-JR	S2HX-0812-JR	100/JAR
8	1-1/2"	15	1/4"	SMHC-0815-JR	S2HX-0815-JR	100/JAR
8	2"	15	1/4"	SMHC-0820-JR	S2HX-0820-JR	100/JAR
10	1/2"	12	5/16"	SMHC-1005-JR	S2HX-1005-JR	100/JAR
10	3/4"	12	5/16"	SMHC-1007-JR	S2HX-1007-JR	100/JAR
10	1"	12	5/16"	SMHC-1010-JR	S2HX-1010-JR	100/JAR
10	1-1/4"	12	5/16"	SMHC-1012-JR	S2HX-1012-JR	100/JAR
10	1-1/2"	12	5/16"	SMHC-1015-JR	S2HX-1015-JR	100/JAR
10	2"	12	5/16"	SMHC-1020-JR	S2HX-1020-JR	100/JAR
10	2-1/2"	12	5/16"	SMHC-1025-JR	S2HX-1025-JR	100/JAR
10	3"	12	5/16"	SMHC-1030-JR	S2HX-1030-JR	100/JAR
10	4"	12	5/16"	SMHC-1040-JR	S2HX-1040-JR	50/JAR
12	1/2"	11	5/16"	SMHC-1205-JR	S2HX-1205-JR	100/JAR
12	3/4"	11	5/16"	SMHC-1207-JR	S2HX-1207-JR	100/JAR
12	1"	11	5/16"	SMHC-1210-JR	S2HX-1210-JR	100/JAR
12	1-1/4"	11	5/16"	SMHC-1212-JR	S2HX-1212-JR	100/JAR
12	1-1/2"	11	5/16"	SMHC-1215-JR	S2HX-1215-JR	100/JAR
12	2"	11	5/16"	SMHC-1220-JR	S2HX-1220-JR	100/JAR
12	2-1/2"	11	5/16"	SMHC-1225-JR	S2HX-1225-JR	100/JAR
12	3"	11	5/16"	SMHC-1230-JR	S2HX-1230-JR	100/JAR
12	4"	11	5/16"	SMHC-1240-JR	S2HX-1240-JR	50/JAR
14	1"	10	3/8"	SMHC-1410-JR	S2HX-1410-JR	100/JAR
14	1-1/2"	10	3/8"	SMHC-1415-JR	S2HX-1415-JR	100/JAR
14	2"	10	3/8"	SMHC-1420-JR	S2HX-1420-JR	100/JAR
14	2-1/2"	10	3/8"	SMHC-1425-JR	S2HX-1425-JR	100/JAR
14	3"	10	3/8"	SMHC-1430-JR	S2HX-1430-JR	50/JAR
14	4"	10	3/8"	SMHC-1440-JR	S2HX-1440-JR	50/JAR

\*Slot/Phillips Combo provided where available. Sizes 12 and 14 may be provided in slotted drive only.



# SHEET METAL SCREW

## PAN HEAD PHILLIPS DRIVE



Sheet metal screws, known technically as tapping screws (not to be confused with self-drilling), have sharp threads that cut (or thread) into materials such as plastic, plexi glass, wood, and sheet metal. They are also recommended for use with Conical and Easy Wall Anchors. They make excellent fasteners for attaching metal hardware to wood because the fully threaded shank provides good retention in wood.

AVAILABLE IN



CONTRACTOR BUCKETS

SCREW SIZE	LENGTH	THREAD PITCH	DRIVER SIZE	STEEL ZINC SLOT/PHIL*	18-8 STAINLESS HEX SLOT	PKG
6	1/2"	18	NO2	SMPC-0605-JR	S2PP-0605-JR	100/JAR
6	3/4"	18	NO2	SMPC-0607-JR	S2PP-0607-JR	100/JAR
6	1"	18	NO2	SMPC-0610-JR	S2PP-0610-JR	100/JAR
6	1-1/4"	18	NO2	SMPC-0612-JR	S2PP-0612-JR	100/JAR
6	1-1/2"	18	NO2	SMPC-0615-JR	S2PP-0615-JR	100/JAR
6	2"	18	NO2	SMPC-0620-JR	S2PP-0620-JR	100/JAR
8	1/2"	15	NO2	SMPC-0805-JR	S2PP-0805-JR	100/JAR
8	3/4"	15	NO2	SMPC-0807-JR	S2PP-0807-JR	100/JAR
8	1"	15	NO2	SMPC-0810-JR	S2PP-0810-JR	100/JAR
8	1-1/4"	15	NO2	SMPC-0812-JR	S2PP-0812-JR	100/JAR
8	1-1/2"	15	NO2	SMPC-0815-JR	S2PP-0815-JR	100/JAR
8	2"	15	NO2	SMPC-0820-JR	S2PP-0820-JR	100/JAR
10	1/2"	12	NO2	SMPC-1005-JR	S2PP-1005-JR	100/JAR
10	3/4"	12	NO2	SMPC-1007-JR	S2PP-1007-JR	100/JAR
10	1"	12	NO2	SMPC-1010-JR	S2PP-1010-JR	100/JAR
10	1-1/4"	12	NO2	SMPC-1012-JR	S2PP-1012-JR	100/JAR
10	1-1/2"	12	NO2	SMPC-1015-JR	S2PP-1015-JR	100/JAR
10	2"	12	NO2	SMPC-1020-JR	S2PP-1020-JR	100/JAR
10	2-1/2"	12	NO2	SMPC-1025-JR	S2PP-1025-JR	100/JAR
10	3"	12	NO2	SMPC-1030-JR	S2PP-1030-JR	100/JAR
10	4"	12	NO2	SMPC-1040-JR	S2PP-1040-JR	50/JAR
12	1/2"	11	NO3	SMPC-1205-JR	S2PP-1205-JR	100/JAR
12	3/4"	11	NO3	SMPC-1207-JR	S2PP-1207-JR	100/JAR
12	1"	11	NO3	SMPC-1210-JR	S2PP-1210-JR	100/JAR
12	1-1/4"	11	NO3	SMPC-1212-JR	S2PP-1212-JR	100/JAR
12	1-1/2"	11	NO3	SMPC-1215-JR	S2PP-1215-JR	100/JAR
12	2"	11	NO3	SMPC-1220-JR	S2PP-1220-JR	100/JAR
12	2-1/2"	11	NO3	SMPC-1225-JR	S2PP-1225-JR	100/JAR
12	3"	11	NO3	SMPC-1230-JR	S2PP-1230-JR	100/JAR
12	4"	11	NO3	SMPC-1240-JR	S2PP-1240-JR	50/JAR
14	1"	10	NO3	SMPC-1410-JR	S2PP-1410-JR	100/JAR
14	1-1/2"	10	NO3	SMPC-1415-JR	S2PP-1415-JR	100/JAR
14	2"	10	NO3	SMPC-1420-JR	S2PP-1420-JR	100/JAR
14	2-1/2"	10	NO3	SMPC-1425-JR	S2PP-1425-JR	100/JAR
14	3"	10	NO3	SMPC-1430-JR	S2PP-1430-JR	50/JAR
14	4"	10	NO3	SMPC-1440-JR	S2PP-1440-JR	50/JAR

\*Slot/Phillips Combo provided where available. Sizes 12 and 14 may be provided in phillips drive only.



# SHEET METAL SCREW

## PAN SQUARE DRIVE



Sheet metal screws, known technically as tapping screws (not to be confused with self-drilling), have sharp threads that cut (or thread) into materials such as plastic, plexi glass, wood, and sheet metal. They are also recommended for use with Conical and Easy Wall Anchors. They make excellent fasteners for attaching metal hardware to wood because the fully threaded shank provides good retention in wood.

AVAILABLE IN



CONTRACTOR BUCKETS

SCREW SIZE	LENGTH	THREAD PITCH	DRIVER SIZE	STEEL ZINC SQUARE DRIVE	18-8 STAINLESS SQUARE DRIVE	PKG
6	1/2"	18	NO1	SMPX-0605-JR	S2PX-0605-JR	100/JAR
6	3/4"	18	NO1	SMPX-0607-JR	S2PX-0607-JR	100/JAR
6	1"	18	NO1	SMPX-0610-JR	S2PX-0610-JR	100/JAR
6	1-1/4"	18	NO1	SMPX-0612-JR	S2PX-0612-JR	100/JAR
6	1-1/2"	18	NO1	SMPX-0615-JR	S2PX-0615-JR	100/JAR
6	2"	18	NO1	SMPX-0620-JR	S2PX-0620-JR	100/JAR
8	1/2"	15	NO2	SMPX-0805-JR	S2PX-0805-JR	100/JAR
8	3/4"	15	NO2	SMPX-0807-JR	S2PX-0807-JR	100/JAR
8	1"	15	NO2	SMPX-0810-JR	S2PX-0810-JR	100/JAR
8	1-1/4"	15	NO2	SMPX-0812-JR	S2PX-0812-JR	100/JAR
8	1-1/2"	15	NO2	SMPX-0815-JR	S2PX-0815-JR	100/JAR
8	2"	15	NO2	SMPX-0820-JR	S2PX-0820-JR	100/JAR
10	1/2"	12	NO2	SMPX-1005-JR	S2PX-1005-JR	100/JAR
10	3/4"	12	NO2	SMPX-1007-JR	S2PX-1007-JR	100/JAR
10	1"	12	NO2	SMPX-1010-JR	S2PX-1010-JR	100/JAR
10	1-1/4"	12	NO2	SMPX-1012-JR	S2PX-1012-JR	100/JAR
10	1-1/2"	12	NO2	SMPX-1015-JR	S2PX-1015-JR	100/JAR
10	2"	12	NO2	SMPX-1020-JR	S2PX-1020-JR	100/JAR
12	1/2"	11	NO3	SMPX-1205-JR	S2PX-1205-JR	100/JAR
12	3/4"	11	NO3	SMPX-1207-JR	S2PX-1207-JR	100/JAR
12	1"	11	NO3	SMPX-1210-JR	S2PX-1210-JR	100/JAR
12	1-1/4"	11	NO3	SMPX-1212-JR	S2PX-1212-JR	100/JAR
12	1-1/2"	11	NO3	SMPX-1215-JR	S2PX-1215-JR	100/JAR
12	2"	11	NO3	SMPX-1220-JR	S2PX-1220-JR	100/JAR
12	2-1/2"	11	NO3	SMPX-1225-JR	S2PX-1225-JR	100/JAR

## SELF-TAPPING VS SELF-DRILLING

It can be a confusing conversation, self tapping, tapping, self-drilling...customers ask for one thing when they mean another. Our sheet metal screw is technically known as a tapping (or self-tapping) screw, where the sharp end is inserted through an existing hole or penetrates thin sheel metal and "taps" threads as a means of fastening to the material. Alternatively, a self-drilling screw (often referred to as a Tek™ screw), has a hardened drill point ranging from #2 through #5 in length for varying thicknesses of material.

# SELF-DRILLING SCREWS



## HEX WASHER HEAD #2 - #3 POINT



Self-Drilling Screws eliminate the need for a pre-drilled hole. New and Improved design provides up to 30% faster drill times and less kick-out.

Available in zinc plated and 410 stainless steel.

AVAILABLE IN



CONTRACTOR BUCKETS

SCREW SIZE	LENGTH	THREAD PITCH	HEAD SIZE	DRILL POINT	MAX THICKNESS	STEEL ZINC HEX WASHER HD	410 STAINLESS HEX WASHER HD	PKG
6	3/8"	18	1/4"	#2	.100	SMTK-0603-JR	S2TK-0603-JR	100/JAR
6	1/2"	18	1/4"	#2	.100	SMTK-0605-JR	S2TK-0605-JR	100/JAR
6	3/4"	18	1/4"	#2	.100	SMTK-0607-JR	S2TK-0607-JR	100/JAR
6	1"	18	1/4"	#2	.100	SMTK-0610-JR	S2TK-0610-JR	100/JAR
6	1-1/4"	18	1/4"	#2	.100	SMTK-0612-JR	S2TK-0612-JR	100/JAR
6	1-1/2"	18	1/4"	#2	.100	SMTK-0615-JR	S2TK-0615-JR	100/JAR
6	2"	18	1/4"	#2	.100	SMTK-0620-JR	S2TK-0620-JR	100/JAR
8	1/2"	15	1/4"	#2	.100	SMTK-0805-JR	S2TK-0805-JR	100/JAR
8	3/4"	15	1/4"	#2	.100	SMTK-0807-JR	S2TK-0807-JR	100/JAR
8	1"	15	1/4"	#2	.100	SMTK-0810-JR	S2TK-0810-JR	100/JAR
8	1-1/4"	15	1/4"	#2	.100	SMTK-0812-JR	S2TK-0812-JR	100/JAR
8	1-1/2"	15	1/4"	#2	.100	SMTK-0815-JR	S2TK-0815-JR	100/JAR
8	2"	15	1/4"	#2	.100	SMTK-0820-JR	S2TK-0820-JR	100/JAR
10	1/2"	12	5/16"	#3	.175	SMTK-1005-JR	S2TK-1005-JR	100/JAR
10	3/4"	12	5/16"	#3	.175	SMTK-1007-JR	S2TK-1007-JR	100/JAR
10	1"	12	5/16"	#3	.175	SMTK-1010-JR	S2TK-1010-JR	100/JAR
10	1-1/4"	12	5/16"	#3	.175	SMTK-1012-JR	S2TK-1012-JR	100/JAR
10	1-1/2"	12	5/16"	#3	.175	SMTK-1015-JR	S2TK-1015-JR	100/JAR
10	2"	12	5/16"	#3	.175	SMTK-1020-JR	S2TK-1020-JR	100/JAR
12	1/2"	11	5/16"	#3	.210	SMTK-1205-JR	S2TK-1205-JR	100/JAR
12	3/4"	11	5/16"	#3	.210	SMTK-1207-JR	S2TK-1207-JR	100/JAR
12	1"	11	5/16"	#3	.210	SMTK-1210-JR	S2TK-1210-JR	100/JAR
12	1-1/4"	11	5/16"	#3	.210	SMTK-1212-JR	S2TK-1212-JR	100/JAR
12	1-1/2"	11	5/16"	#3	.210	SMTK-1215-JR	S2TK-1215-JR	100/JAR
12	2"	11	5/16"	#3	.210	SMTK-1220-JR	S2TK-1220-JR	100/JAR
14	3/4"	10	3/8"	#3	.250	SMTK-1407-JR	S2TK-1407-JR	100/JAR
14	1"	10	3/8"	#3	.250	SMTK-1410-JR	S2TK-1410-JR	100/JAR
14	1-1/2"	10	3/8"	#3	.250	SMTK-1415-JR	S2TK-1415-JR	100/JAR
14	2"	10	3/8"	#3	.250	SMTK-1420-JR	S2TK-1420-JR	100/JAR

## HEX WASHER HEAD #4 - #5 POINT



Self-Drilling Screws eliminate the need for a pre-drilled hole. Longer drill flutes allow for use with thicker steel up to 1/2" (excluding #4 Pt). Ceramic zinc coating provides up to 1000 hour salt spray protection.

SCREW SIZE	OVERALL LENGTH	THREAD LENGTH	THREAD PITCH	DRILL POINT	MAX THICKNESS	HEX SIZE	STEEL DACRO HEX WASHER HD	PKG
12	7/8"	7/16"	24	#4	.250	5/16"	SMTK-1287-4-JR	100/JAR
12	1-1/4"	5/8"	24	#5	.500	5/16"	SMTK-1212-5-JR	100/JAR
12	1-1/2"	7/8"	24	#5	.500	5/16"	SMTK-1215-5-JR	100/JAR
12	2"	1-3/8"	24	#5	.500	5/16"	SMTK-1220-5-JR	100/JAR





# SELF-DRILLING SCREWS

## PAN PHILLIPS DRIVE #2 - #3 POINT



Self-Drilling Screws eliminate the need for a pre-drilled hole. New and Improved design provides up to 30% faster drill times and less kick-out.

Available in zinc plated and 410 stainless steel.

AVAILABLE IN



CONTRACTOR BUCKETS

SCREW SIZE	LENGTH	THREAD PITCH	HEAD SIZE	DRILL POINT	MAX THICKNESS	STEEL ZINC HEX WASHER HD	410 STAINLESS HEX WASHER HD	PKG
6	3/8"	18	1/4"	#2	.100	SMTTP-0603-JR	S2TP-0603-JR	100/JAR
6	1/2"	18	1/4"	#2	.100	SMTTP-0605-JR	S2TP-0605-JR	100/JAR
6	3/4"	18	1/4"	#2	.100	SMTTP-0607-JR	S2TP-0607-JR	100/JAR
6	1"	18	1/4"	#2	.100	SMTTP-0610-JR	S2TP-0610-JR	100/JAR
6	1-1/4"	18	1/4"	#2	.100	SMTTP-0612-JR	S2TP-0612-JR	100/JAR
6	1-1/2"	18	1/4"	#2	.100	SMTTP-0615-JR	S2TP-0615-JR	100/JAR
6	2"	18	1/4"	#2	.100	SMTTP-0620-JR	S2TP-0620-JR	100/JAR
8	1/2"	15	1/4"	#2	.100	SMTTP-0805-JR	S2TP-0805-JR	100/JAR
8	3/4"	15	1/4"	#2	.100	SMTTP-0807-JR	S2TP-0807-JR	100/JAR
8	1"	15	1/4"	#2	.100	SMTTP-0810-JR	S2TP-0810-JR	100/JAR
8	1-1/4"	15	1/4"	#2	.100	SMTTP-0812-JR	S2TP-0812-JR	100/JAR
8	1-1/2"	15	1/4"	#2	.100	SMTTP-0815-JR	S2TP-0815-JR	100/JAR
8	2"	15	1/4"	#2	.100	SMTTP-0820-JR	S2TP-0820-JR	100/JAR
10	1/2"	12	5/16"	#3	.175	SMTTP-1005-JR	S2TP-1005-JR	100/JAR
10	3/4"	12	5/16"	#3	.175	SMTTP-1007-JR	S2TP-1007-JR	100/JAR
10	1"	12	5/16"	#3	.175	SMTTP-1010-JR	S2TP-1010-JR	100/JAR
10	1-1/4"	12	5/16"	#3	.175	SMTTP-1012-JR	S2TP-1012-JR	100/JAR
10	1-1/2"	12	5/16"	#3	.175	SMTTP-1015-JR	S2TP-1015-JR	100/JAR
10	2"	12	5/16"	#3	.175	SMTTP-1020-JR	S2TP-1020-JR	100/JAR
12	1/2"	11	5/16"	#3	.210	SMTTP-1205-JR	S2TP-1205-JR	100/JAR
12	3/4"	11	5/16"	#3	.210	SMTTP-1207-JR	S2TP-1207-JR	100/JAR
12	1"	11	5/16"	#3	.210	SMTTP-1210-JR	S2TP-1210-JR	100/JAR
12	1-1/4"	11	5/16"	#3	.210	SMTTP-1212-JR	S2TP-1212-JR	100/JAR
12	1-1/2"	11	5/16"	#3	.210	SMTTP-1215-JR	S2TP-1215-JR	100/JAR
12	2"	11	5/16"	#3	.210	SMTTP-1220-JR	S2TP-1220-JR	100/JAR
14	3/4"	10	3/8"	#3	.250	SMTTP-1407-JR	S2TP-1407-JR	100/JAR
14	1"	10	3/8"	#3	.250	SMTTP-1410-JR	S2TP-1410-JR	100/JAR
14	1-1/2"	10	3/8"	#3	.250	SMTTP-1415-JR	S2TP-1415-JR	100/JAR
14	2"	10	3/8"	#3	.250	SMTTP-1420-JR	S2TP-1420-JR	100/JAR

## HEX WASHER HEAD w/NEO WASHER #4 - #5 POINT



Self-Drilling Screws eliminate the need for a pre-drilled hole. Longer drill flutes allow for use with thicker steel up to 1/2" (excluding #4 Pt). Ceramic zinc coating provides up to 1000 hour salt spray protection.

SCREW SIZE	OVERALL LENGTH	THREAD LENGTH	THREAD PITCH	DRILL POINT	MAX THICKNESS	HEX SIZE	STEEL DACRO HEX WASHER HD	PKG
12	7/8"	7/16"	24	#4	.250	5/16"	SMTK-1287-4-NB-JR	100/JAR
12	1-1/4"	5/8"	24	#5	.500	5/16"	SMTK-1212-5-NB-JR	100/JAR
12	1-1/2"	7/8"	24	#5	.500	5/16"	SMTK-1215-5-NB-JR	100/JAR
12	2"	1-3/8"	24	#5	.500	5/16"	SMTK-1220-5-NB-JR	100/JAR



# WAFER HEAD SCREWS

## NEEDLE POINT MODIFIED TRUSS



Needle Point Wafer Sheet Metal Screws are metal piercing and will tap up to 20 gauge steel studs. The phillips wafer head provides large bearing surface. Used for framing, electrical, plumbing and sheet metal applications.

SCREW SIZE	LENGTH	THREAD PITCH	STEEL ZINC HEX WASHER HD	18-8 STAINLESS HEX WASHER HD	PKG
8	1/2"	15	SWKS-0805-JR	S2KS-0805-JR	100/JAR
8	9/16"	15	SWKS-0896-JR	S2KS-0896-JR	100/JAR
8	3/4"	15	SWKS-0807-JR	S2KS-0807-JR	100/JAR
8	1"	15	SWKS-0810-JR	S2KS-0810-JR	100/JAR
8	1-1/2"	15	SWKS-0815-JR	S2KS-0815-JR	100/JAR
8	2"	15	SWKS-0820-JR	S2KS-0820-JR	100/JAR

Select sizes are available in contractor bulk buckets. Please consult price list for details.



AVAILABLE IN

CONTRACTOR BUCKETS

## SELF-DRILLING MODIFIED TRUSS



Self drilling Wafer Sheet Metal Screws self-drill a hole and tap threads in one operation. The drilling operation removes metal and can be used with heavier gauge metals. #2 Drill Point for sheet metals and low density substrates.

SCREW SIZE	LENGTH	THREAD PITCH	MAX THICKNESS	STEEL ZINC HEX WASHER HD	410 STAINLESS HEX WASHER HD	PKG
8	1/2"	18	.100	SWKT-0805-JR	S2KT-0805-JR	100/JAR
8	3/4"	18	.100	SWKT-0807-JR	S2KT-0807-JR	100/JAR
8	1"	18	.100	SWKT-0810-JR	S2KT-0810-JR	100/JAR
8	1-1/4"	18	.100	SWKT-0812-JR	S2KT-0812-JR	100/JAR
8	1-5/8"	18	.100	SWKT-0816-JR	S2KT-0816-JR	100/JAR
8	2"	18	.100	SWKT-0820-JR	S2KT-0820-JR	100/JAR

Select sizes are available in contractor bulk buckets. Please consult price list for details.



AVAILABLE IN

CONTRACTOR BUCKETS

# FRAMING SCREWS

## NEEDLE POINT



Needle Point Framing Screws are ideal for light duty aluminum and steel metal to metal applications. Will penetrate through 20 gauge steel studs. Black oxide finish.

SCREW SIZE	LENGTH	THREAD PITCH	STEEL ZINC HEX WASHER HD	PKG
7	7/16"	18	FRSC-7716-JR	100/JAR

Select sizes are available in contractor bulk buckets. Please consult price list for details.



AVAILABLE IN

CONTRACTOR BUCKETS

## SELF-DRILLING



Self-Drilling Framing Screws are ideal for light duty aluminum and steel metal to metal applications. Will penetrate to 20 gauge steel studs. Zinc plated finish.

SCREW SIZE	LENGTH	DRILL POINT	THREAD PITCH	STEEL ZINC HEX WASHER HD	PKG
7	7/16"	#2	18	FRTK-7716-JR	100/JAR

Select sizes are available in contractor bulk buckets. Please consult price list for details.



AVAILABLE IN

CONTRACTOR BUCKETS



# DRYWALL SCREWS

## COARSE THREAD BLACK PHOSPHATE

Coarse thread Bugle Head drywall screws are self piercing and are used for drywall, particle board and wood. The coarse threads provide for a quicker installation.

SCREW SIZE	LENGTH	THREAD PITCH	COARSE BLACK PHOSPHATE	COARSE YELLOW ZINC	PKG
6	1"	9	DWFP-0610-JR	DYFP-0610-JR	100/JAR
6	1-1/4"	9	DWFP-0612-JR	DYFP-0612-JR	100/JAR
6	1-5/8"	9	DWFP-0616-JR	DYFP-0616-JR	100/JAR
6	2"	9	DWFP-0620-JR	DYFP-0620-JR	100/JAR
8	2-1/2"	8	DWFP-0825-JR	DYFP-0825-JR	100/JAR
8	3"	8	DWFP-0830-JR	DYFP-0830-JR	100/JAR

Select sizes are available in contractor bulk buckets. Please consult price list for details.

AVAILABLE IN



CONTRACTOR BUCKETS

## FINE THREAD BLACK PHOSPHATE

Fine thread Bugle Head drywall screws are self piercing and are used for wood, drywall and aluminum.

SCREW SIZE	LENGTH	THREAD PITCH	COARSE BLACK PHOSPHATE	PKG
6	1"	9	DWFP-0610-FT-JR	100/JAR
6	1-1/4"	9	DWFP-0612-FT-JR	100/JAR
6	1-5/8"	9	DWFP-0616-FT-JR	100/JAR
6	2"	9	DWFP-0620-FT-JR	100/JAR
8	2-1/2"	8	DWFP-0825-FT-JR	100/JAR
8	3"	8	DWFP-0830-FT-JR	100/JAR

Select sizes are available in contractor bulk buckets. Please consult price list for details.

AVAILABLE IN



CONTRACTOR BUCKETS

# WOOD SCREWS

Wood Screws are used primarily for connecting wood to wood and are known for the clamping force that they provide to strengthen a joint. They are also used to attach hardware, hinges, locks and other items to wood.

SCREW SIZE	LENGTH	ZINC PLATED	PKG
8	1/2"	WLFP-0805	100/JAR
8	3/4"	WLFP-0807	100/JAR
8	1"	WLFP-0810	100/JAR
10	1-1/2"	WLFP-1015	100/JAR
10	2"	WLFP-1020	100/JAR
10	3"	WLFP-1030	100/JAR



Visit us on the web at  
[www.posi-tech.com](http://www.posi-tech.com)



# MACHINE SCREWS

## ROUND HEAD SLOT/PHILLIPS COMBO DRIVE

Machine screws are used with nuts or screwed directly into a threaded receptacle to fasten metal parts together. If nuts are needed, use with nuts of the same finish and threading for proper fit.

Listed lengths are measured from the bottom of the head.

SCREW SIZE	THREAD PITCH	LENGTH	PHILLIPS SIZE	STEEL ZINC	PAN PHILLIPS 18-8 STAINLESS	PKG
6	32	1/2"	NO.2	MSRC-6305	M2PP-6305	100/JAR
6	32	3/4"	NO.2	MSRC-6307	M2PP-6307	100/JAR
6	32	1"	NO.2	MSRC-6310	M2PP-6310	100/JAR
6	32	1-1/4"	NO.2	MSRC-6312	M2PP-6312	100/JAR
6	32	1-1/2"	NO.2	MSRC-6315	M2PP-6315	100/JAR
6	32	2"	NO.2	MSRC-6320	M2PP-6320	100/JAR
6	32	2-1/2"	NO.2	MSRC-6325	M2PP-6325	100/JAR
6	32	3"	NO.2	MSRC-6330	M2PP-6330	100/JAR
6	32	4"	NO.2	MSRC-6340	M2PP-6340	100/JAR

8	32	1/2"	NO.2	MSRC-8305	M2PP-8305	100/JAR
8	32	3/4"	NO.2	MSRC-8307	M2PP-8307	100/JAR
8	32	1"	NO.2	MSRC-8310	M2PP-8310	100/JAR
8	32	1-1/4"	NO.2	MSRC-8312	M2PP-8312	100/JAR
8	32	1-1/2"	NO.2	MSRC-8315	M2PP-8315	100/JAR
8	32	2"	NO.2	MSRC-8320	M2PP-8320	100/JAR
8	32	2-1/2"	NO.2	MSRC-8325	M2PP-8325	100/JAR
8	32	3"	NO.2	MSRC-8330	M2PP-8330	100/JAR

10	24	1/2"	NO.2	MSRC-1205	M2PP-1205	100/JAR
10	24	3/4"	NO.2	MSRC-1207	M2PP-1207	100/JAR
10	24	1"	NO.2	MSRC-1210	M2PP-1210	100/JAR
10	24	1-1/4"	NO.2	MSRC-1212	M2PP-1212	100/JAR
10	24	1-1/2"	NO.2	MSRC-1215	M2PP-1215	100/JAR
10	24	2"	NO.2	MSRC-1220	M2PP-1220	100/JAR
10	24	2-1/2"	NO.2	MSRC-1225	M2PP-1225	100/JAR
10	24	3"	NO.2	MSRC-1230	M2PP-1230	100/JAR
10	24	4"	NO.2	MSRC-1240	M2PP-1240	100/JAR

10	32	1/2"	NO.2	MSRC-1305	M2PP-1305	100/JAR
10	32	3/4"	NO.2	MSRC-1307	M2PP-1307	100/JAR
10	32	1"	NO.2	MSRC-1310	M2PP-1310	100/JAR
10	32	1-1/4"	NO.2	MSRC-1312	M2PP-1312	100/JAR
10	32	1-1/2"	NO.2	MSRC-1315	M2PP-1315	100/JAR
10	32	2"	NO.2	MSRC-1320	M2PP-1320	100/JAR
10	32	2-1/2"	NO.2	MSRC-1325	M2PP-1325	100/JAR
10	32	3"	NO.2	MSRC-1330	M2PP-1330	100/JAR
10	32	4"	NO.2	MSRC-1340	M2PP-1340	100/JAR

Continued on Next Page





# MACHINE SCREWS



## ROUND HEAD SLOT/PHILLIPS COMBO DRIVE



Machine screws are used with nuts or screwed directly into a threaded receptacle to fasten metal parts together. If nuts are needed, use with nuts of the same finish and threading for proper fit.

Listed lengths are measured from the bottom of the head.

SCREW SIZE	THREAD PITCH	LENGTH	PHILLIPS SIZE	STEEL ZINC	PAN PHILLIPS 18-8 STAINLESS	PKG
1/4"	20	1/2"	NO. 3	MSRC-1405	M2PP-1405	100/JAR
1/4"	20	3/4"	NO. 3	MSRC-1407	M2PP-1407	100/JAR
1/4"	20	1"	NO. 3	MSRC-1410	M2PP-1410	100/JAR
1/4"	20	1-1/4"	NO. 3	MSRC-1412	M2PP-1412	100/JAR
1/4"	20	1-1/2"	NO. 3	MSRC-1415	M2PP-1415	100/JAR
1/4"	20	2"	NO. 3	MSRC-1420	M2PP-1420	100/JAR
1/4"	20	2-1/2"	NO. 3	MSRC-1425	M2PP-1425	100/JAR
1/4"	20	3"	NO. 3	MSRC-1430	M2PP-1430	100/JAR
1/4"	20	4"	NO. 3	MSRC-1440	M2PP-1440	100/JAR



## FLAT HEAD PHILLIPS DRIVE



Machine screws are used with nuts or screwed directly into a threaded nut or insert to fasten metal parts together. If nuts are needed, use with nuts of the same finish and threading for proper fit.

Listed lengths are measured from the top of the head.

SCREW SIZE	THREAD PITCH	LENGTH	PHILLIPS SIZE	STEEL ZINC	PAN PHILLIPS 18-8 STAINLESS	PKG
6	32	1/2"	NO. 2	MSFP-6305	M2FP-6305	100/JAR
6	32	3/4"	NO. 2	MSFP-6307	M2FP-6307	100/JAR
6	32	1"	NO. 2	MSFP-6310	M2FP-6310	100/JAR
6	32	1-1/4"	NO. 2	MSFP-6312	M2FP-6312	100/JAR
6	32	1-1/2"	NO. 2	MSFP-6315	M2FP-6315	100/JAR
6	32	2"	NO. 2	MSFP-6320	M2FP-6320	100/JAR
6	32	2-1/2"	NO. 2	MSFP-6325	M2FP-6325	100/JAR
6	32	3"	NO. 2	MSFP-6330	M2FP-6330	100/JAR
6	32	4"	NO. 2	MSFP-6340	M2FP-6340	100/JAR
8	32	1/2"	NO. 2	MSFP-8305	M2FP-8305	100/JAR
8	32	3/4"	NO. 2	MSFP-8307	M2FP-8307	100/JAR
8	32	1"	NO. 2	MSFP-8310	M2FP-8310	100/JAR
8	32	1-1/4"	NO. 2	MSFP-8312	M2FP-8312	100/JAR
8	32	1-1/2"	NO. 2	MSFP-8315	M2FP-8315	100/JAR
8	32	2"	NO. 2	MSFP-8320	M2FP-8320	100/JAR
8	32	2-1/2"	NO. 2	MSFP-8325	M2FP-8325	100/JAR
8	32	3"	NO. 2	MSFP-8330	M2FP-8330	100/JAR
8	32	4"	NO. 2	MSFP-8340	M2FP-8340	100/JAR



# HEX CAP SCREWS



Hex Head Cap Screws, are bolts with a hexagonal or six sided head. Hex cap screws feature a washer surface directly under the head which creates a better seal and a chamfered tip for an easier insertion from different angles.

SCREW SIZE	THREAD PITCH	LENGTH	GRADE 2 ZINC PLATED	18-8 STAINLESS	316 STAINLESS	PKG
1/4"	20	1/2"	HCGA-1405-JR	H2GA-1405-JR	H3GA-1405-JR	100/JAR
1/4"	20	3/4"	HCGA-1407-JR	H2GA-1407-JR	H3GA-1407-JR	100/JAR
1/4"	20	1"	HCGA-1410-JR	H2GA-1410-JR	H3GA-1410-JR	100/JAR
1/4"	20	1-1/4"	HCGA-1412-JR	H2GA-1412-JR	H3GA-1412-JR	100/JAR
1/4"	20	1-1/2"	HCGA-1415-JR	H2GA-1415-JR	H3GA-1415-JR	100/JAR
1/4"	20	2"	HCGA-1420-JR	H2GA-1420-JR	H3GA-1420-JR	100/JAR
1/4"	20	2-1/2"	HCGA-1425-JR	H2GA-1425-JR	H3GA-1425-JR	100/JAR
1/4"	20	3"	HCGA-1430-JR	H2GA-1430-JR	H3GA-1430-JR	100/JAR
1/4"	20	4"	HCGA-1440-JR	H2GA-1440-JR	H3GA-1440-JR	100/JAR

Fully threaded up to 1" in length

5/16"	18	1/2"	HCGA-5605-JR	H2GA-5605-JR	H3GA-5605-JR	100/JAR
5/16"	18	3/4"	HCGA-5607-JR	H2GA-5607-JR	H3GA-5607-JR	100/JAR
5/16"	18	1"	HCGA-5610-JR	H2GA-5610-JR	H3GA-5610-JR	100/JAR
5/16"	18	1-1/4"	HCGA-5612-JR	H2GA-5612-JR	H3GA-5612-JR	100/JAR
5/16"	18	1-1/2"	HCGA-5615-JR	H2GA-5615-JR	H3GA-5615-JR	100/JAR
5/16"	18	2"	HCGA-5620-JR	H2GA-5620-JR	H3GA-5620-JR	100/JAR
5/16"	18	2-1/2"	HCGA-5625-JR	H2GA-5625-JR	H3GA-5625-JR	100/JAR
5/16"	18	3"	HCGA-5630-JR	H2GA-5630-JR	H3GA-5630-JR	100/JAR
5/16"	18	4"	HCGA-5640-JR	H2GA-5640-JR	H3GA-5640-JR	100/JAR

Fully threaded up to 1-1/4" in length

3/8"	16	1/2"	HCGA-3805-JR	H2GA-3805-JR	H3GA-3805-JR	100/JAR
3/8"	16	3/4"	HCGA-3807-JR	H2GA-3807-JR	H3GA-3807-JR	100/JAR
3/8"	16	1"	HCGA-3810-JR	H2GA-3810-JR	H3GA-3810-JR	100/JAR
3/8"	16	1-1/4"	HCGA-3812-JR	H2GA-3812-JR	H3GA-3812-JR	100/JAR
3/8"	16	1-1/2"	HCGA-3815-JR	H2GA-3815-JR	H3GA-3815-JR	100/JAR
3/8"	16	2"	HCGA-3820-JR	H2GA-3820-JR	H3GA-3820-JR	100/JAR
3/8"	16	2-1/2"	HCGA-3825-JR	H2GA-3825-JR	H3GA-3825-JR	50/JAR
3/8"	16	3"	HCGA-3830-JR	H2GA-3830-JR	H3GA-3830-JR	50/JAR
3/8"	16	4"	HCGA-3840-JR	H2GA-3840-JR	H3GA-3840-JR	50/JAR

Fully threaded up to 1-1/4" in length

1/2"	13	1/2"	HCGA-1205-JR	H2GA-1205-JR	H3GA-1205-JR	50/JAR
1/2"	13	3/4"	HCGA-1207-JR	H2GA-1207-JR	H3GA-1207-JR	50/JAR
1/2"	13	1"	HCGA-1210-JR	H2GA-1210-JR	H3GA-1210-JR	50/JAR
1/2"	13	1-1/4"	HCGA-1212-JR	H2GA-1212-JR	H3GA-1212-JR	50/JAR
1/2"	13	1-1/2"	HCGA-1215-JR	H2GA-1215-JR	H3GA-1215-JR	50/JAR
1/2"	13	2"	HCGA-1220-JR	H2GA-1220-JR	H3GA-1220-JR	50/JAR
1/2"	13	2-1/2"	HCGA-1225-JR	H2GA-1225-JR	H3GA-1225-JR	50/JAR
1/2"	13	3"	HCGA-1230-JR	H2GA-1230-JR	H3GA-1230-JR	50/JAR
1/2"	13	4"	HCGA-1240-JR	H2GA-1240-JR	H3GA-1240-JR	50/JAR

Fully threaded up to 1-1/2" in length





# HEX TAP BOLTS



Tap bolts are fully threaded hex head fasteners able to accommodate multiple joint thicknesses. Tap bolts may be a good choice when bolt thread length needed is unknown. Not recommended for use where more than one

SCREW SIZE	THREAD PITCH	LENGTH	GRADE 2 ZINC PLATED	18-8 STAINLESS	PKG
1/4"	20	1/2"	HCBT-1405-JR	H2BT-1405-JR	100/JAR
1/4"	20	3/4"	HCBT-1407-JR	H2BT-1407-JR	100/JAR
1/4"	20	1"	HCBT-1410-JR	H2BT-1410-JR	100/JAR
1/4"	20	1-1/4"	HCBT-1412-JR	H2BT-1412-JR	100/JAR
1/4"	20	1-1/2"	HCBT-1415-JR	H2BT-1415-JR	100/JAR
1/4"	20	2"	HCBT-1420-JR	H2BT-1420-JR	100/JAR
1/4"	20	2-1/2"	HCBT-1425-JR	H2BT-1425-JR	100/JAR
1/4"	20	3"	HCBT-1430-JR	H2BT-1430-JR	100/JAR
1/4"	20	4"	HCBT-1440-JR	H2BT-1440-JR	100/JAR



5/16"	18	1/2"	HCBT-5605-JR	H2BT-5605-JR	100/JAR
5/16"	18	3/4"	HCBT-5607-JR	H2BT-5607-JR	100/JAR
5/16"	18	1"	HCBT-5610-JR	H2BT-5610-JR	100/JAR
5/16"	18	1-1/4"	HCBT-5612-JR	H2BT-5612-JR	100/JAR
5/16"	18	1-1/2"	HCBT-5615-JR	H2BT-5615-JR	100/JAR
5/16"	18	2"	HCBT-5620-JR	H2BT-5620-JR	100/JAR
5/16"	18	2-1/2"	HCBT-5625-JR	H2BT-5625-JR	100/JAR
5/16"	18	3"	HCBT-5630-JR	H2BT-5630-JR	100/JAR
5/16"	18	4"	HCBT-5640-JR	H2BT-5640-JR	100/JAR

3/8"	16	1/2"	HCBT-3805-JR	H2BT-3805-JR	100/JAR
3/8"	16	3/4"	HCBT-3807-JR	H2BT-3807-JR	100/JAR
3/8"	16	1"	HCBT-3810-JR	H2BT-3810-JR	100/JAR
3/8"	16	1-1/4"	HCBT-3812-JR	H2BT-3812-JR	100/JAR
3/8"	16	1-1/2"	HCBT-3815-JR	H2BT-3815-JR	100/JAR
3/8"	16	2"	HCBT-3820-JR	H2BT-3820-JR	100/JAR
3/8"	16	2-1/2"	HCBT-3825-JR	H2BT-3825-JR	50/JAR
3/8"	16	3"	HCBT-3830-JR	H2BT-3830-JR	50/JAR
3/8"	16	4"	HCBT-3840-JR	H2BT-3840-JR	50/JAR

1/2"	13	1/2"	HCBT-1205-JR	H2BT-1205-JR	50/JAR
1/2"	13	3/4"	HCBT-1207-JR	H2BT-1207-JR	50/JAR
1/2"	13	1"	HCBT-1210-JR	H2BT-1210-JR	50/JAR
1/2"	13	1-1/4"	HCBT-1212-JR	H2BT-1212-JR	50/JAR
1/2"	13	1-1/2"	HCBT-1215-JR	H2BT-1215-JR	50/JAR
1/2"	13	2"	HCBT-1220-JR	H2BT-1220-JR	50/JAR
1/2"	13	2-1/2"	HCBT-1225-JR	H2BT-1225-JR	50/JAR
1/2"	13	3"	HCBT-1230-JR	H2BT-1230-JR	50/JAR
1/2"	13	4"	HCBT-1240-JR	H2BT-1240-JR	50/JAR

# LAG BOLTS



Lag screws, also known as lag bolts, are used in wood construction for heavier load applications than most wood screws can support. Pre-Drilling is recommended for best results.

SCREW SIZE	LENGTH	DRIVE SIZE	GRADE 2 ZINC PLATED	18-8 STAINLESS	PKG
1/4"	1"	7/16"	LASZ-1410-JR	L2SZ-1410-JR	100/JAR
1/4"	1-1/4"	7/16"	LASZ-1412-JR	L2SZ-1412-JR	100/JAR
1/4"	1-1/2"	7/16"	LASZ-1415-JR	L2SZ-1415-JR	100/JAR
1/4"	2"	7/16"	LASZ-1420-JR	L2SZ-1420-JR	100/JAR
1/4"	2-1/2"	7/16"	LASZ-1425-JR	L2SZ-1425-JR	100/JAR
1/4"	3"	7/16"	LASZ-1430-JR	L2SZ-1430-JR	100/JAR
1/4"	4"	7/16"	LASZ-1440-JR	L2SZ-1440-JR	100/JAR
1/4"	5"	7/16"	LASZ-1450-JR	L2SZ-1450-JR	50/JAR
1/4"	6"	7/16"	LASZ-1460-JR	L2SZ-1460-JR	50/JAR



Pilot Hole Sizes: Softwood = 3/16" Hardwood = 7/32"

5/16"	1/2"	1/2"	LASZ-5605-JR	L2SZ-5605-JR	100/JAR
5/16"	3/4"	1/2"	LASZ-5607-JR	L2SZ-5607-JR	100/JAR
5/16"	1"	1/2"	LASZ-5610-JR	L2SZ-5610-JR	100/JAR
5/16"	1-1/4"	1/2"	LASZ-5612-JR	L2SZ-5612-JR	100/JAR
5/16"	1-1/2"	1/2"	LASZ-5615-JR	L2SZ-5615-JR	100/JAR
5/16"	2"	1/2"	LASZ-5620-JR	L2SZ-5620-JR	100/JAR
5/16"	2-1/2"	1/2"	LASZ-5625-JR	L2SZ-5625-JR	100/JAR
5/16"	3"	1/2"	LASZ-5630-JR	L2SZ-5630-JR	100/JAR
5/16"	4"	1/2"	LASZ-5640-JR	L2SZ-5640-JR	100/JAR

Pilot Hole Sizes: Softwood = 9/64" Hardwood = 13/64"

3/8"	1"	9/16"	LASZ-3810-JR	L2SZ-3810-JR	100/JAR
3/8"	1-1/4"	9/16"	LASZ-3812-JR	L2SZ-3812-JR	100/JAR
3/8"	1-1/2"	9/16"	LASZ-3815-JR	L2SZ-3815-JR	100/JAR
3/8"	2"	9/16"	LASZ-3820-JR	L2SZ-3820-JR	100/JAR
3/8"	2-1/2"	9/16"	LASZ-3825-JR	L2SZ-3825-JR	50/JAR
3/8"	3"	9/16"	LASZ-3830-JR	L2SZ-3830-JR	50/JAR
3/8"	4"	9/16"	LASZ-3840-JR	L2SZ-3840-JR	50/JAR
3/8"	5"	9/16"	LASZ-3850-JR	L2SZ-3850-JR	25/JAR
3/8"	6"	9/16"	LASZ-3860-JR	L2SZ-3860-JR	25/JAR

Pilot Hole Sizes: Softwood = 9/32" Hardwood = 5/16"

1/2"	1-1/4"	3/4"	LASZ-1212-JR	L2SZ-1212-JR	50/JAR
1/2"	1-1/2"	3/4"	LASZ-1215-JR	L2SZ-1215-JR	50/JAR
1/2"	2"	3/4"	LASZ-1220-JR	L2SZ-1220-JR	50/JAR
1/2"	2-1/2"	3/4"	LASZ-1225-JR	L2SZ-1225-JR	50/JAR
1/2"	3"	3/4"	LASZ-1230-JR	L2SZ-1230-JR	50/JAR
1/2"	4"	3/4"	LASZ-1240-JR	L2SZ-1240-JR	50/JAR
1/2"	5"	3/4"	LASZ-1250-JR	L2SZ-1250-JR	25/JAR
1/2"	6"	3/4"	LASZ-1260-JR	L2SZ-1260-JR	25/JAR

Pilot Hole Sizes: Softwood = 3/8" Hardwood = 7/16"





# HEX NUTS

## MACHINE SCREW NUTS



Hex machine screw nuts are used for fastening to a bolt when mechanically joining materials together. This type refers to nuts used with smaller machine screw sizes under 1/4". Machine screw nuts are designed to be used with machine screws.

AVAILABLE IN



CONTRACTOR BUCKETS

SCREW SIZE	THREAD PITCH	ACROSS FLATS	GRADE 2 ZINC PLATED	18-8 STAINLESS	316 STAINLESS	PKG
6	32	.305	NTHN-0632-JR	N2HN-0632-JR	N3HN-0632-JR	100/JAR
8	32	.335	NTHN-0832-JR	N2HN-0832-JR	N3HN-0832-JR	100/JAR
10	24	.368	NTHN-1024-JR	N2HN-1024-JR	N3HN-1024-JR	100/JAR
10	32	.368	NTHN-1032-JR	N2HN-1032-JR	N3HN-1032-JR	100/JAR

## FINISHED HEX NUTS



Hex nuts are for general applications and are used with bolts and washers of the same finish. The most commonly used nut, they are often found in general assembly where low stress fastening is required.

AVAILABLE IN



CONTRACTOR BUCKETS

SCREW SIZE	THREAD PITCH	ACROSS FLATS	GRADE 2 ZINC PLATED	18-8 STAINLESS	316 STAINLESS	PKG
1/4"	20	.430	NTHN-1420-JR	N2HN-1420-JR	N3HN-1420-JR	100/JAR
5/16"	18	.490	NTHN-5618-JR	N2HN-5618-JR	N3HN-5618-JR	100/JAR
3/8"	16	.555	NTHN-3816-JR	N2HN-3816-JR	N3HN-3816-JR	100/JAR
1/2"	13	.740	NTHN-1213-JR	N2HN-1213-JR	N3HN-1213-JR	100/JAR

## COUPLING NUTS



Coupling Nuts are elongated nuts used to connect pieces of threaded rod or other male threaded fasteners. They are similar to hex nuts with extreme height measurements giving it length. The coupling nut joins two pieces of threaded rod.

AVAILABLE IN



CONTRACTOR BUCKETS

SCREW SIZE	THREAD PITCH	ACROSS FLATS	LENGTH	GRADE 2 ZINC PLATED	18-8 STAINLESS	316 STAINLESS	PKG
1/4"	20	.370	7/8"	NTCO-1420-JR	N2CO-1420-JR	N3CO-1420-JR	100/JAR
5/16"	18	.430	7/8"	NTCO-5618-JR	N2CO-5618-JR	N3CO-5618-JR	100/JAR
3/8"	16	.615	1-1/8"	NTCO-3816-JR	N2CO-3816-JR	N3CO-3816-JR	100/JAR
1/2"	13	.670	1-1/4"	NTCO-1213-JR	N2CO-1213-JR	N3CO-1213-JR	100/JAR



Visit us on the web at [www.posi-tech.com](http://www.posi-tech.com)



# WASHERS

## USS FLAT WASHERS



Washers are typically used to bear the load of a threaded fastener, often a screw or a nut. United States Standard or USS Flatwashers were developed to satisfy engineering requirements in the majority of industrial applications in all fields of manufacturing, maintenance and repair. No. 6 and No. 8 available as SAE only.



CONTRACTOR BUCKETS

SCREW SIZE	O.D.	THICKNESS	GRADE 2 ZINC	18-8 STAINLESS	316 STAINLESS	PKG
6	3/8"	.032	WAFL-0600-JR	W2FL-0600-JR	W3FL-0600-JR	100/JAR
8	1/2"	.038	WAFL-0800-JR	W2FL-0800-JR	W3FL-0800-JR	100/JAR
10	5/8"	.045	WAFL-3600-JR	W2FL-3600-JR	W3FL-3600-JR	100/JAR
1/4"	3/4"	.065	WAFL-1400-JR	W2FL-1400-JR	W3FL-1400-JR	100/JAR
5/16"	7/8"	.080	WAFL-5600-JR	W2FL-5600-JR	W3FL-5600-JR	100/JAR
3/8"	1"	.080	WAFL-3800-JR	W2FL-3800-JR	W3FL-3800-JR	100/JAR
1/2"	1-3/8"	.105	WAFL-1200-JR	W2FL-1200-JR	W3FL-1200-JR	100/JAR

## FENDER WASHERS



A fender washer, though similar in shape to a standard washer, differs in that the outside diameter is traditionally much larger in proportion to the center hole. With this design, a fender washer can be placed under the head of a bolt or nut to help distribute forces applied when tightening.



CONTRACTOR BUCKETS

SCREW SIZE	O.D.	THICKNESS	GRADE 2 ZINC	18-8 STAINLESS	316 STAINLESS	PKG
3/16"	1"	.051-.079	WAFN-3610-JR	W2FN-3610-JR	W3FN-3610-JR	100/JAR
1/4"	1"	.051-.079	WAFN-1410-JR	W2FN-1410-JR	W3FN-1410-JR	100/JAR
1/4"	1-1/4"	.051-.079	WAFN-1412-JR	W2FN-1412-JR	W3FN-1412-JR	100/JAR
1/4"	1-1/2"	.051-.079	WAFN-1415-JR	W2FN-1415-JR	W3FN-1415-JR	100/JAR
1/4"	2"	.051-.079	WAFN-1420-JR	W2FN-1420-JR	N/A	100/JAR
5/16"	1"	.051-.079	WAFN-5610-JR	W2FN-5610-JR	W3FN-5610-JR	100/JAR
5/16"	1-1/4"	.051-.079	WAFN-5612-JR	W2FN-5612-JR	W3FN-5612-JR	100/JAR
3/8"	1"	.051-.079	WAFN-3810-JR	W2FN-3810-JR	W3FN-3810-JR	100/JAR
3/8"	1-1/4"	.051-.079	WAFN-3812-JR	W2FN-3812-JR	W3FN-3812-JR	100/JAR
3/8"	1-1/2"	.051-.079	WAFN-3815-JR	W2FN-3815-JR	W3FN-3815-JR	100/JAR
3/8"	2"	.051-.079	WAFN-3820-JR	W2FN-3820-JR	N/A	100/JAR
1/2"	1-1/2"	.051-.079	WAFN-1215-JR	W2FN-1215-JR	W3FN-1215-JR	100/JAR
1/2"	2"	.051-.079	WAFN-1220-JR	W2FN-1220-JR	W3FN-1220-JR	100/JAR

## SPLIT LOCK WASHERS



The "Split" in the helical spring lock washer absorbs initial driving torque and visually closes under nominal bolt loading. When tension in the assembly is reduced and loosening occurs, it provides resistance to the back-off rotation of the screw



CONTRACTOR BUCKETS

SCREW SIZE	O.D.	THICKNESS	GRADE 2 ZINC	18-8 STAINLESS	316 STAINLESS	PKG
6	.250	.031	WASL-0600-JR	W2SL-0600-JR	W3SL-0600-JR	100/JAR
8	.293	.040	WASL-0800-JR	W2SL-0800-JR	W3SL-0800-JR	100/JAR
10	.334	.047	WASL-3600-JR	W2SL-3600-JR	W3SL-3600-JR	100/JAR
1/4"	.487	.062	WASL-1400-JR	W2SL-1400-JR	W3SL-1400-JR	100/JAR
5/16"	.583	.078	WASL-5600-JR	W2SL-5600-JR	W3SL-5600-JR	100/JAR
3/8"	.680	.094	WASL-3800-JR	W2SL-3800-JR	W3SL-3800-JR	100/JAR
1/2"	.869	.125	WASL-1200-JR	W2SL-1200-JR	W3SL-1200-JR	100/JAR



# WASHERS

## SERRATED TOOTH LOCK WASHERS



External Tooth Lock Washers or external lockwashers provide maximum torsional resistance. These lock washers work best with large head screws such as pan, truss and washer heads.

AVAILABLE IN



CONTRACTOR BUCKETS

SCREW SIZE	I. D.	O. D.	THICKNESS	GRADE 2 ZINC PLATED	18-8 STAINLESS	PKG
6	.150	5/16"	.022	WAST-0600-JR	W2ST-0600-JR	100/JAR
8	.176	3/8"	.023	WAST-0800-JR	W2ST-0800-JR	100/JAR
10	.204	7/16"	.024	WAST-3600-JR	W2ST-3600-JR	100/JAR
1/4"	.267	1/2"	.028	WAST-1400-JR	W2ST-1400-JR	100/JAR
5/16"	.332	9/16"	.034	WAST-5600-JR	W2ST-5600-JR	100/JAR
3/8"	.398	5/8"	.040	WAST-3800-JR	W2ST-3800-JR	100/JAR
1/2"	.530	7/8"	.045	WAST-1200-JR	W2ST-1200-JR	100/JAR

## BELLEVILLE CONICAL SPRING WASHERS



Belleville Washers are disks of metal that are formed in an conical shape so that when the washer is loaded, it deflects, acting like a spring, providing a preload between two surfaces. These washers also provide continual pressure in the presence of vibration or thermal expansion, lessening the chances of decoupling..

AVAILABLE IN



CONTRACTOR BUCKETS

SCREW SIZE	I. D.	O. D.	THICKNESS	GRADE 2 ZINC PLATED	18-8 STAINLESS	PKG
1/4"	.260	5/8"	.030	WABV-1400-JR	W2BV-1400-JR	100/JAR
5/16"	.354	3/4"	.040	WABV-5600-JR	W2BV-5600-JR	100/JAR
3/8"	.400	3/4"	.085	WABV-3800-JR	W2BV-3800-JR	100/JAR
1/2"	.551	1"	.070	WABV-1200-JR	W2BV-1200-JR	100/JAR

## NEOPRENE BONDED WASHERS



Bonded washers or sealing washers are used in applications that require a stronger seal than conventional washers might provide. Bonded washers are slightly conical metal washers with a bonded neoprene or EPDM rubber backing. They are available in steel and stainless steel and in a range of sizes.

AVAILABLE IN



CONTRACTOR BUCKETS

SCREW SIZE	I. D.	O. D.	THICKNESS	GRADE 2 ZINC PLATED	18-8 STAINLESS	PKG
1/4"	.260	5/8"	.098	WANB-1400-JR	W2NB-1400-JR	100/JAR
5/16"	.354	3/4"	.102	WANB-5600-JR	W2NB-5600-JR	100/JAR
3/8"	.400	3/4"	.115	WANB-3800-JR	W2NB-3800-JR	100/JAR
1/2"	.551	1"	.122	WANB-1200-JR	W2NB-1200-JR	100/JAR

## NEOPRENE WASHERS



SCREW SIZE	O. D.	THICKNESS	NEOPRENE	PKG
1/4"	1/2"	1/4"	WANE-1400-JR	100/JAR
3/8"	5/8"	1/4"	WANE-3800-JR	100/JAR
1/2"	1"	1/4"	WANE-1200-JR	100/JAR
1/4"	1-1/4"	1/16"	WANE-1400-JR	100/JAR
3/8"	1-1/4"	1/16"	WANE-3800-JR	100/JAR
1/2"	2"	1/16"	WANE-1200-JR	100/JAR

AVAILABLE IN



CONTRACTOR BUCKETS



# FASTENER KITS



## ROUND HEAD MACHINE SCREWS ZINC

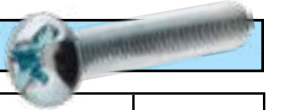

PART NO	DIA	DRIVE	DESCRIPTION	PCS
MCKT-6345	6-32	COMBO	100 - 1/2", 75 - 3/4", 75 - 1" 50 - 1-1/4" 40 - 1-1/2", 30 - 2"	370
MCKT-8345	8-32	COMBO	100 - 1/2", 60 - 3/4", 50 - 1" 40 - 1-1/4", 35 - 1-1/2", 25 - 2"	310
MCKT-1325	10-32	COMBO	75 - 1/2", 50 - 3/4", 40 - 1" 30 - 1-1/4", 25 - 1-1/2", 25 - 2"	245
MCKT-1415	1/4-20	COMBO	30 - 1/2", 25 - 3/4", 20 - 1" 15 - 1-1/4", 10 - 1-1/2", 10 - 2"	110

## FLAT HEAD MACHINE SCREWS



PART NO	DESCRIPTION	PCS
MFKT-6345	100 - 1/2", 75 - 3/4", 75 - 1", 50 - 1-1/4", 40 - 1-1/2", 30 - 2"	345

## HEX NUTS ZINC



PART NO	DESCRIPTION	PCS
NTKH-0325	70 - 6-32", 50 - 8-32", 50 - 10-24" 50 - 10-32", 75 - 1/4", 30 - 3/8"	325

## USS FLAT WASHERS ZINC



PART NO	DESCRIPTION	PCS
WAKT-0485	120 - #6, 120 - #8, 120 - #10 75 - 1/4", 25 - 5/16", 25 - 3/8"	485

## SPLIT LOCK WASHERS ZINC



PART NO	DESCRIPTION	PCS
WSKT-0485	120 - #6, 120 - #8, 120 - #10 75 - 1/4", 25 - 5/16", 25 - 3/8"	485





# FASTENER KITS



## FENDER WASHERS ZINC

PART NO	DESCRIPTION	PCS
WFKT-0120	40 - 3/16 x 1", 40 - 1/4 x 1-1/4" 40 - 3/8 x 1-1/4"	120

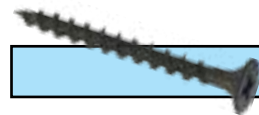

## DRYWALL SCREWS COARSE BLACK

PART NO	DESCRIPTION	PCS
DWKT-0180	50 - 6 x 1", 40 - 6 x 1-1/4", 30 - 6 x 1-5/8" 20 - 6 x 2", 20 - 6 x 2-1/4", 20 - 8 x 2-1/2"	180



## HEX HEAD SELF-DRILL SCREWS ZINC

PART NO	DESCRIPTION	PCS
HTKT-0295	75 - 8 x 1/2", 50 - 8 x 3/4", 40 - 8 x 1" 50 - 10 x 1/2", 50 - 10 x 3/4", 30 - 10 x 1"	295



## HEX HEAD SHEET METAL SCREWS ZINC

PART NO	DESCRIPTION	PCS
HSKT-0295	75 - 8 x 1/2", 50 - 8 x 3/4", 40 - 8 x 1" 50 - 10 x 1/2", 50 - 10 x 3/4", 30 - 10 x 1"	295



## MODIFIED TRUSS SHARP AND SELF-DRILL ZINC

PART NO	DESCRIPTION	PCS
MTKT-0330	SHARP: 75 - 8 x 1/2", 50 - 8 x 3/4", 40 - 8 x 1" SELF-DRILL: 75 - 8 x 1/2", 50 - 8 x 3/4", 40 - 8 x 1"	330



Visit us on the web at [www.posi-tech.com](http://www.posi-tech.com)



# APPENDIX A

## WIRE AND CABLE DIMENSIONS

GAUGE	TFN/THHN/ MTW/THWN	XHHW	RHH/RHW
18 AWG	.09	----	----
16 AWG	.10	----	----
14 AWG	.10	.14	----
12 AWG	.12	.16	.18
10 AWG	.15	.18	.20
8 AWG	.22	.24	.27
6 AWG	.26	.28	.30
4 AWG	.33	.32	.35
3 AWG	.36	.35	.38
2 AWG	.39	.38	.41
1 AWG	.45	.44	.48
1/0	.49	.48	.52
2/0	.54	.52	.56
3/0	.59	.58	.61
4/0	.65	.63	.67
250 MCM	.72	.70	.73
300 MCM	.77	.75	.78
350 MCM	.82	.80	.83
400 MCM	.87	.85	.88
500 MCM	.95	.93	.96
600 MCM	1.06	1.04	1.11
700 MCM	1.13	.88	----
750 MCM	1.16	1.14	1.22
800 MCM	1.20	----	----
900 MCM	1.26	1.00	----
1000 MCM	1.32	1.29	1.37

### Coaxial Cables

TYPE	DIA
RG-58/U	.195
RG-59/U	.242
RG-6/U	.273
RG-6/UQ	.298

### Thermostat Cable

TYPE	DIA
18/2	.136
18/3	.144
18/4	.158
18/5	.174
18/6	.184
18/7	.190
18/8	.208
18/9	.224
18/10	.227
18/12	.245

## WIRE SIZE EQUIVALENCY CHART

When sizing compression lugs for flex, DLO and welding cables, the diameter varies from that of standard building wire. The chart below will help you to find the equivalent wire size for proper lug fitment. Always check manufacturer specifications for proper termination directions and follow all safety guidelines.

CLASS B&C BUILDING WIRE	FLEX CABLE	WELDING CABLE	DLO
8 AWG	8 AWG	----	----
6 AWG	6 AWG	----	----
4 AWG	----	----	----
3 AWG	4 AWG	4 AWG	4 AWG
2 AWG	----	----	----
1 AWG	2 AWG	2 AWG	2 AWG
1/0	----	1 AWG	1 AWG
2/0	1/0	1/0	1/0
3/0	2/0	2/0	2/0
4/0	----	3/0 AWG	3/0 AWG
250 MCM	----	----	----

CLASS B&C BUILDING WIRE	FLEX CABLE	WELDING CABLE	DLO
300 MCM	4/0	4/0	4/0
350 MCM	----	----	262 MCM
400 MCM	----	----	313 MCM
500 MCM	350 MCM	----	373 MCM
600 MCM	----	----	444 MCM
650 MCM	500 MCM	----	535 MCM
750 MCM	----	----	646 MCM
800 MCM	----	----	----
900 MCM	----	----	----
1000 MCM	750 MCM	----	777 MCM



# APPENDIX B

## STUD SIZE CHART

#6		.138"	7/16"		.4375"
#8		.164"	1/2"		.500"
#10		.190"	5/8"		.625"
1/4"		.250"	3/4"		.750"
5/16"		.3125"			
3/8"		.375"			

## TAP AND DRILL COMBINATIONS

TAP SIZE	DRILL SIZE	TAP SIZE	DRILL SIZE
0-80	3/64	5/16-18	F
1-64	53	5/16-24	I
1-72	53	3/8-16	5/16
2-56	51	3/8-24	Q
2-64	50	7/16-14	U
3-48	5/64	7/16-20	25/64
3-56	46	1/2-13	27/64
4-40	44	1/2-20	29/64
4-48	42	9/16-12	31/64
5-40	39	9/16-18	33/64
5-44	38	5/8-11	17/32
6-32	36	5/8-18	37/64
6-40	33	3/4-10	21/32
8-32	29	3/4-16	11/16
8-36	29	7/8-9	49/64
10-24	25	7/8-14	13/16
10-32	21	1-8	7/8
12-24	17	1-12	59/64
12-28	15	1-14	15/16
1/4-20	7	----	----
1/4-28	3	----	----



# INDEX



## A

AEROSOL CHEMICALS 93, 94, 95  
 ALL PURPOSE LUBRICANT - THE PROTECTOR™ 95  
 ALL-PURPOSE SILICONE LUBRICANT 94  
 COIL AND FIN CLEANER 95  
 CONTACT CLEANERS 93  
 CUTTING OIL - AEROSOL 95  
 DRY FILM MOLY LUBRICANT 94  
 ELECTRICAL DEGREASER 93  
 ELECTRICAL LACQUER SEALER 93  
 ELECTRIC MOTOR DEGREASER 93  
 HEAVY DUTY CITRUS DEGREASER 95  
 MOLY CHAIN LUBRICANT 94  
 OUTDOOR METAL PROTECTANT 95  
 RED INSULATING VARNISH 93  
 RUST BREAKER 94  
 WHITE LITHIUM GREASE 94  
 AEROSOL PAINTS 91  
 GENERAL PURPOSE ENAMEL SPRAY PAINTS 91  
 SPECIALTY ACRYLIC ENAMEL SPRAY PAINTS 92  
 ALLIGATOR CLIPS 55  
 ANGLE STRUT FITTINGS 140  
 INSIDE CORNER ANGLE 45 DEGREE 140  
 INSIDE CORNER ANGLE 90 DEGREE 140  
 INSIDE CORNER ANGLE 135 DEGREE 140  
 STRUT POST BASES 140  
 APPENDIX A 175  
 WIRE AND CABLE DIMENSIONS 175  
 APPENDIX B 176  
 WIRE SIZE EQUIVALENCY CHART 176  
 APPENDIX C  
 TAP AND DRILL COMBINATIONS 176

## B

BITS AND DRIVERS 125, 126  
 HEX DRIVERS / NUT SETTERS 126  
 MAGNETIC BIT HOLDERS 126  
 PHILLIPS INSERT BITS 125  
 PHILLIPS POWER BITS 125  
 QUICK RELEASE BIT HOLDER 126  
 SECURITY BIT KITS 126  
 SLOT INSERT BITS 125  
 SOCKET ADAPTERS 125  
 SPANNER SECURITY BITS 126  
 SQUARE INSERT BITS 125  
 SQUARE POWER BITS 125  
 STAR INSERT BITS 125  
 STAR POWER BITS 125  
 STAR SECURITY BITS 126  
 BOX GROUNDING 34, 35  
 GROUNDING CLIPS 35  
 GROUNDING PUSH-IN WIRE CONNECTOR 35

GROUNDING SCREWS 35  
 GROUNDING TWIST-ON WIRE CONNECTOR 35  
 SOLID GROUNDING PIGTAILS 34  
 STRANDED GROUNDING PIGTAILS 34  
 STRANDED MTW POWER LEADS 34  
 BOX HARDWARE 36  
 BOX SUPPORTS 36  
 RECEPTACLE SPACERS 36  
 ROUND COVER PLATES 36  
 BRASS DISCONNECT TERMINALS 49  
 CHAIR STYLE 3-WAY PARALLEL 49  
 PIGGY-BACK 3-WAY IN SERIES 49  
 SIDE-BY-SIDE 3-WAY PARALLEL 49  
 STUD MOUNT TABS 49  
 BURIAL TAPES 87  
 BURIAL TAPES - DETECTABLE 87  
 BURIAL TAPES - NON-DETECTABLE 87

## C

CABLE MANAGEMENT 72, 73  
 EPDM CUSHIONED CLAMP 72  
 EXPANDABLE BRAIDED SLEEVING 73  
 SPIRAL HARNESS WRAP 73  
 SPLIT LOOM 73  
 CABLE STAPLES / NAILS 132  
 SER/SEU PLASTIC STAPLES 132  
 SINKER GENERAL CONSTRUCTION NAIL 132  
 CABLE TIES 66, 67, 68, 69, 70, 71  
 316 STAINLESS STEEL CABLE TIES 71  
 ADHESIVE BACKED MOUNTING BASES 69  
 AIR HANDLING TIES FOR PLENUM SPACES 68  
 ANCHOR MOUNT BASE 69  
 CABLE TIE REMOVAL TOOL / WIRE STRIPPER 68  
 CABLE TIE TENSIONING TOOLS 70  
 COLOR CABLE TIES 70  
 HOOK AND LOOP 71  
 IDENTIFICATION TIES 68  
 MOUNTING TIES 68  
 NATURAL CABLE TIES 66  
 SADDLE STYLE MOUNTING BASES 69  
 SIDE LASH MOUNTING BASES FOR HD TIES 69  
 STAINLESS CABLE TIE TENSIONING TOOL 71  
 UV BLACK CABLE TIES 67  
 CARGO SECURITY 111, 112  
 BUNGEE CORD ASSORTMENTS 112  
 CARGO SECURITY KIT BOX 111  
 EPDM HEAVY DUTY RUBBER TIE-DOWNS 112  
 HEAVY DUTY TARPS 112  
 RATCHET STRAPS 111  
 ROPE RATCHET TIE-DOWN 111  
 COMPRESSION LUGS 4, 5, 6, 7, 8, 9, 10, 11, 12  
 ANTI-OX FOR AL/CU CONNECTIONS 11, 98  
 COPPER BUTT SPLICE - LONG BARREL 9





# INDEX

COPPER BUTT SPLICE - STANDARD BARREL 7  
 COPPER - ONE HOLE - LONG BARREL 8, 9  
 COPPER - ONE HOLE - STANDARD BARREL 4, 5  
 COPPER - TWO HOLE - LONG BARREL 10  
 COPPER - TWO HOLE - STANDARD BARREL 6, 7  
 DUAL RATED ALUMINUM - ONE HOLE 11  
 DUAL RATED ALUMINUM SPLICE 12  
 DUAL RATED ALUMINUM - TWO HOLE 12  
 CONCRETE ANCHORS 144, 145, 146, 147  
 CALK-IN™ ANCHORS 145  
 DROP-IN ANCHORS 144  
 EXPANSION ANCHORS 146  
 LAG SHIELDS™ 145  
 PIPE SPIKES™ 144  
 PRE-CAST CONCRETE INSERTS FOR METAL SUBSTRATES 147  
 PRE-CAST CONCRETE INSERTS FOR WOOD SUBSTRATES 147  
 RAPIDSET® CALK-IN ANCHOR TOOL 145  
 SLEEVE ANCHORS 147  
 WEDGE ANCHORS 146  
 CONSTRUCTION TAPES 84  
 DUCT TAPE - CLOTH BACKED 84  
 MASKING TAPE - INDUSTRIAL GRADE 84  
 MASKING TAPE - PAINTER'S GRADE 84  
 CU MECHANICAL LUGS 23  
 FORGED POST CONNECTOR 23  
 OFFSET MECHANICAL 23  
 STRAIGHT MECHANICAL 23  
 CUTTING TOOLS 121  
 AIRCRAFT LENGTH TWIST DRILL - EXTRA LONG 121  
 HAND TAPS - CARBON STEEL 121  
 STEP DRILLS - TITANIUM COATED 121

**D**

DRYWALL SCREWS 164  
 COARSE THREAD BLACK PHOSPHATE 164  
 FINE THREAD BLACK PHOSPHATE 164

**E**

ECONOMY LUGS 14, 15  
 COPPER TIN PLATED RING 14, 15  
 COPPER TIN PLATED SPLICES 15  
 ELECTRICAL TAPES 81, 82, 83  
 30mil HIGH VOLTAGE RUBBER TAPE - W/ LINER 82  
 FRICTION TAPE 83  
 GLASS CLOTH TAPE - RUBBER ADHESIVE 83  
 LIQUID ELECTRICAL TAPE 82  
 MASTIC RUBBER WRAP 83  
 PREMIUM VINYL ELECTRICAL TAPES - BLACK 81  
 PVC ELECTRICAL TAPES - BLACK 81  
 PVC ELECTRICAL TAPES - COLORS 1/2" x 20' 81  
 PVC ELECTRICAL TAPES - COLORS 3/4" X 60 81  
 RUBBER TAPE W/ LINER 82  
 SILICONE 83

EMT STRAPS 128  
 CONDUIT HANGERS 128  
 SNAP-ON ONE HOLE 128  
 TWO HOLE 128  
 ENCLOSURE HARDWARE 137  
 3 PIECE KNOCKOUT SEALS 137  
 SNAP-IN KNOCKOUT SEALS 137  
 STEEL CONDUIT LOCKNUTS 137

**F**

FASTENER KITS 173, 174  
 DRYWALL SCREWS COARSE BLACK 174  
 FENDER WASHERS ZINC 174  
 FLAT HEAD MACHINE SCREWS 173  
 HEX HEAD SELF-DRILL SCREWS ZINC 174  
 HEX HEAD SHEET METAL SCREWS ZINC 174  
 HEX NUTS ZINC 173  
 MODIFIED TRUSS 174  
 ROUND HEAD MACHINE SCREWS ZINC 173  
 SPLIT LOCK WASHERS ZINC 173  
 USS FLAT WASHERS ZINC 173  
 FIREBLOCK PRODUCTS 89  
 RESIDENTIAL FIREBLOCK FOAM 89  
 RESIDENTIAL FIREBLOCK SEALANT 89  
 FIRESTOP PRODUCTS 88  
 COMMERCIAL FIRESTOP PILLOWS 88  
 COMMERCIAL FIRESTOP PUTTY PADS 88  
 COMMERCIAL FIRESTOP SEALANT 88  
 FIRST AID KITS 103  
 FLAT STRUT FITTINGS 139  
 CORNER SPLICE PLATES 139  
 SPLICE PLATES 139  
 SQUARE WASHERS 139  
 TEE SPLICE PLATES 139  
 FRAMING SCREWS 163  
 NEEDLE POINT 163  
 SELF-DRILLING 163

**G**

GENERAL PURPOSE TAPES 85  
 ACRYLIC CARTON SEALING TAPE 85  
 PTFE PIPE THREAD SEALING TAPE 85  
 STRETCH FILM APPLICATOR 85  
 STRETCH FILM - HAND APPLIED 85  
 GENERAL VOID FILL 89  
 DUCT SEAL 89  
 NON-FIRE RATED FOAM 89  
 GROUNDING CLAMPS 29, 30, 31, 32  
 CABLE TRAY GROUNDING CLAMP 29  
 DIRECT BURIAL WATER PIPE STYLE 30  
 DIRECT BURIAL WATER PIPE STYLE 4/0 WIRE 30  
 HEAVY DUTY ACORN STYLE 29  
 REGULAR DUTY ACORN STYLE 29



# INDEX

U-BOLT GROUNDING CLAMPS 32  
 UNIVERSAL ACORN STYLE 29  
 WATER PIPE CLAMPS 31  
 WATER PIPE CLAMPS  
 FOR ARMORED CABLE or 4/0 WIRE 31  
 WATER PIPE CLAMP w/ CONDUIT HUB 31

**H**

HEAD PROTECTION 103  
 4 POINT SUSPENSION HARD HATS 103  
 HEAT SHRINKABLE TUBING 74, 75, 76, 77, 78, 79, 80  
 CABLE REPAIR SLEEVES 78  
 COLD SHRINK 80  
 DUAL WALL POLYOLEFIN 3:1 SHRINK TUBING 75  
 HEAT GUNS 78  
 HEAT SHRINK ASSORTMENT KITS 77  
 HEAT SHRINK TS RETAIL PACKS 77  
 HEAVY WALL POLYOLEFIN 3:1 SHRINK TUBING 76  
 SUBMERSIBLE SPLICE KITS 79  
 THIN WALL POLYOLEFIN 2:1 SHRINK TUBING 74  
 HEAT SHRINK TERMINALS 51, 52  
 BUTT SPLICES 51  
 QUICK DISCONNECTS - FULLY INSULATED 52  
 QUICK DISCONNECTS - PARTIALLY INSULATED 52  
 RING TERMINALS 51  
 SPADE (FORK) TERMINALS 52  
 HEX CAP SCREWS 167  
 HEX NUTS 170  
 COUPLING NUTS 170  
 FINISHED HEX NUTS 170  
 MACHINE SCREW NUTS 170  
 HEX TAP BOLTS 168  
 HIGH-TEMP SOLDERLESS TERMINALS 49, 50  
 BUTT SPLICES 50  
 QUICK DISCONNECTS 50  
 RING TERMINALS 50  
 SPADE (FORK) TERMINALS 49  
 HOLE SAW BLADES 116  
 HOLE SAW ARBORS 116  
 HOLE SAW KITS 117

**I**

INSTALLATION TOOLS 16  
 CABLE CUTTERS 16  
 COMPRESSION TOOLING 16  
 ECONOMY HAMMER CRIMPERS 16  
 INSULATED MULTI-TAPS 26, 27  
 DIRECT BURIAL SECONDARY CONNECTORS 27  
 DIRECT BURIAL SPLICE FOR SECONDARY CONNECTORS 27  
 MULTI CONDUCTOR DUAL SIDED 26  
 INSULATED TAPS 24, 25  
 2 PORT OFFSET ENTRY 24  
 2 PORT SINGLE SIDE ENTRY 24

BUTT SPLICE 25  
 DIRECT BURIAL SECONDARY CONNECTORS 27  
 TWO CONDUCTOR DUAL SIDED 25

**L**

LAG BOLTS 169  
 LOW VOLTAGE STAPLES 133  
 BELL, THERMOSTAT, SPEAKER AND PHONE 133  
 FOR USE WITH RG-59 & RG-6 CABLES 133  
 RJ11, RJ12, RJ45, CATEGORY 4 & 5 133  
 LUBRICANTS 98  
 ANCHOR LUBE CUTTING LUBRICANT 98  
 CLEAR WIRE PULLING LUBE 98  
 DARK CUTTING OIL 98

**M**

MACHINE SCREWS 165, 166  
 FLAT HEAD PHILLIPS DRIVE 166  
 ROUND HEAD SLOT/PHILLIPS COMBO DRIVE 165, 166  
 MARKING PRODUCTS 92  
 LUMBER CRAYONS 92  
 PERMANENT MARKERS 92  
 WATER-BASED MARKING PAINTS 91  
 MASONRY DRILLS 122  
 CONCRETE SCREW MASONRY BITS 122  
 SDS / SDS PLUS 122  
 SMOOTH/ROUND SHANK 122  
 MECHANICAL ADAPTER PINS 13  
 OFFSET - DUAL RATED ALUMINUM 13  
 STRAIGHT - DUAL RATED ALUMINUM 13  
 MECHANICAL GROUNDING 33  
 DUAL RATED WATER PIPE CLAMPS 33  
 INTERSYSTEM BONDING DEVICE 33  
 LAY-IN COPPER GROUNDING LUG 33  
 MECHANICAL LUGS 17, 18, 19, 20, 21, 22  
 DOUBLE STUD - DOUBLE SET-SCREW 20  
 DUAL RANGE LUGS 20  
 FOUR (4) CONDUCTOR, DOUBLE STUD 20  
 LAY-IN COPPER GROUNDING LUG 22  
 LAY-IN DUAL RATED ALUMINUM 22  
 PANELBOARD LUGS 21  
 SINGLE (1) BARREL 17  
 SINGLE (1) BARREL, double (2) stud 17  
 SINGLE (1) BARREL, double (2) stud, twin (2) set screw 17  
 SPLICE CONNECTORS 21  
 THREE (3) CONDUCTOR, double stud 19  
 THREE (3) CONDUCTOR, DOUBLE STUD, TWIN SET-SCREW 19  
 TRANSFORMER LUG KITS 22  
 TURN PREVENT LUGS 19  
 TWO (2) BARREL, DOUBLE (2) STUD 18  
 TWO (2) BARREL, DOUBLE (2) STUD, TWIN (2) SET SCREW 18  
 TWO (2) CONDUCTOR DUAL RATED ALUMINUM 18



# INDEX



## N

- NM STAPLES 130
  - NM MULTICABLE STAPLES 130
  - NM STACKING STAPLES 130
  - NM STAPLES 130
  - NM STAPLES FOR BLOCK AND MASONRY 130
- NM STEEL STAPLES 131
  - FOR USE WITH ROMEX®, UF AND NM CABLES 131
  - INSULATED - FOR USE WITH ROMEX®, UF AND NM CABLES 131
  - SE/SEU/BX STEEL STAPLES 131

## P

- POWDER ACTUATED 150, 151
  - BX AND CONDUIT CLIPS 151
  - CEILING CLIP ASSEMBLIES 150
  - PINS 150
  - POWDERLESS PINS 151
  - POWDER LOADS 150
  - THREADED STUDS 151
- POWER TAPS 28
  - INSULATION PIERCING 28
- PPE CHEMICALS 96
  - HAND CLEANER 96
  - NATRAPEL INSECT REPELLANT 96
  - WASP AND HORNET KILLER 96
- PPE / GLOVES 102
  - EXO 102
  - GRX CONTRACTOR GLOVES 102
  - NITRILE 6MIL GLOVES 102
  - STEALTH 102
- PPE / SAFETY 101
  - CLASS 2 SAFETY VESTS 101
  - DISPOSABLE SHOE COVERS 101
  - DUST MASKS 101
  - EAR PLUGS 101
- PUSH-IN WIRE CONNECTORS 59
  - LUMINAIRE DISCONNECTS 59
  - PUSHWIRE CONNECTORS 59
- PVC ACCESSORIES 129
  - ANTI SHORT BUSHINGS 129
  - NMC CONNECTORS 129
  - PVC TWO HOLE STRAPS 129
- PVC CEMENT 97
  - CLEANERS, PRIMERS AND PARTS 97
  - MEDIUM BODY BLUE FOR WET APPLICATIONS 97
  - MEDIUM BODY CLEAR 97
  - REGULAR BODY CLEAR 97

## R

- RAZOR KNIVES 113
  - KUTTO - THE ORIGINAL SAFETY BOX CUTTER 113
  - SIMPLE BOX CUTTER 113

- TURBOFOLD - FOLDING RAZOR KNIFE 113
- TURBO X KNIFE - RETRACTABLE RAZOR KNIFE 113
- RECEPTACLE SCREWS 37
  - 6-32 OVAL PHILLIPS - STAINLESS STEEL 37
  - 6-32 OVAL SLOT - PREMIUM MATERIALS 37
  - 6-32 OVAL SLOT - ZINC PLATED STEEL
  - w/ ENAMEL BAKED HEADS 37
  - 6-32 OVAL SPANNER - STAINLESS STEEL 37
- RIGID STRAPS 127
  - SNAP-ON ONE HOLE 127
  - TWO HOLE 127
- ROD HANGERS 142, 143
  - ACCESSORIES AND TOOLING 143
  - HAGERMATE™ FOR METAL SUBSTRATE 142
  - HANGERMATE™ FOR CONCRETE SUBSTRATE 142
  - HANGERMATE™ FOR WOOD SUBSTRATE 143
- ROPE 100
  - 3 STRAND TWISTED YELLOW POLYPROPELENE 100
  - COMPOSITE DOUBLE BRAID W/EYES 100
  - WOVEN POLYESTER PULLING TAPE 100

## S

- SAFETY EYEWEAR 104
  - COMMANDO CAMO EYEWEAR 104
  - DB2 ADVANCED EYEWEAR 104
  - NSX TURBO ECONOMY EYEWEAR 104
- SAW BLADES 117
  - HACKSAW BLADES 117
  - HACKSAW FRAMES 117
  - RECIPROCATING SAW BLADES 117
- SELF-DRILLING SCREWS 161, 162
  - HEX WASHER HEAD #2 - #3 POINT 161
  - HEX WASHER HEAD #4 - #5 POINT 161
  - HEX WASHER HEAD w/NEO WASHER #4 - #5 POINT 162
  - PAN HEAD - PHILLIPS DRIVE #2 - #3 POINT 162
- SHEATHED CABLE TAP KITS 36
- SHEET METAL SCREW 158, 159, 160
  - HEX WASHER HEAD 158
  - PAN HEAD PHILLIPS DRIVE 159
  - PAN SQUARE DRIVE 160
- SIGNS AND LABELS 65
  - DANGER, ARC FLASH HAZARD 65
  - DANGER, HIGH VOLTAGE 65
  - DANGER, HIGH VOLTAGE, KEEP OUT 65
  - HIGH-VOLTAGE, AUTHORIZED PERSONNEL 65
  - WARNING, LIVE ELECTRIC 65
- SILICONE SEALANTS
  - 100% RTV SILICONE - AEROSOL 90
  - 100% SILICONE 90
  - SEALANT DISPENSING GUNS 90
- SMALL WIRE TOOLING 55
- SOLDERLESS NON-INSULATED TERMINALS 46
  - BUTT SPLICES 46

- FLAG TERMINALS 48
- FLANGED SPADE (FORK) TERMINALS 47
- QUICK DISCONNECTS 48
- RING TERMINALS 46
- SNAP SPADE (FORK) TERMINALS 47
- SPADE (FORK) TERMINALS 47
- SOLDERLESSNON-INSULATED TERMINALS 47, 48
- SOLDERLESS NYLON TERMINALS 38, 39, 40, 41
  - BUTT SPLICES 38
  - FLANGED SPADE (FORK) TERMINALS 39
  - NYLON BULLET CONNECTORS 41
  - NYLON CLOSED END "PIGTAIL" CONNECTORS 41
  - NYLON FULLY INSULATED FLAG TERMINALS 40
  - NYLON FULLY INSULATED QUICK DISCONNECTS 40
  - NYLON QUICK DISCONNECTS 40
  - SNAP SPADE (FORK) TERMINALS 39
  - SPADE (FORK) TERMINALS 39
- SOLDERLESS TERMINAL KITS 54
- SOLDERLESS VINYL TERMINALS 42, 43, 44, 45
  - BULLET CONNECTORS 45
  - FLANGED SPADE (FORK) TERMINALS 44
  - PIGGY BACK TERMINALS 45
  - PIN TERMINALS 45
  - QUICK DISCONNECTS 45
  - SNAP SPADE (FORK) TERMINALS 44
  - SOLDERLESS RING TERMINALS - BRAZED SEAM 43
  - SOLDERLESS VINYL BUTT SPLICES 42
  - SOLDERLESS VINYL BUTT SPLICES - BRAZED SEAM 43
  - SOLDERLESS VINYL RING TERMINALS 42
  - SPADE (FORK) TERMINALS 44
- SPLIT BOLTS 2, 3
  - COPPER TO COPPER 2
  - COPPER TO COPPER 3-WIRE 2
  - DUAL RATED - ALL COMBINATIONS 3
  - DUAL RATED - ALUMINUM AND COPPER (UL) 3
- STRUT ACCESSORIES 138
  - CHANNEL NUTS 138
  - RIGID STRUT STRAPS 138
  - UNIVERSAL STRUT STRAPS 138
- STUD GUARDS 136
  - 1-1/2" WIDE 136
  - 1-1/2" WIDE FHA PLATES 136
  - 3" WIDE 136

## T

- TERMINAL STRIPS 63
  - barrier strips - double row 63
  - euro style - touch safe 63
- THREADED ANCHORS 148, 149
  - ACOUSTICAL SCREWS 149
  - CONCRETE SCREWS - FLAT HEAD - PHILLIPS DRIVE 148
  - CONCRETE SCREWS - HEX WASHER HEAD (W/ SLOT) 148
  - CONCRETE SCREW TOOL KIT 148

- LEAD WOOD SCREW ANCHORS 149
- WEDGE BOLT™ 149
- THREADED ROD AND CLAMPS 134
  - 18-8 STAINLESS STEEL 134
  - 316 STAINLESS STEEL 134
  - BEAM CLAMPS 134
  - ZINC PLATED - ASTM A36 STEEL 134
- TOOLS AND SUPPLIES 114, 115
  - BATTERIES 115
  - CONDUIT BENDING LEVELS 115
  - PVC SAWS / CUTTERS 114
  - SAVAGE™ CONDUIT BENDING LEVELS 115
  - UGLY'S ELECTRICAL REFERENCE SERIES 114
- TS PACK SOLDERLESS TERMINALS 53, 54
  - BUTT SPLICES - TS RETAIL PACKS 53
  - RING TERMINALS - TS RETAIL PACKS 53
  - SPADE (FORK) TERMINALS - TS RETAIL PACKS 53, 54
- TURNED STEEL FASTENERS 141
  - EYE BOLTS 141
  - U-BOLTS 141
- TWIST DRILLS 118, 119, 120
  - FRACTIONAL - JOBBER LENGTH 118
  - GATOR HIDE TWIST DRILL INDEX 120
  - LETTERS - JOBBER LENGTH 119
  - NUMBERS - JOBBER LENGTH 119
  - TWIST DRILL INDEX KITS 120

## V

- VOICE & DATA 105, 106, 107, 108, 109, 110
  - BEAN CONNECTORS 106
  - COMPRESSION F CONNECTORS 108
  - DECORATOR F81 COAXIAL PLATES 107
  - DECOR RJ11 TELEPHONE WALL PLATES 105
  - F81 COAXIAL KEYSTONE JACK 109
  - F81 COAXIAL WALL PLATES 107
  - F CONNECTORS 108
  - F TYPE COAXIAL GROUNDING BLOCKS 107
  - F TYPE COAXIAL SPLITTERS 107
  - IDC CONNECTORS 106
  - KEYSTONE BLANK 109
  - KEYSTONE PLATES 109
  - NETWORKING TOOL KIT 110
  - RJ11 6P4C CONNECTORS - VOICE 106
  - RJ11 / F81 COMBO WALL PLATES 105
  - RJ11 TELEPHONE WALL PLATES 105
  - RJ45 8P8C CONNECTORS AND STRAIN RELIEFS 110
  - RJ45 8P8C KEYSTONE JACK 109
  - RJ45 8P8C SPLICE 110
  - SPLITTERS AND SPLICES 106
  - TOOLING 106, 108, 110





# INDEX

- W
- WAFER HEAD SCREWS 163
    - NEEDLE POINT MODIFIED TRUSS 163
    - SELF-DRILLING MODIFIED TRUSS 163
  - WALL ANCHORS 152, 153, 154, 155, 156, 157
    - 1/4" CONICAL ANCHOR KIT 156
    - 1/4" SUPER RIBBED ANCHOR KIT 156
    - 3/16" CONICAL ANCHOR KIT 156
    - 5/16" CONICAL ANCHOR KIT 156
  - CONICAL ANCHORS 157
  - EASY DRYWALL ANCHOR KITS 154
  - EASY DRYWALL ANCHORS 154
  - HAMMER DRIVE ANCHORS 155
  - HAMMER SCREW ANCHORS 155
  - HOLLOW WALL POLLY ANCHORS 153
  - NYLON NAIL ANCHORS 155
  - PLASTIC TOGGLES 153
  - SHARKIE SELF-MOLDING ANCHORS 157
  - SNAPTOGGLES 153
  - SUPER RIBBED EXPANDING ANCHOR 157
  - TOGGLE BOLTS 152
  - TOGGLE WINGS (WITHOUT SCREWS) 152
  - TRUSS HEAD SLOT/PHIL MACHINE SCREWS 152
  - WALL DOG DRYWALL ANCHORS 154
  - WARNING TAPES 86
    - BARICADE TAPES 86
    - BARRICADE TAPE DISPENSER 86
    - NEON FLAGGING TAPE 86
  - WASHERS 171, 172
    - BELLVILLE CONICAL SPRING WASHERS 172
    - FENDER WASHERS 171
    - NEOPRENE BONDED WASHERS 172
    - NEOPRENE WASHERS 172
    - SERRATED TOOTH LOCK WASHERS 172
    - SPLIT LOCK WASHERS 171
    - USS FLAT WASHERS 171
  - WIRE CONNECTORS 56, 57, 58, 60
    - CERAMIC HIGH TEMP TWIST-ON CONNECTOR 57
    - COMPACT LOCKING PUSHWIRE CONNECTORS 58
    - COPPER CRIMP SLEEVES 58
    - DIRECT BURIAL - SILICONE FILLED 57
    - GROUNDING TWIST-ON CONNECTOR 56
    - HIGH TEMP TWIST-ON CONNECTOR 57
    - IDC TAP CONECTORS 60
    - IDC T-TAP CONNECTOR 60
    - LEVER-NUT PUSH-IN WIRE CONNECTOR 58
    - MOISTURE RESISTANT IDC CONECTORS 60
    - STEEL CRIMP SLEEVES 58
    - TWIST-ON WIRE CONNECTOR 56
    - WING STYLE TWIST-ON WIRE CONNECTOR 56
    - WRAP CAPS 58
  - WIRE FASTENERS 135
    - FIXTURE HANGERS 135
  - JACK CHAIN 135
  - TIE WIRE 135
  - WIRE FERRULES 61, 62
    - DOUBLE WIRE FERRULES 61
    - NON-INSULATED FERRULES 62
    - SINGLE WIRE FERRULES 61
    - WIRE FERRULE KITS 62
    - WIRE FERRULE TOOLS 62
  - WIRE IDENTIFICATION 64
    - voltage marker labels - self adhesive 64
    - wire marker books 64
  - WIRE PULLING SUPPLIES 99
    - CONDUIT MEASURING TAPE 99
    - PULLING TWINE 99
    - PULL LINE CONDUIT CARRIERS 99
    - SEINE TWINE 99
  - WOOD BORING 123, 124
    - AUGER BITS 123
    - EXTENSION 124
    - NAIL BUSTER AUGER BITS 123
    - SPADE BITS 124
  - WOOD SCREWS 164

Edited by  
Elizabeth Bombly and Todd McCarty



**POSİ-TECH**  
Positive Technologies, Inc.  
Electrical Hardware for the Professional



## Manufacturer Warranty

Positive Technologies, Inc. (Posi-tech) warrants products to be free from defects in workmanship and material for a period of one year from the date of delivery to the purchaser buying direct from Positive Technologies, Inc. or it's authorized distributor. This warranty includes, but is not limited to, those products manufactured to a specification supplied by the purchaser. Any defects appearing more than one year from the date of delivery to the purchaser shall be deemed wear and tear. Positive Technologies, Inc. assumes no risk or liability for the suitability or unsuitability or results of the use of its products used in combination with any electrical or electronic components, circuits, systems, mechanical devices, construction projects, assemblies, or any other material or substances or environments. The purchasers right under this warranty shall consist solely of requiring Positive Technoogies, Inc. to repair, or in Positive Technologies, Inc.'s sole discretion, replace, free of charge, FOB factory, any defective items received at it's factory within said year, as determined by Positive Technologies, Inc., to be defective.

All products to be returned to Positive Technologies, Inc., For evaluation under this warranty shall first receive return authorization from Positive Technologies, Inc. All products returned without authorization may be returned at senders expense. The failure to give, or the giving of any advice or recommendations by Positive Technologies, Inc. shall not constitute any warranty by, or impose any liability upon Positive Technologies, Inc.. The sole and exclusive remedy of the purchaser and the exclusive liability of Positive Technologies, Inc., are outlined and stated above, and is in lieu of any and all other warranties expressed, implied, or statutory as to merchantability, fitness for the purpose sold, description, quality, productiveness, or any other matter. In no event shall Positive Technologies, Inc. be liable for consequential or special damages, or for the delay in the performance of this warranty.

The information contained within this catalog and the functions offered are intended to provide information about products available for purchase from Positive Technologies, Inc. All reasonable efforts have been made to ensure the accuracy of the information. Positive Technologies, Inc. cannot be held responsible for any errors or unexpected un-fulfillment of shipments. Positive Technologies, Inc. does not warrant the accuracy and reserves the right to make changes to the catalog and at any time without notice.

Posi-tech 800-548-6728 Fax: 800-457-5156 email: sales@posi-tech.com  
Copyright Positive Technologies, Inc 2018



# POSI<sup>+</sup>-TECH

POSITIVE TECHNOLOGIES, INC.

Electrical Hardware for the Professional

 [www.posi-tech.com](http://www.posi-tech.com)